

RADIO'S LIVEST MAGAZINE



July
25 Cents
Canada 30¢

Radio-Craft

HUGO GERNSBACK Editor

Building and Operating
the New
**"TREASURE"
FINDER**
See Page 8



New Tube Data—Copper-Oxide Rectifiers—Building an Auto-Radio Set
Point-to-Point Capacity Testing—How to Make a Good Cutting Head

A COMPLETE RADIO SERVICE FOR DEALERS

THE HOUSE OF MANY BARGAINS—EVERYTHING AS ADVERTISED



The Champion AC-DC

For home, office, farm, AUTO, 6 volt, 32 volt, 110 volt. 25 and 60 cycle.

Write for particulars—you can now have an auto radio at very little cost.

The Champion is interchangeable—AC or DC current or with batteries. Latest type tubes, headless cord. Latest features are employed in making this set the most versatile and economical set ever built. Type tubes used are 36-35-78-1223.

\$9.45

Price complete with tubes.....

Auto cable for use in car.....\$1.59

INTERNATIONAL TUBE TESTER AND REJUVENATOR

Actually rejuvenates tubes, and an efficient tube tester. A 2-unit outfit in one! Increase your tube sales with this profitable making item.

\$15.00

Price.....
Dealers: Write for quantity Prices.



Pioneer Gen-E-Motor Auto "B" Eliminator

The original Gen-E-Motor. A highly efficient. Improved dynamotor for auto-radio and farm use. Self-lubricating, built in filter. Absolutely noiseless—very compact.

Dimensions are 3 1/2" high; 5 1/4" wide; 5 7/8" long. Weighs only 10 lbs.

\$9.70

Your Price.....

International Short Wave Converter. Will operate on any type of antenna and radio having a normal broadcast range of 500 miles or over. Actually operates on ten meters wavelength. Can be made a special order to operate on 220 volts, 32 volts, or 6 volts.

Operates on AC or DC. 60 cycle or 25 cycle—4 position wavelength switch. Comes in attractive metal cabinet (Beautiful walnut cabinet \$1.00 extra). Complete with 2 latest type tubes.....

\$6.95



Champion All-Electric Auto Radio

A five tube super-heterodyne—automatic volume control and full electrodynamic speaker. Carter remote control. Only one bolt to fasten and one wire to connect. Installed in a jiffy. Latest type tubes used. 6A7-6B7-41-78-84. Complete with suppressors and H. C. A. tubes.

\$19.95

Your Price.....



Audio Transformer 3 to 1—small size, will fit anywhere. Your price..... **25c**

Thornderson 3 1/4 to 1 fully shielded transformer. Your Price..... **25c**

Sangomo—push pull speaker output transformer. Your Price..... **45c**



Jefferson sealed Audio frequency transformer 2 to 1 and 3 to 1 ratio.

Your price..... **65c**
Fully shielded Philco output transformer..... **52c**

Power Transformer No. 9593R—



carries the following tubes—7-24 or 27; 2-45 or 47; 1-80 or 83 and 750 V.C.T. This transformer fully shielded and can be used for as many as 12 tubes. Your Price

\$1.95

Limited Quantity

Donsan all enclosed Push-Pull output and input transformer..... Your Price **65c**
Dongan chokes to match..... Your Price **45c**
800 volt condenser block total 800 M.F.D. Your Price **75c**

Tunk-Sol multiple condenser in cans. 4, .1, and .5 Your Price **25c**
Dual condensers—.1, 300 volts..... Your Price **15c**
Condenser—small size in cans 1..... **7c**
Condenser—small size in cans .3..... **5c**

A 25% deposit required with each order. Balance C. O. D. All items advertised. Satisfaction guaranteed.

Power packs— Filter packs— Power supply packs

ZE-182—25 Cycle—Power Pack
ZE-18—60 Cycle—Power Pack
ZE-18X—60 Cycle—Power Pack
ZE-16—Filter Pack—25 cycle
ZE-15—Power Pack—25 cycle
ZE-13—Power Pack—25 cycle
ZE-12—Power Pack—60 cycle
ZE-12X—Power Pack—60 cycle
ZE-10—Power Pack—60 cycle
ZE-8—Filter system for 8 tube loop electric set



ZE-8P—Filter system for 8 tube loop electric set
ZE-4—Power supply for Model 27 receiver
ZE-3—A Battery Eliminator 15 volt—60 M. A.
Your Price. **\$3.95**

Service Carbon Resistors—RMA Color-Coded.



Can furnish in all values from 100 ohm to 3 meg ohm.
1/5 and 1/3 watt.....3c each. \$2.50 per 100
1/2 watt.....4c each. \$3.25 per 100
1 watt.....5c each. \$3.95 per 100
Assorted sizes in 1000 lots.....\$29.50



AC Grooved Toggle Switch 1/2" sleeve—single pole
Your Price **9c** each

E-Z Toon Vernier dial. Black and Brown—3"..... **10c**

1/4" hole for shaft—5"..... **17c**

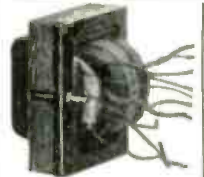

Transformer No. 1443—2 1/2 volt set 8 amps. —5 volt at 3 amps. for 83 tube. **\$1.45**
750 V.C.T. 60 cycle.

Same as above **\$1.65** in 25 cycle—

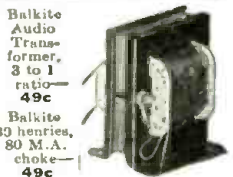
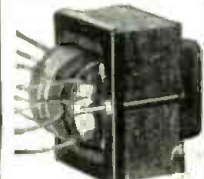

Bulkite Audio Transformer, 3 to 1 ratio. **49c**

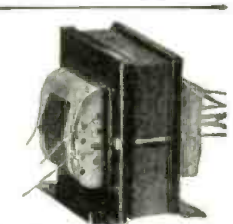

Bulkite 30 henries, 80 M.A. choke. **49c**

Thornderson No. 3022A—carries the following tubes—4-26; 9-27; 2-71; 1-80. Limited Quantity. Your Price **\$1.75**

Thornderson No. 3773—fully shielded carries the following tubes—2-50; 2-41; 6-tube type tubes—1200 V. C. T. Your Price **\$1.95**

DEALERS: We carry many more wonderful bargains. If you don't see what you want, write to us. That's part of our service to you.

SERVICE MEN'S SALES CO.

1621 So. Michigan Ave.

Dept. RC-7

Chicago, Ill.

LEARN RADIO IN 10 WEEKS!

PAY FOR YOUR TRAINING AFTER YOU GRADUATE

I am making an offer that no other school has dared to do. I'll take you here in my shops and give you this training and you pay your tuition after you have graduated. Two months after you complete my course you make your first payment, and then you have ten months to complete your payments. There are no strings to this offer. I know a lot of honest fellows haven't got a lot of money these days, but still want to prepare themselves for a real job so they won't have to worry about hard times or lay offs.

I've got enough confidence in these fellows and in my training to give them the training they need and pay me back after they have their training.

If you who read this advertisement are really interested in your future here is the chance of a life time. Mail the coupon today and I'll give you all the facts.



A scene in the big, busy Radio Shops at Coyne. Here you see fellows working on real Radios—not reading about them from books or lessons. This is THE way to prepare for the big-money field of Radio!

TELEVISION *and* TALKING PICTURES

Television is already here! Soon there'll be a demand for THOUSANDS of TELEVISION EXPERTS! The man who learns Television now can have a great future in this great new field. Get in on the ground-floor of this amazing new Radio development! Come to COYNE and learn Television on the very latest, newest Television equipment. Talking Picture and Public Address Systems offer opportunities to the Trained Radio Man. Here is a great new Radio field just beginning to grow! Prepare NOW for these wonderful opportunities! Learn Radio Sound Work at Coyne on actual Talking Picture and Sound Reproduction equipment.

PREPARE NOW and be ready for Radio's many opportunities

Forget pay-outs—lay-offs—unemployment! Don't be tied down to an untrained man's future. You NEED TRAINING IN A FAST-GROWING MONEY-MAKING TRADE. Here's your chance of a lifetime to get it! Hundreds of opportunities now open in Radio. My sensational offer, explained below, makes it possible for you to START AT ONCE!

The right way to learn Radio is the Coyne way—not by books, but by actual, practical work on actual Radio, Television and Sound equipment. Here at Coyne you'll service and operate scores of modern Radio receivers, huge Broadcasting equipment, late type Television apparatus, Talking Picture machines, Code transmitters and receivers, etc. In 10 weeks you can step into a REAL JOB, leading to a salary of \$50 a week and UP!

ALL PRACTICAL WORK At COYNE in Chicago

ALL ACTUAL, PRACTICAL WORK. You build radio sets, install and service them. You actually operate great Broadcasting equipment. You construct Television Receiving Sets and actually transmit your own Television programs over our modern Television equipment. You work on real Talking Picture

machines and Sound equipment. You learn Wireless Operating on actual Code Practice apparatus. We don't waste time on useless theory. We give you the practical training you'll need—in 10 short, pleasant weeks.

MANY EARN WHILE LEARNING

You get Free Employment Service for Life. And don't let lack of money stop you. Many of our students make all or a good part of their living expenses while going to school and if you should need this help just write to me. Coyne is 33 years old. Coyne Training is tested—proven beyond all doubt. You can find out everything absolutely free. Just mail coupon for my big free book!

H. C. LEWIS, Pres. RADIO DIVISION Founded 1899
COYNE ELECTRICAL SCHOOL
500 S. Paulina St., Dept. B3-8H Chicago, Ill.

Mail Coupon Today for All the Facts

H. C. LEWIS, President
Radio Division, Coyne Electrical School
500 S. Paulina St., Dept. B3-8H Chicago, Ill.

Dear Mr. Lewis: Send me your big FREE Book; details of your FREE Employment Service; and tell me all about your special offer of allowing me to pay for training on easy monthly terms after graduation.

Name.....
Address.....
City..... State.....



HUGO GERNSBACK, Editor-in-Chief

LOUIS MARTIN
Associate Editor

R. D. WASHBURNE
Technical Editor

CONTENTS OF THE JULY, 1933, ISSUE

VOLUME V NUMBER I

Editorial: Summer Radio.....	Hugo Gernsback	7
How to Build the New "Treasure" Finder.....	E. Franklin Sarver	8
The N.R.I.—Philco Set Tester.....		11
Postal "Universal" Auto Kit Set.....		11
Latest Radio Equipment.....		12
New Tube Data.....	Louis Martin	14
Applications and Characteristics of Copper-Oxide Rectifiers.....	B. R. Hill	18
Building the Simplicity Analyzer Unit.....	Sol. D. Prensly	20
Building A Powerful 9-Tube "Transformer-less" A.C.-D.C. Superheterodyne.....	Leon J. Littmann	22
Building the Find-All Car-Radio Set.....	H. G. Cisin	24
Point-To-Point Capacity Testing.....	Allen Beers	26
Constructing A Home Recording Cutting Head.....	W. C. Cheney	29
Building An A.C.-Operated V. T. Voltmeter.....	C. B. Brown	30
Locating and Correcting Troubles in Phonograph Pickups.....	R. F. Lambert	31
Operating Notes.....	Bertram M. Freed	32
RADIO SERVICE DATA SHEETS:		
No. 93—Motovox Models 10A All-Electric and 10E Battery-Operated "Moto-Tetradynes".....		34
No. 94—General Electric K-40A, Pilot B-2 and Emerson 20A and 25A A.C.-D.C. Sets.....		35
An Improved Power Crystal Set.....	Francis R. Harris	36
Readers' Department.....		37
The DX Listener's Forum.....		38
RADIO-CRAFT'S Information Bureau.....		39
Book Reviews.....		55
Hum Elimination.....		58

IN OUR NEXT FEW ISSUES:

A PORTABLE SERVICE KIT. Do you know how to test tubes without recourse to a meter? If you don't, now is the time to refer to the article, "The Meterless Tube Tester," in the January, 1933 issue of RADIO-CRAFT. Once you have fortified yourself with the intricacies of this modern idea in tube testing, you are prepared for the "finishing course" on a complete test equipment incorporating this method of testing. In addition, the instrument incorporates a resistance and capacity bridge, a multi-voltmeter and multi-milliammeter, and a set analyzer circuit. One of the most important observations in connection with this unit is that it doesn't require the Service Man to gallop to the nearest Ford or "Chevvy" agency for their best figure on a "serviceable, low-priced used car"—the kit is really portable!

HOW TO MAKE TRANSFORMERS. Gather unto yourself plenty of enthusiasm, brother, because we are going to give you some hot construction data concerning transformers—and how! A prominent manufacturer has consented to prepare the material especially for the readers of RADIO-CRAFT, so give him a big hand, fellows!

RADIO-CRAFT is published monthly, on the fifth of the month preceding that of date; its subscription price is \$2.50 per year. (In Canada and foreign countries, \$3.00 a year to cover additional postage.) Entered at the post office at Mt. Morris, Ill., as second-class matter under the act of March 3, 1879. Trademark and copyright by permission of Gernsback Publications, Inc., 98 Park Place, N. Y. C.

Text and illustrations of this magazine are copyright and must not be reproduced without permission of the copyright owners. We are also agents for WONDER STORIES and WONDER STORIES QUARTERLY. Subscription to these magazines may be taken in combination with RADIO-CRAFT at reduced Club rates. Write for information.

Copyright 1933. GERNSBACK PUBLICATIONS, INC.

HUGO GERNSBACK, President
S. GERNSBACK, Treasurer

J. M. HERZBERG, Vice-President
I. S. MANHEIMER, Secretary

Published by TECHNI-CRAFT PUBLISHING CORPORATION. Publication office: 404 N. Wesley Ave., Mount Morris, Illinois. Editorial and Advertising Office: 96-98 Park Place, New York City. Chicago Advertising Office: 737 North Michigan Avenue, Chicago, Ill. Western Advertising Office: 220 No. Catalina St., Los Angeles, Calif. L. F. McClure, Chicago Advertising Representative. Loyd B. Chappell, Western Advertising Representative.

London Agent: Hachette & Cie., 3 La Belle Sauvage, Ludgate Hill, E.C. 4
Paris Agent: Hachette & Cie.,
111 Rue Reaumur

Australian Agent: McGill's Agency
179 Elizabeth St., Melbourne



Mr. E. H. Scott is shown here aboard the R. M. S. Maunganui, en route to New Zealand. On this 20,000-mile cruise to the South Seas he made constant tests of broadcast band reception under greatest difficulties.

Consistent, clear reception with loudspeaker volume of stations all over the U. S. A. is the definite, verified record of Mr. Scott's spectacular test, which included ship-board operation under most trying circumstances.



IN FAR-AWAY SIAM
From Lakon Lampang, Siam, Mr. George Wyga tells of natives who called priests to expel devils which they believed kept his SCOTT silent when it had two faulty tubes. He is "pleased with the set."



A FAMOUS BAND LEADER
Columbia Chain listeners all know Frank Westphal and his music from Chicago's WBBM. He says of his SCOTT, "Such marvelous tone quality is a delightful revelation . . . it not only rivals nature, it is nature."

From All Over the World Comes
MORE AND MORE PROOF
of SCOTT Superiority

WHEN A RECEIVER consistently, day in and day out, year after year, receives the universal acclaim of owners scattered from one end of the globe to the other for the most startling spectacular performance in all radio history . . . THAT MEANS SOMETHING!

Upon the world-wide, unassailable, documentary endorsement of the legion of written, verified reports of SCOTT ALL-WAVE Deluxe owners everywhere . . . this receiver rests its case.

The few expressions reproduced here are typical of those which pour in upon us continuously. They give an inkling of how this laboratory-precision custom-built receiver stands with its owners.

World-Wide Reception Guaranteed

Because the SCOTT ALL-WAVE Deluxe is constructed by skilled engineers to give the very brand of performance reported . . . fidelity of reproduction, sensitivity almost beyond measurement, selectivity to conquer the congestion of broadcast the world around . . . it carries the strongest guarantee ever offered. It is guaranteed to receive daily, with loud speaker volume, short wave broadcasts from stations 10,000 miles or more distant . . . and its every part (except tubes) is warranted for five years.

E. H. SCOTT RADIO LABORATORIES, Inc.
4450 RAVENSWOOD AVE., Dept. C-73, CHICAGO, ILL.



IN CENTRAL MEXICO
Baron v. Turckheim reports daily reception of broadcasts from Germany, France, Spain and Australia. "The tone is faultless," he writes from Mexico City, and then adds, "This is my first great radio."



IN THE PHILIPPINES
U. S. Army Sergeant Frank Sublette, Fort Mills, Cavite, P. I., says, "Russia, England, France come in just wonderful. Will never buy any other receiver but a SCOTT." . . . And tropic reception is "tough."

SEND COUPON AT ONCE FOR COMPLETE INFORMATION

The SCOTT ALL-WAVE Deluxe gives perfected performance on all wave bands from 15 to 550 meters. It incorporates every worthwhile development of radio engineering, including Automatic Volume Control, Visual Tuning, Static Suppressor, etc. For all technical data, price quotations, and performance PROOFS, send coupon.



E. H. SCOTT RADIO LABORATORIES, INC.
4450 Ravenswood Ave., Dept. C-73, Chicago, Ill.
Send me at once, without obligation, complete information regarding the SCOTT ALL-WAVE Deluxe, including performance PROOFS, technical data, etc.

Name

Address

City State



Broadcasting Stations employ trained men continually for jobs paying up to \$5,000 a year.



Police Departments are finding Radio a great aid in their work. Many good jobs have been made in this new field.

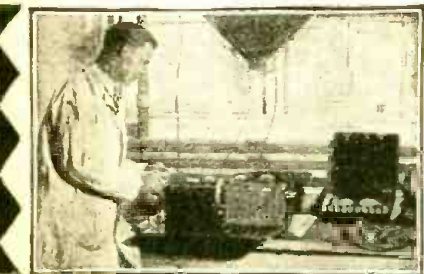

Spare-time set servicing pays many N.R.I. men \$200 to \$1,000 a year. Full-time men make as much as \$65, \$75, \$100 a week.



Talking Movies—an invention made possible by Radio—employs many well trained radio men for jobs paying \$75 to \$200 a week.



Television—the coming field of many great opportunities—is covered by my course.

I WILL TRAIN YOU AT HOME

Many Make \$50 to \$100 a Week in Radio -- the Field With a Future

My book, "Rich Rewards in Radio," gives you full information on the opportunities in Radio and explains how I can train you quickly to become a Radio Expert through my practical Home-Study training. It is free. Clip and mail the coupon NOW. Radio's amazing growth has made hundreds of fine jobs which pay \$50, \$60, \$75 and \$100 a week. Many of these jobs may quickly lead to salaries as high as \$125, \$150 and \$200 a week.

Radio—the Field With a Future

Ever so often a new business is started in this country. You have seen how the men and young men who got into the automobile, motion picture and other industries when they were started had the first chance at the big jobs—the \$5,000, \$10,000 and \$15,000 a year jobs. Radio offers the same chance that made men rich in those businesses. It has already made many men independent and will make many more wealthy in the future. You will be kicking yourself if you pass up this once-in-a-lifetime opportunity for financial independence.

Many Radio Experts Make \$50 to \$100 a Week

In the short space of a few years 300,000 Radio jobs have been created, and thousands more will be made by its future development. Men with the right training—the kind of training I will give you in the N.R.I. Course—have stepped into Radio at 2 and 3 times their former salaries. Experienced service men as well as beginners praise N.R.I. training for what it has done for them.

Many Make \$5, \$10, \$15 a Week Extra In Spare Time Almost At Once

My Course is world-famous as the one "that pays for itself." The day you enroll I send you instructions, which you should master quickly, for doing 28 Radio jobs common in most every neighborhood. Throughout your Course I will show you how to do other repair and service jobs on the side for extra money. I will not only show you how to do the jobs but how to get them. I'll give you the plans and ideas that have made \$200 to \$1,000 a year for N.R.I. men in their spare time. G. W. Page, 110 Raleigh Apts., Nashville, Tenn., writes: "I made \$935 in my spare time while taking your Course." My book, "Rich Rewards in Radio," gives many letters from students who earned four, five and six times their tuition fees before they graduated.

Get Ready Now for Jobs Like These

Broadcasting stations use engineers, operators, station managers and pay up to \$5,000 a year. Radio manufacturers employ testers, inspectors, foremen, engineers, service men, buyers and managers for jobs paying up to \$6,000 a year. Radio dealers and jobbers (there are over 35,000) employ service men, salesmen, buyers, managers and pay up to \$100 a week. Talking pictures pay as much as \$75 to \$200 a week to men with Radio training. There are hundreds of opportunities for you to have a spare-time or full-time Radio business of your own—to be your own boss. I'll show you how to start your own business with practically no capital—how to do it on money made in spare time while learning. My book tells you of other opportunities. Be sure to get it at once. Just clip and mail the coupon.

I HAVE STARTED MANY IN RADIO AT 2 AND 3 TIMES



**\$400.00
Each
Month**



**\$800.00
In Spare
Time**



**Chief
Engineer
Station WOS**

"I spent fifteen years as traveling salesman and was making good money but could see the opportunities in Radio. Believe me, I am not sorry, for I have made more money than ever before. I have made more than \$400 each month and it really was your course that brought me to this. I can't say too much for N.R.I."—J. G. Dahlstead, Radio Sta. KYA, San Francisco, Cal.

"Money could not pay for what I got out of your course. I did not know a single thing about Radio before I enrolled, but I have made \$800 in my spare time, although my work keeps me away from home from 6:00 A.M. to 7:00 P.M. Every word I ever read about your course I have found true."—Milton I. Leiby, Jr., Tipton, Pennsylvania.

"I have a nice position and am getting a good salary as Chief Engineer of Radio Station WOS. Before entering Radio, my salary was barely \$1,000.00 a year. It is now \$2,400.00 a year. Before entering Radio, my work was, more or less, a drudgery—it is now a pleasure. All of this is the result of the N.R.I. training and study. You got me my first important position."—H. H. Lance, Radio Station WOS, Jefferson City, Missouri.

TO BE A RADIO EXPERT



Act Now --- Mail Coupon Below for Free Book of Facts and Proof

You Can Learn at Home in Your Spare Time to be a Radio Expert

Hold your job. There is no need for you to leave home. I will train you quickly and inexpensively during your spare time. You don't have to be a high school or college graduate. My Course is written in a clear, interesting style that most anyone can grasp. I give you practical experience under my 50-50 method of training—one-half from lesson books and one-half from practical experiments with equipment given without extra charge. This unique and unequalled method has been called one of the greatest developments in correspondence Radio training. N.R.I. pioneered and developed it. It makes learning at home easy, fascinating, practical.

Learn the Secrets of Short Wave, Television, Talking Pictures, Set Servicing, Broadcasting

I'll give you more training than you need to get a job—I'll give you your choice, and not charge you extra either, of my Advanced Courses on these subjects—(1) Television, (2) Set Servicing and Merchandising, (3) Sound Pictures and Public Address Systems, (4) Broadcasting, Commercial and Ship Radio Stations, (5) Aircraft Radio. Advanced specialized training like this gives you a decided advantage.

Your Money Back if You are Not Satisfied

I will give you an agreement in writing, legal and binding upon this Institute, to refund every penny of your money upon completing my Course if you are not satisfied with my Lessons and Instruction Service. The resources of the National Radio Institute, Pioneer and World's Largest Home-Study Radio School, stand behind this agreement.

Find Out What Radio Offers. Get My Book

One copy of my valuable 64-page book, "Rich Rewards in Radio," is free to any resident of the U. S. and Canada over 15 years old. It has started hundreds of men and young men on the road to better jobs and a bright future. It has shown hundreds of men who were in blind alley jobs, how to get into easier, more fascinating, better paying work. It tells you where the good Radio jobs are, what they pay, how you can quickly and easily fit yourself to be a Radio Expert. The Coupon will bring you a copy free. Send it at once. Your request does not obligate you in any way. Mail coupon in envelope or paste on post card. ACT NOW.

J. E. SMITH, President
Dept. 3GX, National Radio Institute
Washington, D. C.

FORMER PAY



Experienced Radio Man Praises N. R. I. Course

"Before taking your course, I had worked at Radio for over seven years, doing quite a bit of servicing, but I realized that I was in need of better training. From the first lesson on I began to understand points that had had me wondering. The course has taught me what I could not have learned otherwise and I would not take many times the price it has cost me, for the knowledge I have gained. In a period of nine months, I have made at least \$3,500."—C. J. Stegner, 28 So. Sandusky St., Delaware, Ohio.



Special FREE Offer



Act now and receive in addition to my big free book, "Rich Rewards in Radio," this Service Manual on D. C., A. C. and Battery Operated sets. Only my students could have this book in the past. Now readers of this magazine who mail the coupon will receive it free. Overcoming hum noises of all kinds, fading signals, broad tuning, howls and oscillations, poor distance reception, distorted or muffled signals, poor Audio and Radio Frequency amplification and other vital service information is contained in it. Get a free copy by mailing the coupon below. ACT NOW.

SPECIAL Radio Equipment for Broad Practical Experience Given Without Extra Charge



My Course is not all theory. I'll show you how to use my special Radio equipment for conducting experiments and building circuits which illustrate important principles used in such well-known sets as Westinghouse, General Electric, Philco, R. C. A., Victor, Majestic and others. You work out with your own hands many of the things you read in our lesson books. This 50-50 method of training makes learning at home easy, interesting, fascinating, intensely practical.

Clip and mail NOW for FREE INFORMATION

J. E. SMITH, President,
National Radio Institute, Dept. 3GX,
Washington, D. C.

Dear Mr. Smith: Please send me your sample lesson "Trouble Shooting in D. C., A. C. and Battery Sets" and your book, "Rich Rewards in Radio," which points out the opportunities for spare-time and full time jobs in Radio and your famous 50-50 method of training men to become Radio Experts through home study. I understand that this places me under no obligation. (Please print plainly).

Name..... Age.....

Address

City..... State.....

"M"

This

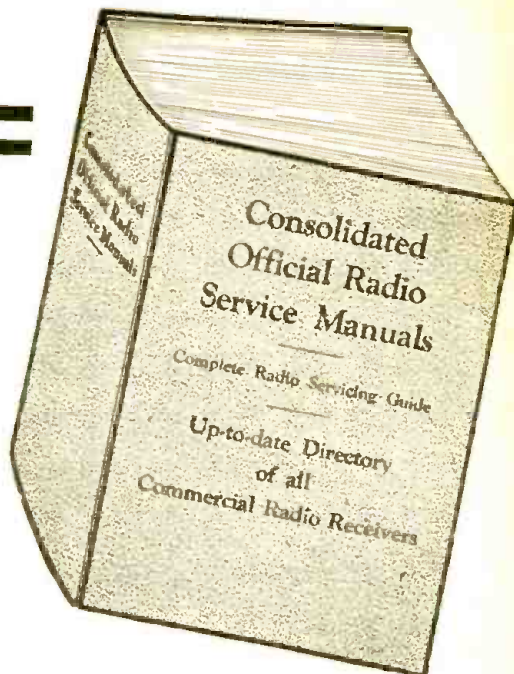

Radio's GREATEST Servicing Book

The Most Complete Directory of Radio Circuit Diagrams published!

**In ONE VOLUME of over 2,300 Pages
Extra Heavy Cover—Looseleaf Bound**

Buy this Big Volume on our *New* **DEFERRED PAYMENT PLAN**

Here are two of the most surprising announcements that we have ever made to the radio trade and we know that it is such good news that every radio man will be greatly enthused.

FIRST—that the three editions of the OFFICIAL RADIO SERVICE MANUALS have now been combined into one big volume of over 2,300 pages.

SECOND—that this new single volume of consolidated radio circuit diagrams and complete radio servicing course can be bought on a deferred payment plan—and at a big saving.

It is needless to say how valuable the OFFICIAL RADIO SERVICE MANUALS have been to members in every branch of the Radio Industry, and how many thousands of each edition have been sold to manufacturers, jobbers, dealers, Service Men and experimenters. But we must emphasize this one fact: Service Men now realize that they are tremendously handicapped without the full set of Gernsback Manuals. So much so, that those who have purchased only one or two volumes, are NOW ORDERING THE MISSING BOOKS. They want their files to be complete.

The complete book gives you a volume of over 2,300 pages with over 5,500 diagrams, charts and photos. There are absolutely no pages or illustrations or diagrams duplicated. There is no radio book published today which is so modern, up-to-the-minute, and which contains so much useful information as is to be found in this single volume. It is a book that will outlast any other radio book in print. Look carefully at the illustration of the complete edition on the top of page. It measures 9" wide, 12" long, 4½" thick.

Included in this volume is a complete radio servicing course. This course covers every step needed to learn the servicing business . . . from starting in business . . . materials needed . . . and how to go about servicing receivers and repairing other radio equipment. This course in itself, is actually worth the price of the entire book.

Our new plan now enables every radio man to get this single volume—a Complete Directory of all Circuit Diagrams, of over 2,300 pages, on deferred payments. You can order this book immediately—get it in a few days, and use it while you are doing servicing work. You can make the first few calls pay for the entire cost of the book.

For you to get this book is quite simple and it is sent to you as soon as your order is received. You pay for it in small monthly amounts which can be taken from your earnings. If you were to buy the three volumes separately, the total cost would be \$17.00, including the supplements.

Now you can get the
1931 OFFICIAL RADIO SERVICE MANUAL, with Supplements,
1932 OFFICIAL RADIO SERVICE MANUAL, with Supplements,
and the 1933 OFFICIAL RADIO SERVICE MANUAL Complete
at a big saving.

THE SPECIAL NEW PRICE FOR ALL THREE MANUALS, WITH SUPPLEMENTS, IN ONE VOLUME, WITH HEAVY BINDER IS ONLY

\$14.00

You buy this book this way—
Send \$3.00 with order—
Pay \$5.00 to Express Company upon receipt of book.
Send \$3.00 thirty days after receipt of book.
Send \$3.00 sixty days after receipt of book.
Total \$14.00.

IF THE ENTIRE AMOUNT IS SENT WITH YOUR ORDER, WE WILL ALLOW YOU A 10% DISCOUNT. THIS CAN BE DEDUCTED FROM YOUR REMITTANCE.

IMMEDIATE SHIPMENT

Mail Coupon Today!

GERNSBACK PUBLICATIONS, Inc.,
96-98 Park Place, New York, N. Y.

Gentlemen:

In accordance with your Special Offer, I enclose herewith \$3.00 as first payment toward the One-Volume Radio Manual. Please forward it to me promptly. Upon receipt of the book, I shall pay express company \$5.00. Thirty days later I shall send you \$3.00, and sixty days after receipt of book, I shall send you my last payment of \$3.00. If you want to take advantage of the Special Discount of 10%, remit only \$12.60 with this coupon.

Name _____

Address _____

City _____ State _____

RC-733

OVER 2,300 Pages 5,500 Illustrations

THIS IS THE GREATEST SINGLE VOLUME RADIO BOOK IN PRINT TODAY

GERNSBACK PUBLICATIONS, Inc.

96-98 Park Place

New York, N. Y.



"Takes the Resistance Out of Radio"

Editorial Offices: 96-98 Park Place, New York, N. Y.

HUGO GERNSBACK, Editor

Vol. V, No. 1, July, 1933

SUMMER RADIO

An Editorial by HUGO GERNSBACK

THIS is the time of the year when, judging by former precedents, radio generally sinks to its lowest level, at least, so far as the business end of the industry is concerned. The old "saw" that there is no radio business worth speaking of in midsummer still has its followers. Yet, many large volumes could be published in direct refutation of these so-called facts.

It is true that, as a rule, during the past few years the sales of radio sets have always fallen off in the summer. That is true, however, only of radio sets and not of other radio merchandise, which is becoming more diversified every day. It is also true, that, where five years ago people did not listen in on their radio sets in the summer time, they are listening in now, for the simple reason that modern sets, being more powerful, easily over-ride the static, and, therefore, make summer reception practically as perfect as winter reception, except during the height of thunderstorms.

So far as Service Men and others who wish to make money out of radio this summer are concerned, the woods are literally full of opportunities if you only look for them.

Public address systems and amplifiers are still in their infancy, and the surface has not yet been scratched.

A few weeks ago the Court of General Sessions, the oldest court in New York City, became more modern than any other court in New York by installing a public-address system to carry the voices of witnesses to the jury boxes. Jurors had always complained that they were unable to hear the testimony, so that the judge interested a friend, who is an official of a large radio corporation, and the amplifier installation was made. If it is successful, all New York City courts will no doubt follow suit, and it won't be long before every large court in the United States will be thus equipped with public-address and loudspeaker systems. Here is another marvelous amplifier outlet, and the wide-awake Service Man and dealer should know what use to make of this information.

In all our cities, both large and small, we have seen portable public-address systems invading the sidewalk. This invasion is particularly true of some of the large drugstores, where demonstrators are no longer "voiceless," as they have been for generations. Nowadays, the demonstrator sits behind the window with a microphone in front of him, and hanging outside, well over the heads of the passersby, is a portable amplifier which projects his voice to the passing populace.

The novelty, alone, causes many people to stop and listen while they watch the demonstrator. The demonstrators, of course, do not build these amplifiers themselves—they buy them somewhere, or have them built to their specifications. There seems to be a good market for this type of amplifier, and its use is increasing by leaps and bounds.

The portable public-address system will be in use in increasing quantities this summer at all resorts; most con-

cessionaires, who have stands of some sort, have use for a public address amplifier, because they can make their voice heard on the sidewalk, in front of their stands, which they could not do as efficiently otherwise. It is the same with hotels, large dining rooms, in the country and at the seaside, where, because of the economic condition of the country, it is not possible for the smaller hotels or restaurants to hire even a mediocre orchestra. By means of a public address system, music can be played all over the hotel, and excellent music can be furnished by means of electrical transcription. Indeed, a portable public address system is now made which combines an electric phonograph and pickup working on either A.C. or D.C. The whole system weighs less than 50 lbs. and can easily be carried.

On the smaller inland lakes, boats can be readily equipped with public-address systems and commercial announcements can be made for the merchants and hotels of the resort, and usually enough advertising of this sort can be picked up to make it worthwhile to run the boat all summer. The restaurants and general stores usually patronize this sort of advertising because it gets results for them.

Then, of course, millions of dollars will be spent this coming summer in modernizing obsolete sets by using the avalanche of new tubes which have recently been brought out. These tubes are now on the market, and some of the tubes lend themselves admirably to modernizing of old receivers and giving them such power as their owners never dreamed of. Much modernizing of this type can be done without extensive re-wiring of the sets, but merely by using adapters or making minor changes in the wiring.

Many country hotels of the resort type will also find increasing use this year for the small "cigarbox" type of radio set. These sets are low in price, and perform well. They are easily transported, require no aerial installation, and are ideal for camp and bungalow use too. Every Service Man this summer should carry with him a demonstration sample of one of these sets, and if the demonstration is made on the spot—which is easy to do, as most up-to-date camps and bungalows are wired for electricity—immediate sales should follow. These sales should be quite good, because the demand for a low-priced radio set for camp and bungalow always was good in the past, and would undoubtedly have been better if the prices had been lower. This year, no such obstacle exists, and the prices are no doubt lower than they will be for many years to come. Prices now are definitely on the upgrade, and it does not take much salesmanship to convince a prospect that never again will he be able to buy a good radio set at the figure he can buy it at now.

Radio this summer can be made quite good *if only you go after the business*, and use a little imagination. There are still excellent opportunities, and those who follow them up will find that radio is not dead in the summer.

HOW TO BUILD THE NEW "TREASURE" FINDER

After ten years of research, the author has built and used the "Treasure" Finder described below. The fundamental principle of operation is well known, and is the basis for many measurements. If you are interested, build it now!

E. FRANKLIN SARVER



The device in the hands of the author. Note the distance between the ground and the loop.

GOLD, in small deposits, is exceedingly difficult to locate. Fortune tellers, doodlebug operators, and other fakers continue to fleece the public and reap a harvest from unfortunate persons who are willing to spend the last cent they possess in an effort to locate buried treasure.

Fortune tellers can prove none of their ridiculous claims, and, therefore, should be discredited and shunned by sane people. Doodlebug operators using plumb bobs, Spanish dip needles, and other such devices, are either out and out swindlers or fanatics who have lost their reason. Then, there is another class of investigators who have constructed electric inductance balances that will actually locate metals

buried a few inches underground. These men, for the most part, greatly exaggerate the power of their equipment; sometimes selling a five-dollar piece of cheaply constructed apparatus for as much as two-hundred dollars. Some of them won't sell the equipment, but charge lucrative wages for a day's work with the device.

Cold Facts

Strip gold of its currency value and consider it, for a few minutes, for just what it is: an ordinary piece of metal; a substance which, scientifically, is one of the "deadest" of metals. A piece of silver or copper has a high electrical conductivity; gold is not as good, in comparison. A piece of iron can be magnetized; gold is non-mag-

netic. Several other metals can produce electric currents by galvanic action; gold does not. Most metals react violently with acids; gold reacts with only two. A piece of iron left to nature will slowly change its form and unite with other elements of nature—it will rust; gold is too dead to rust. Since gold attracts nothing, repels nothing, and is only a fair conductor of electricity, it is therefore difficult to locate when buried. The only method I have been able to discover, after ten years of careful research is to set up a high-frequency electromagnetic field of considerable power, keeping the electric field strength at a minimum, and then determining the distortion of the magnetic field pattern by metal objects which are within this field.

Theory of Operation

The device to be described consists essentially of two radio-frequency oscillators. One of these has a fixed frequency of oscillation, and we shall call this the fixed oscillator, or "monitor" (see Fig. 1); the other oscillator is variable, its frequency being determined by varying characteristics of the inductance in its oscillating circuit. This latter we shall call the "floating oscillator." (See Fig. 1.)

The monitoring and floating oscillators have their grid circuits so coupled that when they are oscillating at different frequencies, a third frequency is produced within the audio spectrum in much the same manner that an I. F. is produced in a super-

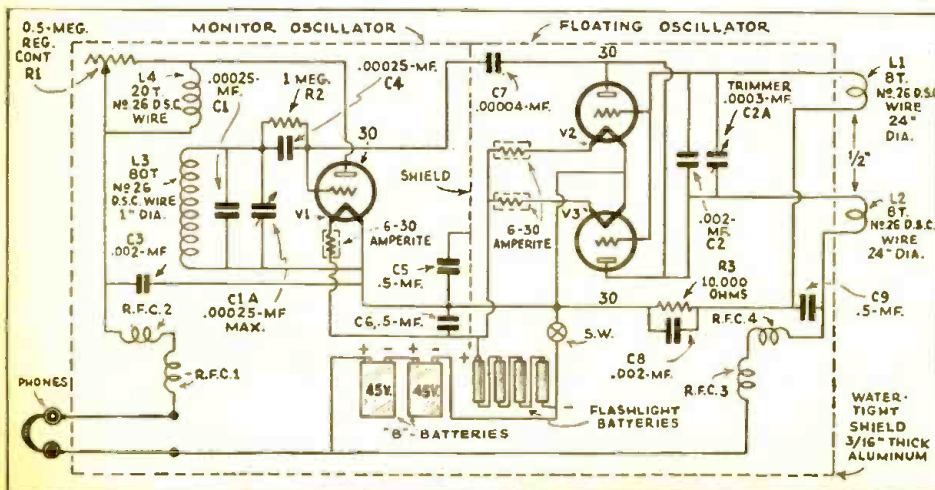

Fig. 1
Schematic circuit of the "Treasure" Finder. See the List of Parts.

FEATURES

- (1) Uses a basic circuit—no tricky connections that usually confuse builders.
- (2) Will locate any substance capable of generating eddy currents.
- (3) It will locate substances at depths depending upon the size of the locator coils. If a coil two feet in diameter is used, the system will locate metals at a distance of ten times two feet, or twenty feet.
- (4) The parts used in its construction are obtainable at almost any radio parts supply house

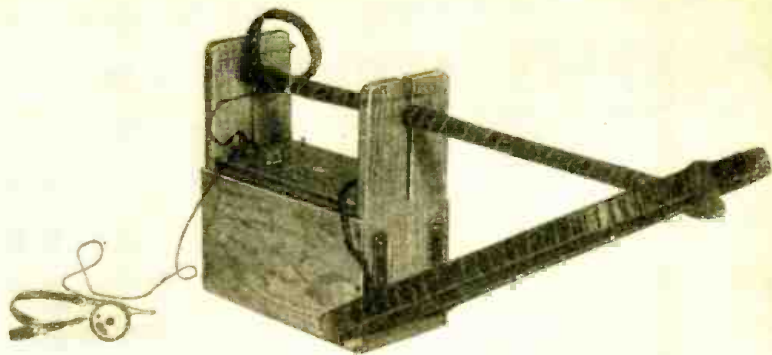

Fig. A
Photograph of the "Treasure" Finder completely assembled.

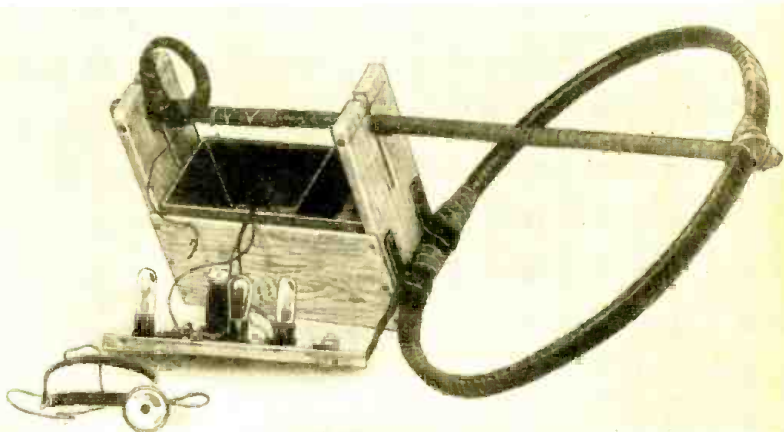

Fig. B
Photograph of the "Treasure" Finder with the lid removed.

heterodyne. With the exception of the coils of the floating oscillator, the two oscillators are completely shielded. The high-potential wires are very carefully choked and bypassed so that all high frequency circuits are strictly localized; this is of vital importance to the successful operation of the instrument.

In operation, there is a high frequency electromagnetic field of force set up by the inductance coils, L1 and L2 of Fig. 1. When this field of force strikes an electrical conductor—any metallic object—eddy currents are set up in the metallic object of such polarity that they repel the electromagnetic field of the floating oscillator, thus changing the electrical characteristics of the inductances L1-L2 to the extent that the natural period of the floating oscillator circuit is altered. The monitoring oscillator, however, continues to oscillate at its fixed frequency, and, consequently, the frequency of the beat note (difference between the two frequencies) being reproduced in the phones is changed. Unfortunately, there is another variable in the floating oscillator circuit which will cause a change of frequency: the electrostatic field, which is varied by capacity change. This electrostatic variable must be kept at the lowest possible value because the electrostatic field at the frequency we use does not penetrate the earth but plays on the surface, making the earth one plate of a variable condenser and the coil L1-L2 the other plate, so that any change of position of the coil L1-L2 will cause a change in the audio beat

note, making the device unstable and unusable. This undesirable effect is minimized by carefully choking and shielding. It will be noticed that there is an electrostatic shield around L1-L2 (see Fig. 2). At first thought it would seem that this shield might absorb a great deal of energy. It is, however, constructed of a piece of copper screen wire, and does not make a complete loop: the ends of the shield are separated by a distance of one inch, the open end being placed opposite the cabinet; the wire grounding this shield to the cabinet is soldered to the shield and cabinet at the nearest points. This coil shield greatly reduces the electrostatic field, but does not materially reduce the electromagnetic field. Further reduction of the electrostatic field is accomplished by grounding the copper box to the body of the operator by a bare copper wire soldered to the box and wrapped around the handle in such a manner that the operator's hand is always in contact with it.

The circuit is comparatively simple, but must be very carefully constructed with precision parts, and all wires must be carefully placed and tied firmly in position using paraffine impregnated twine.

It will be noticed by a study of the values of the component parts of the floating oscillator circuit that the frequency of the floating oscillator is comparatively low. I have found that higher frequencies extend to greater distances, but that the earth, particularly if it is wet, will reflect so much energy that the advantage gained

is more than offset by the losses in the soil; and further, if the frequency is too high, the earth will act as a piece of metal, with the result that erroneous results are constantly being obtained. Another important point is to keep the frequencies of the two oscillators widely separated so that they will not be inclined to drift into step and produce zero beat.

Using the Instrument

In adjusting the instrument, you will find that as the trimmer condenser on the monitor is varied, a beat note will be heard in the phones. Increase the trimmer capacity until zero beat is reached; then increase it just a little more until a beat note is heard at nearly the lowest audio frequency. Then adjust the regeneration control until the monitor just barely keeps oscillating. At this point the instrument is most sensitive. *If the instrument has been carefully constructed, it should produce a noticeable change of pitch in the phones when a piece of copper, equal in diameter to that of the field coil L1-L2 is at a distance of ten times the diameter of the coil.* In other words, if you are using a two foot coil, as shown in Fig. 2, you should be able to determine the presence of a piece of copper two feet in diameter at a distance of twenty feet.

Much, however, depends upon the operator, his familiarity with the operation of the instrument, and the sensitivity of his ear to variations in pitch. By experimenting, you will find that by changing the adjustment of the trimmer condenser on the monitor, you

TREASURE FINDERS

For three years RADIO-CRAFT has run descriptions of metal locators called "Treasure" Finders. The term "Treasure" Finder is not completely descriptive of the function of these devices. The apparatus described in this and previous articles on the subject may be used just as successfully for the location of sewer pipes as for the location of gold. You may explore a certain bit of territory for hours—or even days or weeks—and finally locate a shovel. We wish to emphasize this point merely because hundreds have written in demanding to know how the device may sift scrap metal from gold. Any metal locating device is incapable of sifting—it can only determine the presence of substances which are large enough and good enough conductors of electricity to work the apparatus.

can cause the audio frequency to either increase or decrease when metal is present in the floating field, depending on which side of zero beat the note is brought in. I find that much more satisfactory results are obtained by adjusting the trimmer, C1A, so that the pitch *increases* when metal is brought into the field. Be sure to adjust the floating-oscillator trimmer, C2A, so that a change in pitch caused by metal entering the field of the floating coil will be in the opposite direction to the change in pitch caused by a capacity change when the hand is brought near the field coil. Operation in this manner makes it possible to swing the coil slowly from side to side over the ground and disregard frequency changes going slightly *down* the musical scale, because you will know they are caused by ground capacity; a rising pitch will always mean the presence of metal directly under the field coil.

Construction Details

With reference to Fig. 1, coils L1 and L2 each consist of 8 turns of No. 26 D.S.C. wire, 24 inches in diameter.

L1 is separated from L2 by a distance of $\frac{1}{2}$ inch. The physical layout of this coil is given as previously stated in Fig. 2.

The coil L3 consists of 80 turns of No. 26 D.S.C. wire on a form one-inch in diameter. Separated with a small disc from L3—about $\frac{1}{4}$ inch—is L4, which consists of 20 turns of No. 26 D.S.C. wire. All coils are close wound. Do not use varnish or shellac on the coils; use a clear lacquer to hold the turns in place after they have been wound. With reference to the coils L1 and L2, carefully tape them, after they have been wound, with one layer of strong linen tape, treat with lacquer, and then put the screen shield into place around the outside of the coil; now cover it with a second layer of linen tape, tightly wound, and then lacquer the entire assembly. These coils may be made from seasoned hard wood: a glued type, all wood bicycle rim makes an excellent form. The construction details of the assembly are illustrated in Figs. A, B, and 2. All dimensions are labeled thereon, and you should have little difficulty in constructing same.

List of Parts

- Four coils, as described, L1, L2, L3, L4;
- One Aerovox fixed mica condenser, .00025-mf.; C1;
- Two variable compression trimmer condensers, 220 mmf., C1A, C2A;
- Three Aerovox .002-mf. fixed mica condensers, C2, C3, C8;
- One Aerovox fixed condenser, 250 mmf., C4;
- Three Aerovox mica condensers, .5-mf., C5, C6, C9;
- One Aerovox, 40 mmf. fixed mica condenser, C7;
- One Electrad, 500,000-ohm rheostat, R1;
- One I.R.C., 1 meg. grid leak, R2;
- One I.R.C., 10,000-ohm resistor, 1 watt, R3;
- Four Trutest, type H10102, 5.5 millihenry chokes, RFC1, RFC2, RFC3, RFC4;
- Three four-prong sockets;
- Three Amperites, type 6-30;
- Four flashlight cells;
- Two 45-volt portable "B" batteries;
- One pair telephone receivers;
- Three type 30 tubes;
- One case, as per construction details.

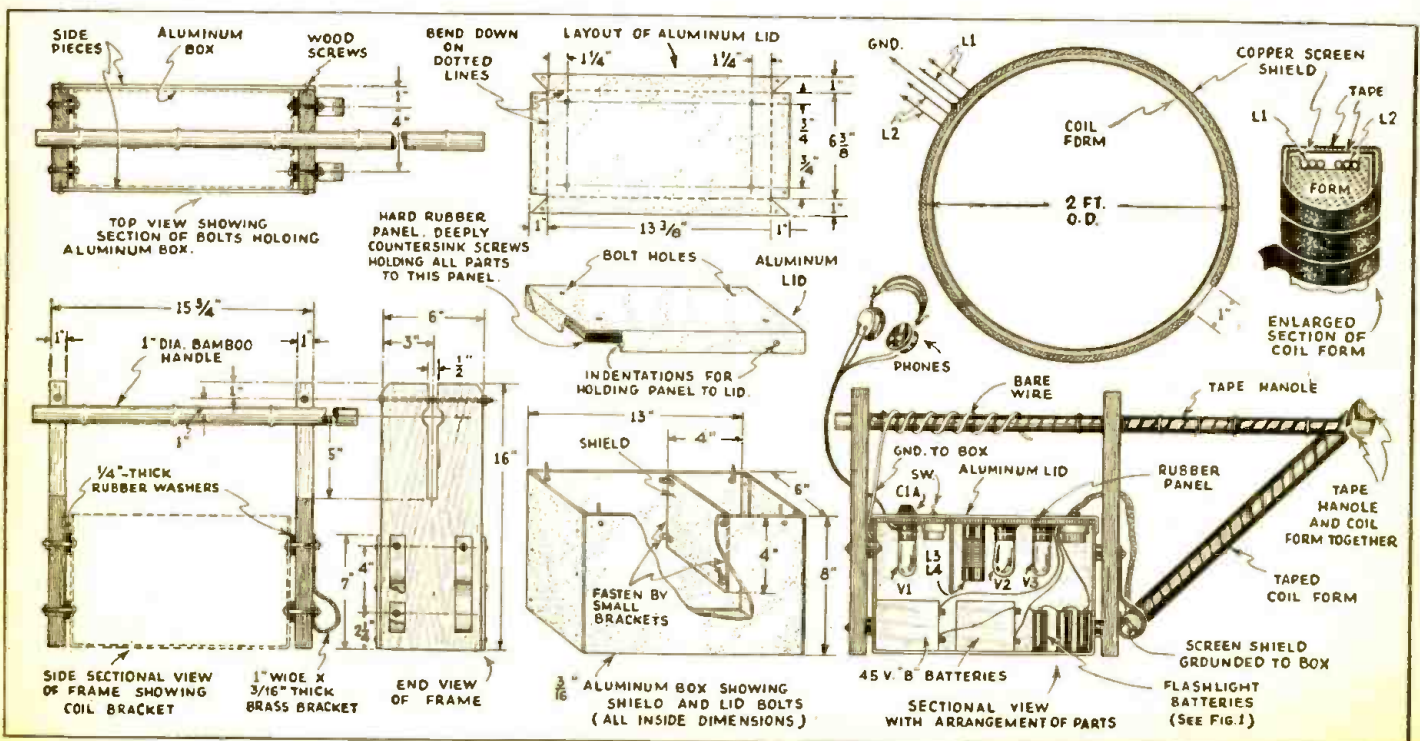

Fig. 2

Complete mechanical drawings of the device. It is not necessary that constructors follow exactly the drawings in order to secure good results.

THE N. R. I.--PHILCO SET TESTER

An unusually complete and versatile "all-purpose" set tester that meets all the requirements of modern service work has been developed by engineers of the National Radio Institute and the Philco Radio & Television Corporation. This excellent instrument permits the isolation of the defective circuit and the detection of the defective part, and the use of point-to-point voltage or resistance measurements, regardless of the type of receiver. The use of complicated and troublesome adapter plugs has been entirely avoided.

The carrying case measures 11 3/8 x 7 1/4 x 8 1/2 inches, and includes all of the following:

(1) A shielded signal generator covering all frequency ranges from 105 to 2,000 kilocycles; direct reading dial, calibrated in kc.; shielded lead for connection to all types of radio sets; batteries self-contained, for testing A.C., D.C., battery, and automobile receivers.

(2) Rectifier type output meter with five ranges; universal output adapters with 36-inch leads for making connections to all types of output tubes.

(3) A.C. voltmeter: accurate A.C. voltage readings are obtained through the use of different scales for low and high range readings. Calibrated to 0-10, 0-20, 0-100, 0-200 and 0-1,000 volts.

(4) D.C. voltmeter, with 0-10, 0-20, 0-100, 0-200 and 0-1,000 volt scales. D.C. scale is black, A.C. scale is red, for quick identification.

(5) D.C. milliammeter, ranges 0-5-, 0-1, and 0-100 ma.

(6) Ohmmeter, 0-1,500, 0-150,000, and 0-1,500,000 ohms. Accurate readings as low as 2 ohms.

(7) Tube tester, providing accurate performance test using signal generator and output meter.

(8) Capacity meter. .01- to 2 mf. range, using 60 cycles, A.C.

The basic meter is a 0-5-ma. jewel pivoted milliammeter. When used as an A.C. or D.C. voltmeter, it has a sensitivity of approximately 2,000 ohms per volt. A simple system of tip jacks permits quick selection of any desired scale range.

The complete instrument weighs only 12 pounds. The case is strongly constructed and will stand the abuse to which service equipment in general is subjected.



Panel view of the N. R. I.—Philco set tester described here.

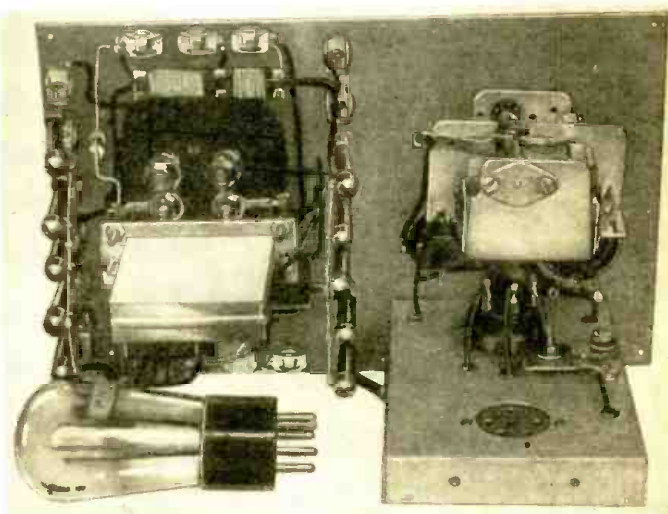

Inside view of the tester. A shield, not shown, surrounds the oscillator section.

POSTAL "UNIVERSAL" AUTO KIT SET

A UNIVERSAL five-tube midget superheterodyne that can be used on either alternating or direct current at 110 volts, or on six volts D.C. for car operation, has been brought out by the Postal Radio Corporation. For automobile service the set may be mounted on the car's instrument board and controlled directly by its regular knobs, or may be placed on the engine bulkhead and operated by remote control from the steering column through a flexible drive shaft.

For A.C.-D.C. house operation the tube filaments are connected in series; for car operation, they are put in parallel. The first tube is a 6A7, acting as a combined oscillator-first detector. This feeds into a 78 I.F. amplifier, which is followed by a 77 second detector and a type 43 output tube. A 25Z5 rectifier tube is included in the power supply circuit. The intermediate amplifier is tuned to 465 kc.

The receiver is self-contained except for the "B" supply for auto service. Chassis and dynamic loud-speaker

(Continued on page 55)



Here is how the Postal set looks when installed in a car.

LATEST RADIO EQUIPMENT

RESISTOR KIT

A LEADING resistor manufacturer announces a new kit of 1/2-watt resistors placed in a handy box, as illustrated below. There are twenty resistors in all, ranging in values from 50 ohms to 3 megs. The individual values are as follows: 50, 100, 250, 500, 1,000, 1,500, 2,000, 5,000, 10,000, 20,000, 25,000, 50,000, 75,000 ohms, and .1-, .25-, .5-, 1, 1.5, 2, and 3 megohms.

It is interesting to note the change in construction that resistors have undergone in the past few years. Not many years ago all resistors were made in the cartridge type—a grid-leak mounting was necessary to hold the unit in place. Now, the end caps are replaced by pigtails, and the pigtails furnish the sole support for the unit, which is, incidentally, quite sufficient.

The variety of sizes now available is a godsend, too.

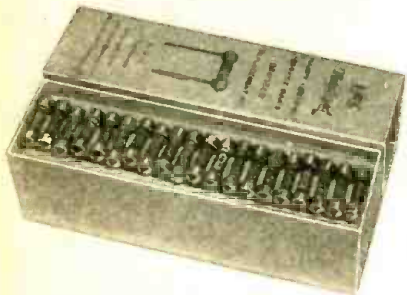

The resistor kit. (101)

INTENSIFIER-SUPPRESSOR

A NEW little device, designed to connect in the antenna circuit of radio receivers, has been produced and is now procurable. The device consists of two rotating concentric tubes coated with copper leaf on the inside; it is manipulated by twirling the two tubes, as shown in the illustration below.

According to the manufacturers, the maximum capacity of the condenser is .001-mf., while the minimum capacity is practically zero.

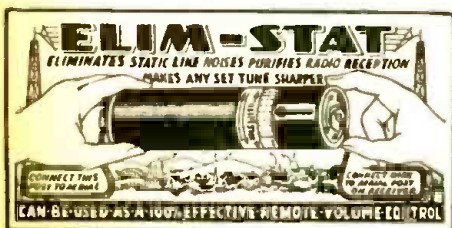

Intensifier-Suppressor. (102)

CONDENSERS

THERE is now generally available a new line of condensers suitable for requirements where the voltages range from 200 to 7,000 volts. A photograph of one type of unit, designed for use in aircraft or portable transmitting service, is illustrated below.

These units, of course, are built in a large variety of sizes between the two limits mentioned.

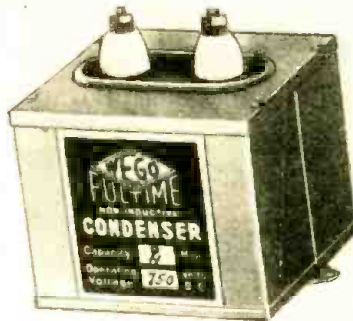

A condenser. (103)

MIDGET DYNAMIC SPEAKER

A WELL-KNOWN manufacturer is now in production on a new midget speaker illustrated below. The unit is but 5 1/2 inches square and 2 1/2 inches deep, including the output transformer. The field coil of the unit shown has a resistance of 3,000 ohms, and its output transformer is designed to feed from a single output tube.

No doubt, the speaker is available for various tubes and circuits.

Only one type is shown below.

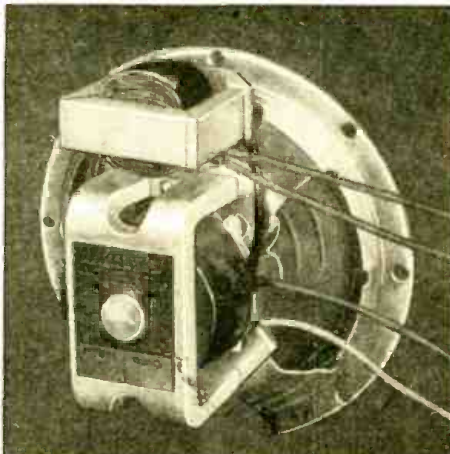

New midget speaker. (104)

NEW METER

IN the instrument field there may now be procured by any one a low cost type 531 D.C. or A.C. meter of the magnetic-vane type suitable for panel mounting. The D.C. type is illustrated below.

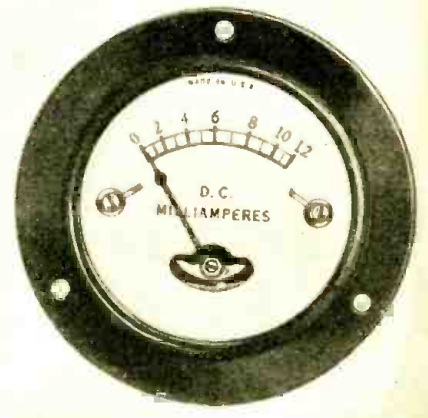

New D. C. meter. (105)

NEW SOCKET

TO meet the variety of uses, there is now a new socket of unique design. In mounting, it is pressed and turned, and the job is finished. No rivets or screws are necessary.



Circular socket and template. (106)

NEW RESISTOR

THE type L unit, designed for multiple mounting on a stud, as shown, is now available. Because they are precision built, these units are especially valuable for decade, bridge, and test apparatus.

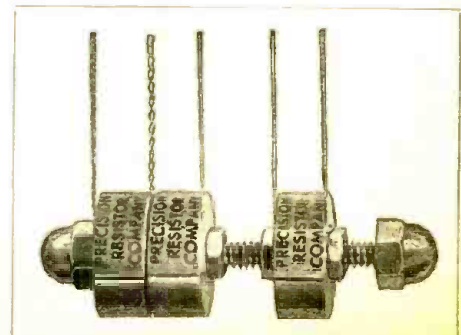

"Multiple" resistors. (107)

Name of manufacturer of any device will be sent on receipt of a self-addressed, stamped envelope. Kindly give (number) in description under picture.

OHMMETER

AN ohmmeter, designed specifically for circuit testing, is marketed by a firm, is now available, and is illustrated below. Known as the Model 402, it is adaptable for use by electricians, Service Men, and mechanics. In two ranges, it is capable of measuring resistances from .25-ohm to 2 megohms. The instrument is housed in a black metal case and measures 5½ inches wide, 8½ inches high, and 2½ inches deep. The sensitivity of the meter is 1,000 ohms per volt and is of the d'Arsonval type.



An ohmmeter—nothing else but. (108)

THE AUTONATOR

TAKING no drain from the auto battery, and having no brushes, collector rings, commutator, or wire-wound armature to require service, the Autonator, now manufactured and generally available furnishes 110 volts, 60 cycles A.C. in automobiles, trucks, buses, etc. for the operation of radio sets, and P.A. systems.

It is designed for operation from the fan belt, and provision is made for the regulation of voltage at all speeds. The Autonator is available in six sizes: 50, 100, 150, 250, 350, and 500 watt ratings.

The device is illustrated below. As may be seen, it is completely housed in a strong case and is equipped with the pulley required for driving. It is very easy to mount.



A generator. (110)

A BRIDGOHMMETER

AFTER much research, there has been designed a novel resistance bridge suitable for the measurement of resistance from .1-ohm to 10 megohms. This device is not an ohmmeter—it is a Wheatstone bridge designed for rapid manipulation, so necessary in modern service work. An interesting advantage is that it may be either A.C. or battery operated.

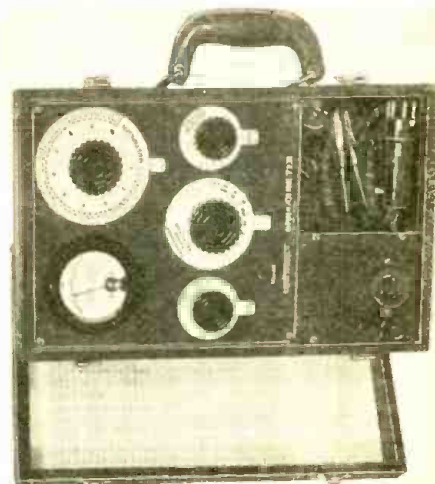

Bridgohmmeter. (111)

TUNING CONDENSER

ALARGE condenser manufacturer now has made available a new "double end" condenser known as the type 516. One rotor may be blocked in any position. They are available in many sizes.

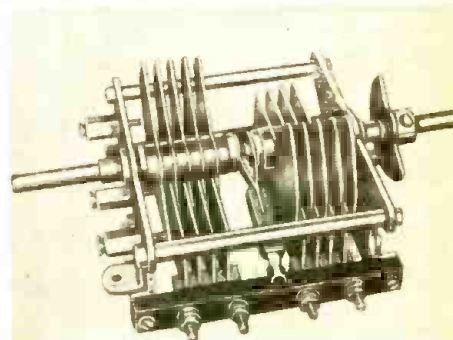

"Double end" condenser. (112)

"RADIO MODULATOR"

ASERVICE Man may avail himself of a very novel device that converts any radio set into a public-address system. The modulator consists essentially of an R.F. oscillator modulated by the Heising system by a microphone or phonograph; the output of this modulator is then connected to the antenna and ground posts of the radio receiver which amplifies and rectifies the modulator's output in the normal manner. Thus, it becomes entirely unnecessary to "revamp" the receiver to use it for P.A. work. Two type 27 tubes are used: one as the oscillator and the

other for the speech amplifier.

In view of the fact that the modulator is grounded and placed in a shielded container, and because the antenna is disconnected from the radio receiver while the modulator is in use, radiation is reduced to practically zero.

An interesting application of this device is its use in demonstration booths in radio stores. The device may be set up by the demonstrator so that its output feeds several sets. The one which reproduces the customer's voice most naturally is the best set.

Thus, the customer sells himself.

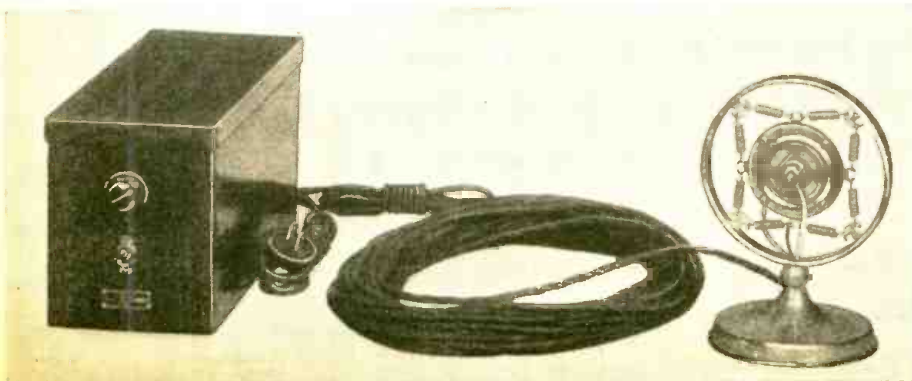

Photograph of the radio modulator. (109)

LAPEL MICROPHONE

ILLUSTRATED below is one of two new types of lapel microphones produced by a large microphone manufacturer. It is light, noiseless, and housed in bakelite.

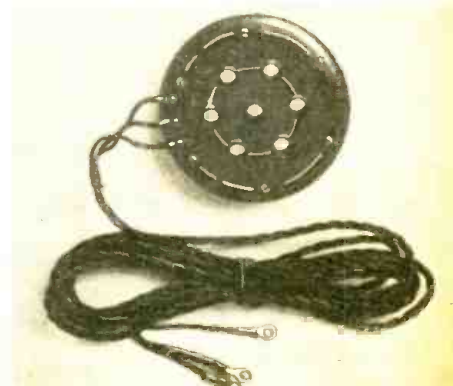

Lapel microphone. (113)

NEW TUBE DATA

Of the several new tubes now available, almost all are designed to replace the oscillator and first-detector in superheterodynes, resulting in increased gain.

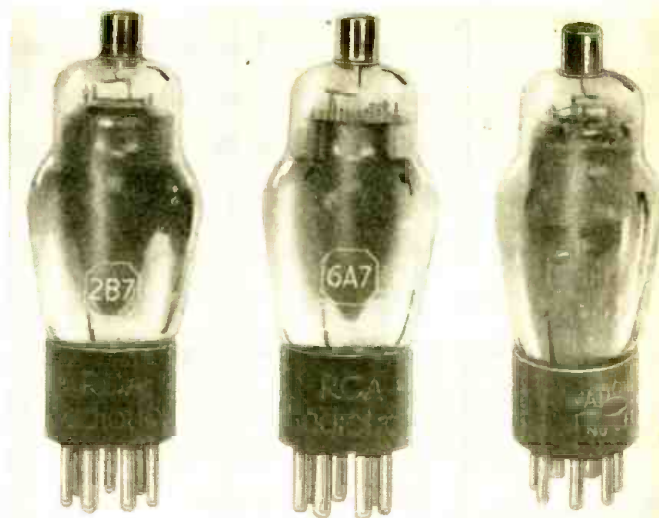

(Data courtesy RCA, Sylvania, Raytheon, and National Union.)

LOUIS MARTIN

RELATIVELY speaking, of the several new contributions to the receiving tube field that have been announced during the past month, only one is radical enough in design to merit detailed consideration. The tubes, however, will be described in alphabetical order for easy reference.

2A6—New Duo-Diode Triode

The Eveready Raytheon Corporation announces a tube almost identical in construction with the type 75 described in the April issue of this magazine. This new tube is known as the 2A6 and differs mainly in the filament rating which is 2.5 volts at .8-ampere. The 75, referred to above, is a 6.3-volt, .3-ampere tube.

The characteristics of this tube follow: plate voltage, 250; grid bias, —2 volts; plate current, 1.2 ma.; amplification factor, 100; plate resistance, 90,000 ohms; mutual conductance, 100 micromhos. As will be noted, the triode section has a high amplification factor equal in value to that of the 75. The socket connections for this tube are shown at A in Fig. 1 and the plate characteristics in Fig. 2.

2A7 and 6A7—Electron-Coupled Converters

These two new tubes are 5-grid, electron-coupled detector-oscillators designed especially to replace the more conventional oscillator and detector tubes in superheterodyne receivers. These tubes are similar in electrical characteristics, except for the filament rating: the 2A7 is rated at 2.5 volts at .8-ampere, and the 6A7, 6.3 volts at .3-ampere. Combining the functions of oscillator and detector into a single tube of the construction illustrated here offers

several advantages: first, the translation gain—intermediate-frequency voltage divided by the R.F. signal voltage—is greater in the 2A7 or 6A7 than when separate tubes are used; second, more complete isolation between the R.F., oscillator and I.F. circuits is secured; and third, the frequency of oscillation of the oscillator is much more stable than in the more conventional arrangements. This latter is due to the fact that the frequency of oscillation is independent of the

load on the oscillator portion of the tube, a characteristic which is common to all electron-coupled oscillators.

It might be well to reconstruct this tube and analyze its action. Fig. 3A shows a heater, a cathode, a grid, and a plate, similar in construction to a 27 tube, with which we are all familiar. In such a tube, we know that the signal is applied between the grid and the cathode, and, furthermore, we know that the positive swings of the signal increase the plate current and the negative swings of the signal decrease the plate current. Instead of making the plate of a solid piece of metal, suppose we construct it of two rods, connected together, as shown in B of Fig. 3. We know, of course, that these small rods will not collect as many electrons as would the solid plate, shown in A, but we do know that this tube will function exactly as that shown at A. Our new tube may now be connected in the conventional oscillator arrangement, as shown at C of Fig. 3. So far, the only change made was in the physical construction of the plate. Suppose, we now put another grid and our old plate inside the tube, as shown at D. Our tube is now divided into two distinct

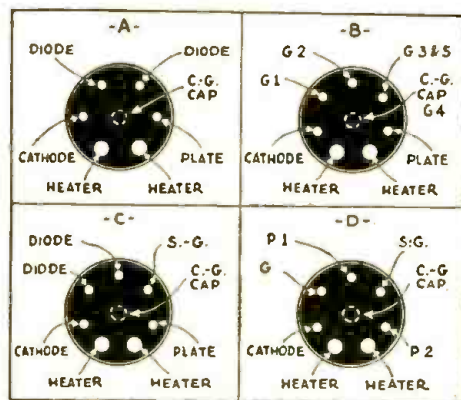

Fig. 1

At A, socket connections of the 2A6; at B, for the 2A7, 6A7; at C, for the 2B7, 6B7; at D, for the 6F7.

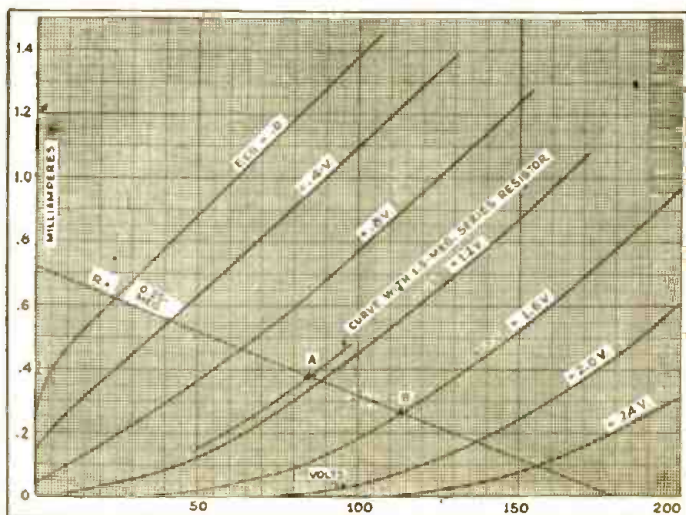

Fig. 2

Plate characteristics for the 2A6; note the load line.

parts: the triode unit shown at C, and another grid and plate. If we connect grid No. 1—shown at E in Fig. 3—to an oscillator circuit, connected as shown in 3C and grid No. 3 to a radio-frequency signal, the final connection will be that shown at E. The two coils, shown to the left in this diagram, are the usual oscillator coils used in the conventional superheterodyne; and the two coils, shown in the center, are the conventional first-detector R.F. coils, while the two coils to the extreme right constitute the first I.F. transformer.

Thus, we see that grid No. 1 is the control grid for the oscillator, while the two rods

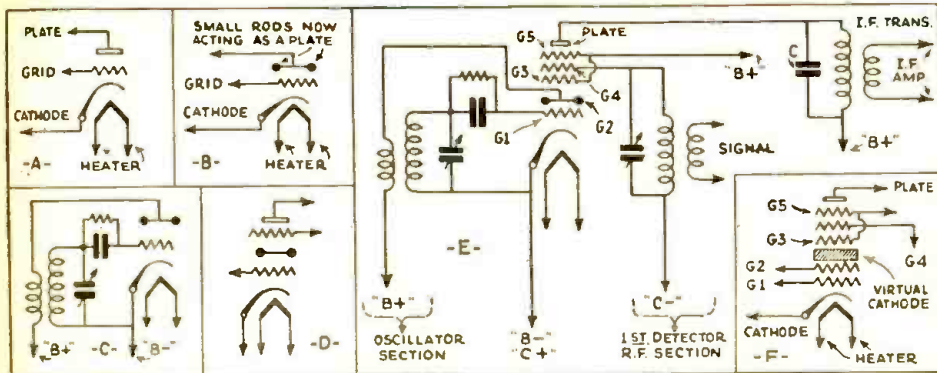

Fig. 3

A series of drawings pictorially showing the construction and operation of the 2A7 and 6A7 tubes.

—called the *anode-grid*—act as the plate of our simple 3-element tube, shown in B. These rods are known as grid No. 2. The third grid which we installed and which we connected to the R.F. coil is known as grid No. 4; grids 3 and 5 merely surround this grid in order to shield it from the plate and from grid No. 2. This shielding results in a high plate resistance, common to all tetrodes, gives a high gain, and also prevents interaction between the signal section of the tube and the oscillator section.

We may now trace out the complete action of the electron-coupled converter. The cathode emits a copious supply of electrons which are attracted mostly by the positive potential of grid 2. In view of the fact that the cathode, grid 1, and grid 2, is producing oscillations, the electron stream passing through the two rods is varied at the frequency of oscillation of this section of the tube. Since grid 3 is interposed between G2 and the plate, those electrons which do pass it are further varied in intensity because of the signal applied to grid 4. Now, grid 4 is biased exactly as an amplifier, and because of the interaction of the signal and the oscillator, only one-half of the signal causes current to flow to the actual plate. In this manner the electron stream to the plate—and hence, the plate current—is varied: first, by the oscillator; and second, by the signal. Consequently, the I.F. produced is equal in frequency to the difference between the oscillator and the signal, and flows through the first I.F. transformer primary.

In connection with this theory, it should be pointed out that enough electrons must exist between grids 2 and 3 so that the plate current may be increased due to the positive parts of the signal even though the oscillator grid may be negative. In other words, that space in the tube between grids 2 and 3 becomes a *virtual cathode* for the signal portion of the tube. This idea is represented by the sketch at F in Fig. 3. The signal grid, G4, is so constructed that it has variable-mu characteristics. This condition enables the tube to be connected in conventional A.V.C. circuits when other A.V.C.-controlled tubes are of the 58 type.

If, in a given circuit, an A.F. os-

cillation is experienced when using this tube, it is probably due to too much feed-back for the values of grid-leak and grid-condensers employed. Under these conditions, the coupling between the oscillator coils should be reduced or the value of the grid-leak lowered. The amount of I.F. obtained from the tube may be controlled by a variable negative voltage on the modulator grid—signal grid—which may be obtained either from a separate supply or from a variable resistor in the cathode circuit. Further consideration on this point will be given later.

The range of control-grid bias required to control the I.F. signal should be governed by the screen grid—G3 and G5—voltage. With 100 volts on the screen grid and -3 volts on the signal grid, the range of bias voltage may be from -3 to about 50. If the screen voltage is below 100 volts, then the maximum variation in signal grid bias must be somewhat less than 50.

Figure 4 shows the variation of mutual conductance with variations in modulator-grid volts. It is seen that the mutual conductance decreases quite uniformly for bias voltages in the neighborhood of 20 volts, which means that the I.F. output varies uniformly with corresponding variations in grid bias. With reference to Fig. 3E it should be mentioned that the value of C should be greater than 50 mmf., in order that undesirably high voltages are not built up in the plate circuit; if such voltages do build up, degenerative action will take place, resulting in decreased efficiency.

An interesting curve is that shown

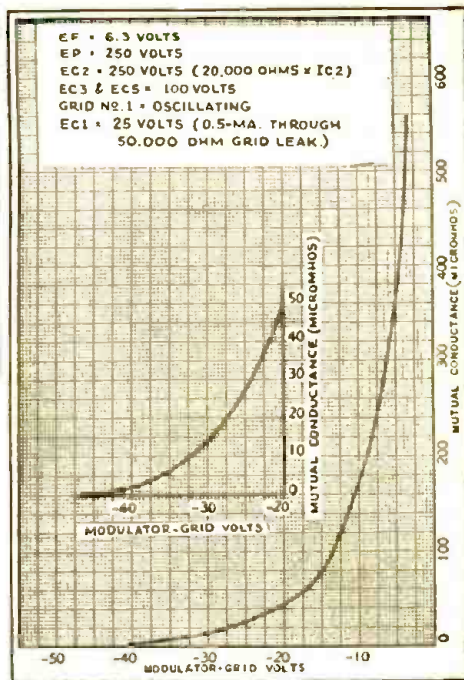

Fig. 4

Curve showing the relation between signal-grid (G4) volts and mutual conductance of the 2A7, 6A7 tubes.

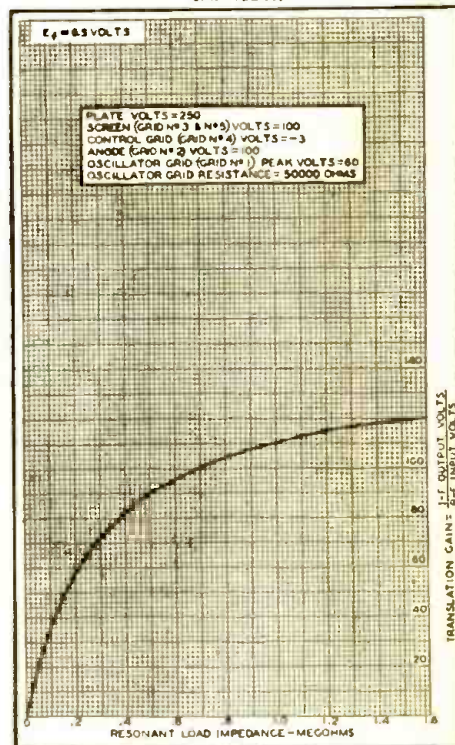

Fig. 5

Load impedance vs. translation gain for the 2A7, 6A7 tubes.

THE TUBES AT A GLANCE

2A6—Duo-Diode Triode

This tube is the same as the 75, but has a filament rating of 6.3 volts. Plate voltage, 250; grid bias, -2; plate current, 1.2 ma.; amp. factor, 100; plate resistance, 90,000 ohms; mutual cond., 100 mmhos.

2A7, 6A7, Electron-Coupled Oscillators

Replaces oscillator and first-detector in superheterodynes. The 2A7 and 6A7 are the same, except for filament rating: 2A7, 2.5 volts; 6A7, 6.3 volts. See text for the characteristics of this tube.

2B7, 6B7—Duo-Diode Pentodes

These tubes have a diode detector and a pentode amplifier in one envelope. They are similar except for the filament rating: 2.5 volts for the 2B7 and 6.3 volts for the 6B7. The pentode may be an amplifier feeding the diode, or vice versa.

6F7—Oscillator First-Detector

This tube is a triode and a pentode in a single envelope. The triode section is the oscillator and the pentode the signal amplifier. Hence, this tube replaces the conventional oscillator and first-detector in superheterodynes.

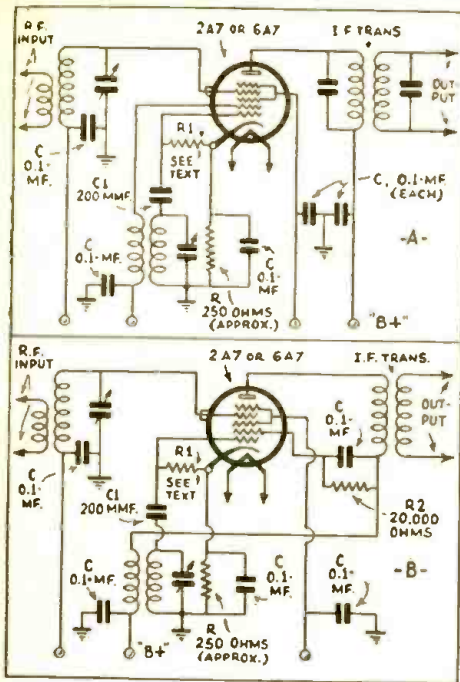

Fig. 6 Two circuits showing how the 2A7 or 6A7 tubes may be connected.

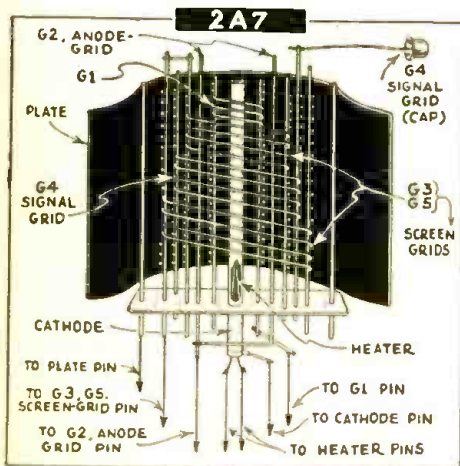

Fig. 7 An interesting drawing of the 2A7, 6A7.

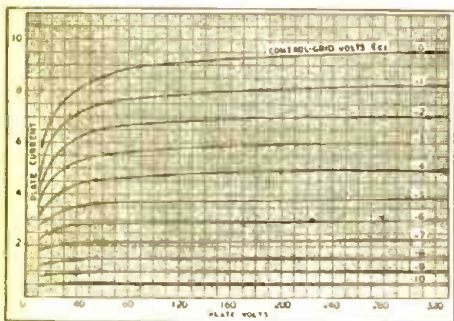

Fig. 9 A family of plate voltage—plate current curves for the 2B7, 6B7 tubes.

in Fig. 5. This curve shows the relation between the translation gain and the load impedance of the resonant plate circuit. It is seen that it is possible to obtain a gain of well over a 100 with this tube—a gain far greater than that attainable with any other previous detector-oscillator combination.

The socket connections for this tube are illustrated in Fig. 1B and two circuits illustrating its use are shown in Fig. 6. The circuit of A is similar to that shown in Fig. 3E. The only difference lies in the use of additional resistors and condensers. Condensers C are .1-mf. bypass units; resistor R is the bias resistor for the modulator section of the tube; R1 is the grid leak for the oscillator section, and its value depends upon the screen voltage—voltage of grids 3 and 5—applied. R1 should have a value between 10,000 and 25,000 ohms when the screen voltage is 50; a value between 25,000 and 50,000 ohms when the screen voltage is 75; and a value between 50,000 and 100,000 ohms when the screen voltage is 100. Resistor R2 should have a value of 20,000 ohms when the plate voltage is 250. This resistor is used to prevent the anode-grid, G2, from overheating and becoming red-hot when the oscillations are feeble and the plate voltage is high.

The circuit at B of Fig. 6 is similar to that shown at A, except that the current for both the screen and the plate flow through the anode-grid coil. This system results in increased stability of output especially at the low frequency end of the scale, although both systems 1 and 2 are very stable.

The following ratings and characteristics for this tube obtain:

Plate Voltage	250 max.	Volts
Screen Voltage (Grids Nos. 3 and 5)	100 max.	Volts
Anode-Grid (Grid No. 2)	250 max.	Volts
Control-Grid (Grid No. 4)	-3 min.	Volts
Total Cathode Current	14 max.	Ma.
Typical Operation:		
Heater Voltage	6.3	Volts
Plate Voltage	250	Volts
Screen Voltage (Grids Nos. 3 and 5)	100	Volts
Anode-Grid (Grid No. 2)	250	Volts
Control-Grid (Grid No. 4)	-3	Volts
Oscillator-Grid (Grid No. 1) Resistor	50,000	Ohms
Plate Current	4.0	Ma.
Screen Current	2.0	Ma.
Anode-Grid Current	3.5	Ma.
Oscillator-Grid Current	0.5	Ma.
Plate Resistance	0.3	Megohm
Conversion Conductance	.475	Micromhos
Conversion Conductance at -42.5 volts on Grid No. 4	2	Micromhos

The following tabulation gives suitable values for different voltages on the electrodes. The value of the grid resistor, R1, for the oscillator is also given:

Plate Volts	S.G. Volts (G3 & G5)	Anode-Grid Volts—G2	Grid Resistor, R1
250	100	250	50,000—100,000
250	75	100	25,000—50,000
250	50	100	10,000—25,000
100	50	100	10,000—25,000

A pictorial view of the 2A7 or 6A7 tube is shown in Fig. 7.

The 2B7 and 6B7—Duo-Diode Pentodes

The name "duo-diode pentode" reveals the multiplicity of possibilities that such a tube presents to the design engineer. These tubes—they are identical except for the heater rating—are designed for performing simultaneously the functions of detection, amplification, and automatic volume control. These tubes have a single cathode structure. The emitting surface on the sleeve in two sections: one for the diode, and the other for the pentode unit. This construction permits independent operation of the two sections and accounts for the flexibility of the tube. This tube takes a 7-prong base, the socket connections for which are illustrated in Fig. 1C. Types 55, 75, and 85 tubes utilize a diode construction similar to the 2B7 tube, so that the important difference lies merely in the use of the pentode amplifier section. In the previous duo-diode tubes, the amplifier section was a triode, and its use was therefore restricted to A.F. amplification. If such a tube is used in the R. F. section, uncontrollable oscillation is bound to result. This undesirable effect has been eliminated by the introduction of a pentode unit, and it is therefore suitable for operation in R.F. circuits; that is, the pentode may feed the diode, or the diode may feed the pentode. The former use is, of course, preferable.

The diode section is admirably adapted to detector service. A diode system is characterized by high rectifying efficiency, furthermore, with proper choice of load resistance, it is possible to maintain the distortion of the rectified signal at a minimum.

There being two diode plates available in these tubes, they may be used in either a full-wave or half-wave circuit. In the latter arrangement, one plate only, or the two plates in parallel, may be employed. Compared with full-wave operation, the half-wave arrangement will furnish approximately twice the rectified voltage. In the latter case, carrier-frequency filtering will be necessary. Filtering is, however, advisable in both cases.

Conventional circuits for a pentode are applicable to the pentode section

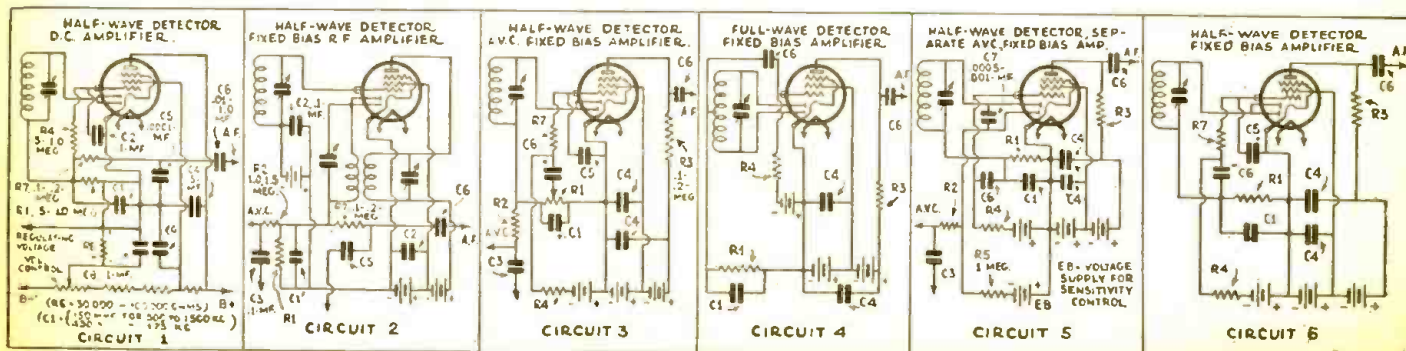

Fig. 8 Six different methods of using the 2B7 and 6B7 tubes. Automatic volume control is not obtained with all circuits.

of the 2B7 and 6B7. The cut-off characteristics are midway between the sharp and variable-mu types, which permits moderate gain control by means of proper grid-bias variation.

The cut-off point and the ability to handle the larger signals may be altered by the choice of screen voltage. A satisfactory method, applicable in many circuits, for utilizing the benefits of extended cut-off is the use of a series resistor in the screen voltage supply. This scheme automatically produces an increase in the voltage applied to the screen whenever the grid bias is made more negative. The choice of resistor will depend on the supply voltage and, also, on the value of grid-bias employed. In any case, the screen voltage should not exceed 125 volts for a grid bias of -3 volts. For larger negative grid-bias voltages, the screen voltage should be limited to 200 volts.

The pentode section may be used in an A.F. resistance-coupled circuit to provide high gain. The grid bias should be obtained from a fixed voltage tap on the D.C. power supply. The resistance in the grid circuit should not exceed 1.0 megohm. Suggested operating conditions for this service are: plate-supply voltage, 250; screen-grid voltage, 50; control-grid bias, -4.5 volts; plate load, 0.2 megohm; plate current, 0.65-milliampere.

The controlling bias voltage for A.V.C. may be obtained in several different ways; and furthermore, the use of this voltage for regulation of amplifier gain is not restricted to a single method. The rectified voltage, which depends on the R.F. or I.F. carrier input, may be obtained from the voltage drop caused by the rectified current flowing through a resistor—R1 in Fig. 8—in the detector circuit of the 2B7 or 6B7.

Other arrangements include: (1) the utilization of one diode for the single purpose of A.V.C., thereby maintaining the sensitivity and time-delay function within the A.V.C. circuit; and (2) the use of the pentode section of the tube as a D.C. amplifier to furnish the requisite control voltage—amplified A.V.C.

Figure 8 shows six different methods of connecting the 2B7 and 6B7 tubes. The values of all parts and the particular connection of the elements are shown on the drawings. In circuit 1, the term "regulator voltage" is the variable bias inserted between the grid returns and the cathodes of tubes under A.V.C. action. Figure 9 shows the family of plate voltage, plate current curves for the pentode section of this tube; Fig. 10 shows the relation between control-grid voltage and dynamic characteristics; and Fig. 11, between screen-grid voltage and dynamic characteristics. The following characteristics for the pentode section of this tube obtain:

Plate Voltage	100	180	250	250 (Max)
Screen Voltage	100	75	100	125 (Max)
Grid Voltage	-3	-3	-3	-3
Amplification Factor	285	840	800	730
Plate Resistance	0.3	1.0	0.8	0.65
Mutual Conductance	950	810	1000	1125

Meg.
Micromhos

Plate Current	5.8	3.4	6.0	9.0	Ma.
Screen Current	1.7	0.9	1.5	2.3	Ma.
Bias Voltage	-17	-13	-17	-21	Volts

The 6F7—First-Detector—Oscillator Tube

The 6F7 is a vacuum tube consisting of a small triode and a remote cut-off pentode. Both of these tubes are enclosed in the same envelope. The primary purpose of the 6F7 is to serve both as the oscillator and first-detector in a superheterodyne receiver. The triode elements and the pentode elements are entirely separate except for a common cathode sleeve; the active emitting area for the triode is not the same as the emitting area for the pentode. A 6.3-volt, .3-ampere filament is employed to heat the cathode of the tube.

The pentode portion of the 6F7 contains a variable-mu cut-off control grid, thus permitting the output of the first-detector unit to be volume controlled. The triode portion of the 6F7, while small, is nevertheless a very satisfactory oscillator tube. The application may well be of the same general type as employed with separate oscillator and first detector tubes. As the triode has its cathode connected to the cathode of the pentode, it will prove convenient to return the cathode circuit through a portion of the oscillator coil to ground, thus introducing into the pentode some of the oscillator voltage, thereby affecting the desired mixing.

The triode characteristics of this tube are as follows: plate voltage, 100; grid bias, -3 volts; plate current, 3.5 ma.; mutual conductance, 450 micromhos; amplification factor, 8.0.

In typical operation the following characteristics obtain: pentode plate voltage, 250; pentode plate current, 5.5 ma.; pentode screen voltage, 100; pentode screen current, 1.5 ma.; triode plate voltage supply (through 50,000 ohms), 250; triode plate current, 2.75 ma.; triode grid leak, 100,000 ohms; conversion conductance, 550 micromhos; plate impedance, 600,000 ohms.

Figure 1D shows the socket connections for this tube and Fig. 12 a typical circuit connection. It should be noted that this tube is not an electron coupled oscillator of the same type as the 2A7. The view, showing the internal construction, is given in Fig. 13.

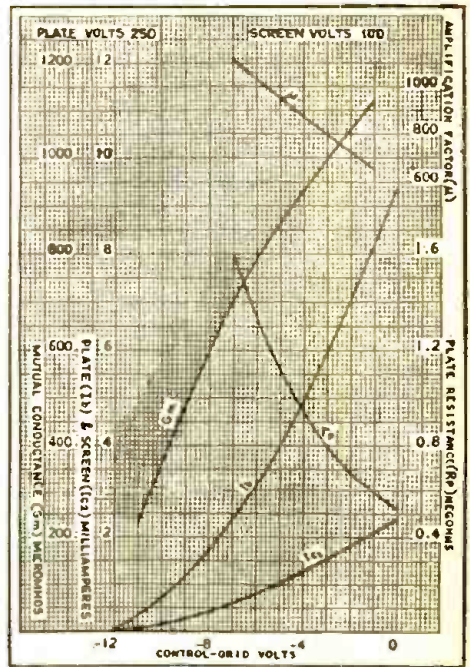
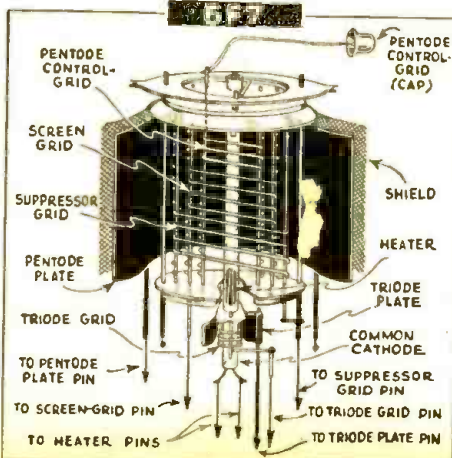

Fig. 10
Relation between control-grid voltage and dynamic characteristics of the 2B7, 6B7.

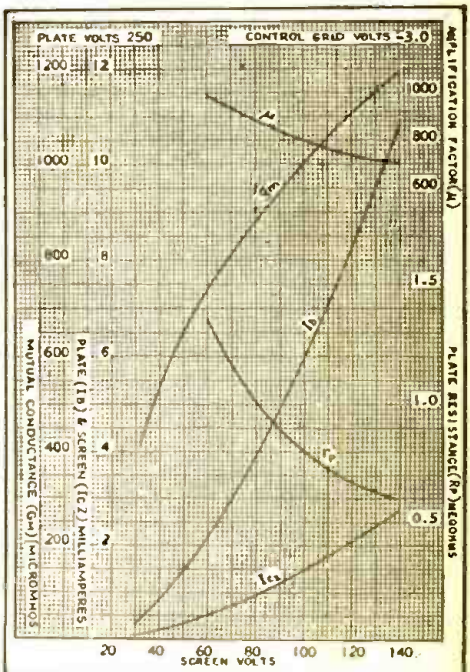

Fig. 11
Relation between screen-grid voltage and dynamic characteristics of the 2B7, 6B7.

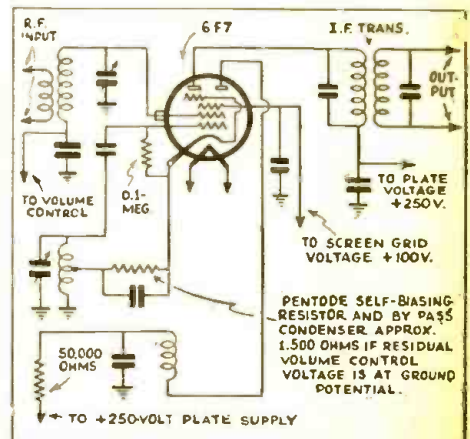
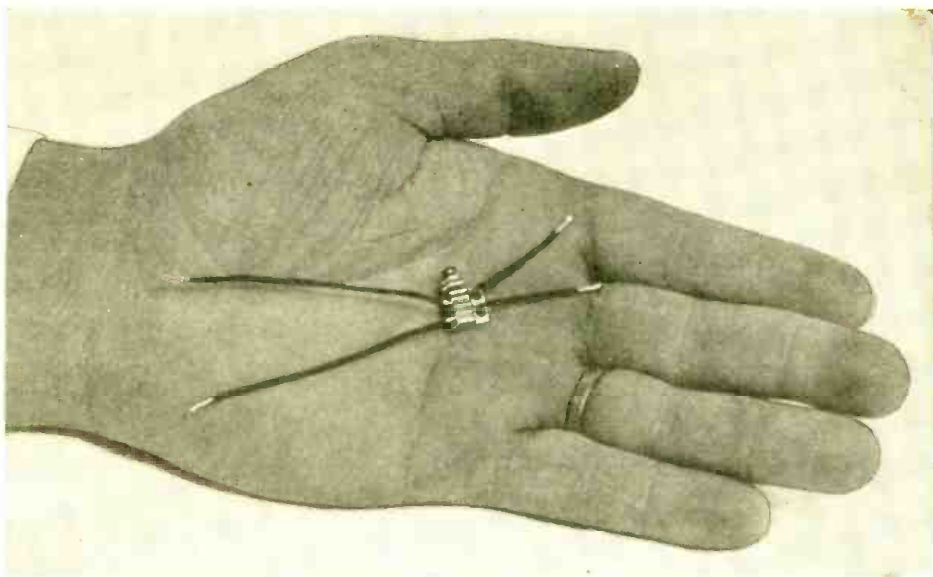

Fig. 12, above
Suggested circuit for the 6F7.
Fig. 13, left
Sketch of the elements of the 6F7.



B. R.
HILL*

An actual photograph illustrating the size of the rectifier unit.

APPLICATIONS AND CHARACTERISTICS OF COPPER-OXIDE RECTIFIERS

THE practical measurement of alternating currents has, heretofore, been made by three types of instruments: the electro-dynamometer, the repulsion or attraction iron vane type and thermo-couple—d'Arsonval type. The electro-dynamometer type has a system of stationary and moving coils without iron in the magnetic circuits; the repulsion iron-vane types have a stationary coil, a movable vane and a stationary vane. Some types of this movement consist of a stationary coil and a single, movable attraction iron vane. In the thermo-couple—d'Arsonval type—a thermo-couple is heated by the alternating current and the resulting thermo-emf is measured by a d'Arsonval instrument. Now we have a fourth, practical A. C. instrument known as the Rectox type. It consists of a copper-oxide rectifier and a d'Arsonval type of instrument. The alternating current is rectified and then measured by

the ordinary direct-current d'Arsonval instrument.

The energy consumption, or the power required to operate the pointer, in the previous types of alternating-current instruments is much more than that required for direct-current instruments. This is because, in a direct-current instrument, the magnetic field is supplied from a strong permanent magnet, permitting a comparatively small current in the moving coil. The higher energy consumption of alternating current instruments has been an application handicap for a long time, especially, where the energy consumed by the instrument would seriously change the circuit conditions, particularly in radio measurements. The Rectox instrument has successfully solved this problem by embodying the high sensitivity features of the d'Arsonval type in an alternating-current instrument.

engineering and research. It is specially designed for instrument use, the requirements of which are considerably different from the usual well known battery charging applications.

The rectifier units are plates of copper which have been oxidized on one side. Copper, when oxidized on its surface, has the peculiar property of rectification, allowing current to flow much more readily from the oxide to the copper, than from the copper to the oxide. The copper plates are assembled and held firmly in place, under constant pressure, by a sturdy clamp, and the entire unit is impregnated to seal it from moisture and corrosion. It is interesting to note that the size of these rectifier units is considerably smaller than the usual battery-charging unit. The relative area of the copper oxide plates greatly affects the performance of rectifier instruments; the proper area of plate has been determined after exhaustive research.

Rectox Rectifier

The rectifier used in the Rectox instrument is a product of Westinghouse

*Meter and Instrument Section, Westinghouse Electric and Mfg. Co.

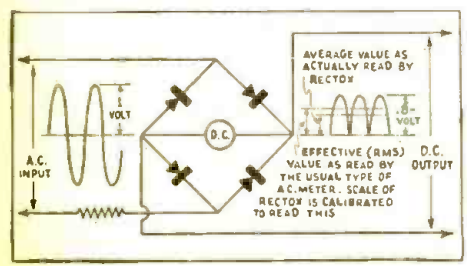

Fig. 1, above
A simple sketch showing the connections and calibration of Rectox instruments.

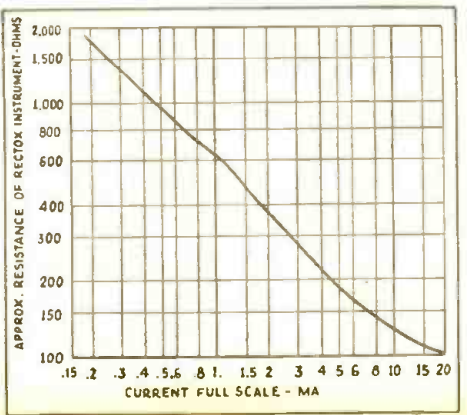

Fig. 2, right
A curve showing the relation between the resistance of and the current through Rectox meters.

The assembly of copper plates is made to give full-wave rectification for all instrument applications. This is accomplished by assembly of the plates into four sections in reverse order and connecting to the instrument as shown in Fig. 1.

Operating Characteristics

The Rectox instrument has certain characteristics which makes its application to measurement of alternating currents somewhat critical. For this reason its operating characteristics should be carefully considered in any application for measurement purposes.

This class of instruments differs from the usual alternating-current types in that the torque and deflection

The copper-oxide rectifier is used so extensively in modern test equipment, and is so little understood, that the editors are pleased to present this excellent discussion of the uses and limitations of copper-oxide rectifiers.



Front view of the new instrument.

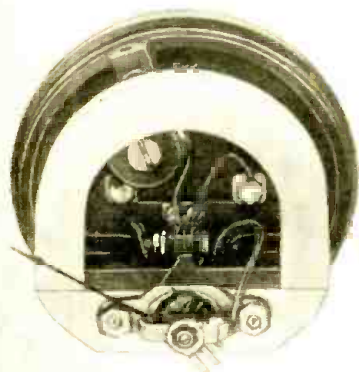

Rear view showing the rectifier.

are proportional to the first power of the current. Therefore, it measures the *average value* and *not* the effective value of the alternating-current wave. The scale is, however, *calibrated to read effective*, or root mean square, values of a pure sine wave. Consequently, such instruments read correctly only on sine waves and have serious errors on other than sine wave forms. These errors can be compensated for in readings, provided the wave form is known from which a correction factor can be applied; or, the instrument may be calibrated on the wave form with which it is used.

The resistance of the Rectox is a function of the current flowing. This characteristic is shown in Fig. 2. When a rectifier-type milliammeter is connected in a circuit, it affects the circuit conditions because of its added resistance, like any other instrument; also the changes in the circuit depend upon

the value of current passing. This disturbance of the normal circuit must be recognized if the milliammeter resistance is a large percentage of the total circuit resistance. If the circuit resistance is relatively high, then this change will result in negligible effects. The instrument always correctly indicates the actual current passing through the circuit; but the magnitude of the current may depend upon the non-linear value of the instrument resistance. (The actual resistance of the Rectox varying with current.—*Editor*)

The readings of Rectox instruments are quite free from frequency errors. The reading may be expected to decrease about 1/2 per cent per kilocycle up to 35,000 cycles, where different conditions occur. Because of capacity effects, this type of instrument is not recommended for radio-frequency measurements. It is, however, reasonably accurate throughout the audio frequency bands.

The effect of current upon the resistance of a rectifier unit has been previously discussed, but the copper-oxide unit also has the property of changing its resistance with temperature; and, furthermore, the amount of change due to temperature depends on the amount of current passing. Temperature resistance curves are shown in Fig. 3. We have, therefore, a very

complex relation between current, temperature, and resistance. As a result of these conditions, a great deal of skill is required in designing a Rectox instrument to prevent errors arising from temperature changes.

Tests show that the effective resistance of a copper-oxide rectifier decreases as the temperature increases. Therefore, if a rectifier instrument should be used as a low-range voltmeter, without suitable temperature compensation, the voltmeter might read as much as 20 or 25 percent high at a temperature of 40° C. It is for reasons of this kind that little success has been met in trying to adapt Rectox units to standard direct-current instruments. Much better results have been obtained by use of specifically designed combinations of instrument and rectifier, in which proper temperature compensation has been developed.

Like all devices of its kind, the efficiency of the copper-oxide rectifier is less than 100%; in other words, if 1 milliampere A.C. is passed through it, the resulting rectified current available for operating the indicating instrument is usually 8/10 of a milliampere, or less. The typical current efficiency curve for a rectifier instrument is shown in Fig. 4. Furthermore, the current—efficiency ratio (D.C. current output divided by A.C. current input) is affected to some extent by temperature

(Continued on page 42)

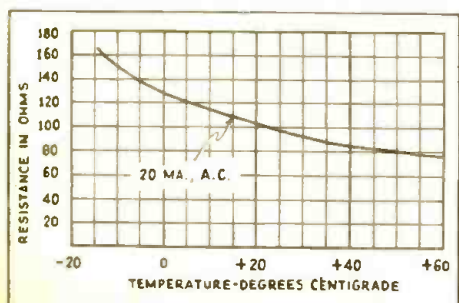

Fig. 3
Curve showing the relation between the resistance and the temperature of copper-oxide rectifiers.

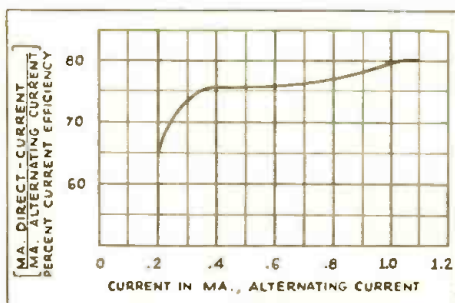

Fig. 4
An interesting curve showing the relation between the efficiency and A. C. input.

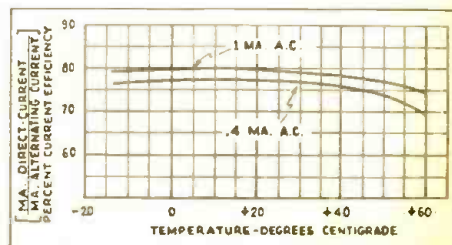
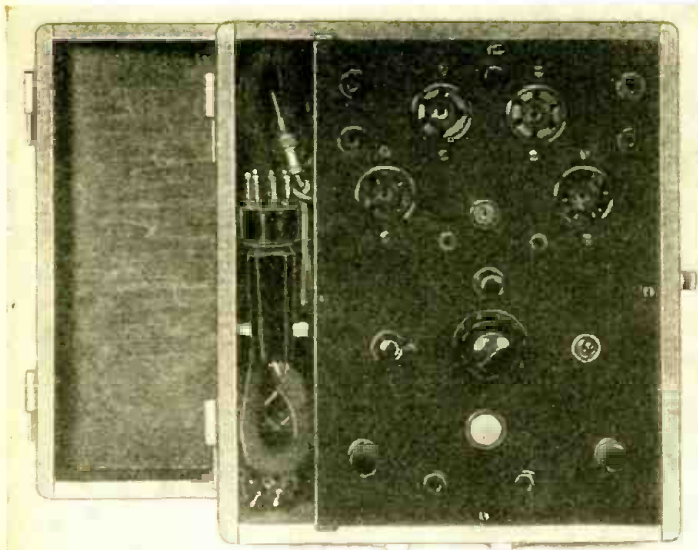

Fig. 5
Another curve, which shows the relation between the efficiency and temperatures of copper-oxide rectifiers. Note the variation with current.



A view showing the Simplicity Analyzer Unit as a separate instrument. See Fig. A.

BUILDING THE SIMPLICITY ANALYZER UNIT

A description of an adapter unit which, when used in conjunction with the versatile volt-ohm-milliammeter, enables all tests to be made.

SOL. D. PRENSKY*

MOST radio men, in getting their equipment, have had the good sense to supply themselves with basic testers for general purposes, such as voltmeters, ohmmeters, milliammeters or combinations of these. It is equally good sense, particularly now, in the interest of economy, to put this general purpose meter to work as a set analyzer, by building a separate analyzer unit to be used in conjunction with the meter unit, and connecting the two individual units by two removable leads. The Simplicity Analyzer Unit, which was designed for just such a purpose, effectively fulfills the switching functions of an analyzer. It affords a means for bringing any kind of meter job up-to-date, without touching the

*Instructor in Physics and Radio, New Utrecht High School.

wiring. It attains simplicity because it sticks closely to fundamentals, and avoids multiple switching arrangements which would complicate the circuit.

This design results in making a permanent arrangement for analyzing any tube among the wide varieties now on the market, including the new tubes with seven elements, without using adapters in the analyzer. In addition, it is capable of meeting the threat of the strange hybrid tubes yet to come. It seems that "the sky's the limit" for new tubes, and such being the case, simplicity is all the more to be desired in spite of the obvious drawback of having two separate units instead of one. This apparent disadvantage is easily overcome by mounting the two units in one box, as in Fig. A. The Simplicity Unit is mounted in the cover fitting a Weston model 663 Volt-Ohmmeter. Such a combination is easily

portable and results in an analyzer that is both simple and basically permanent.

Regarding the type of companion meter for this unit, it need be only a double range voltmeter in order to analyze set voltages. However, it is much more satisfactory to use a volt-ohm-milliammeter combination for complete set analysis. Such a combination meter allows for tube voltage and plate current readings and, if desired, resistance values for point-to-point testing through the tube socket. If the meter has A. C. voltage ranges in addition, other readings may be obtained, such as filament and line voltages, rectifier plate voltages, and output measurements. These A. C. readings may be considered refinements, not necessities. It is enough, at this point, to report that for the actual set testing done with this unit, the writer used the D. C. volt-ohm-milliammeter combination of the type illustrated, and the performance was very satisfactory.

Description of Circuit

The circuit diagram is shown in Fig 1. In working with any socket connections, there is one point that is important to keep in mind, namely socket prong numbers are standard for all sockets, regardless of how the tube elements shift around in different cases; therefore, the whole business is greatly simplified if one learns the standard method of numbering socket prongs. For example, filament or heater prongs are always Nos. 3 and 4; in a 7-prong socket keep these larger holes at the bottom of the circle (when looking down from the top of the socket) and start counting with No. 3 (H) at the lower right, and go clockwise to No. 4 (H), and then Nos. 5, 6, 7, 1 and 2 (P). Number 2 is always the plate prong on all sockets. Thus, for the 4-prong socket, starting again with No. 3 (H) and going around in the direction of the hands of a clock,

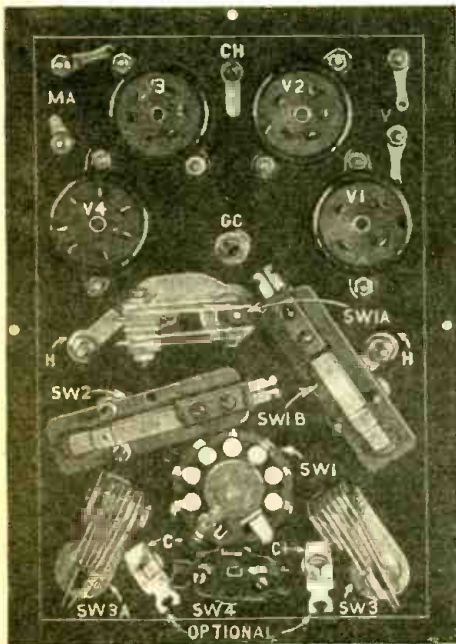

Fig. B
Rear view of the analyzer unit with all components marked.

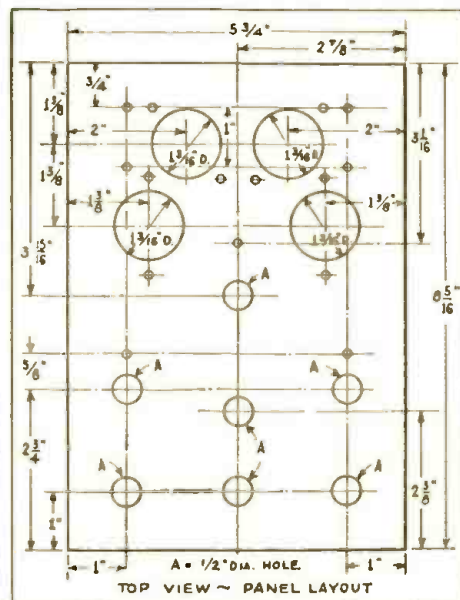

Fig. 2
Mechanical layout of the panel of the Simplicity Analyzer Unit.

FEATURES OF THE ANALYZER

- (1) May be constructed for approximately thirteen dollars.
- (2) Is available in kit form, if desired.
- (3) Facilitates point-to-point resistance and voltage measurements.
- (4) It is a complete analyzer when used with a volt-ohm-milliammeter.
- (5) Is ready for the 8-prong tubes.

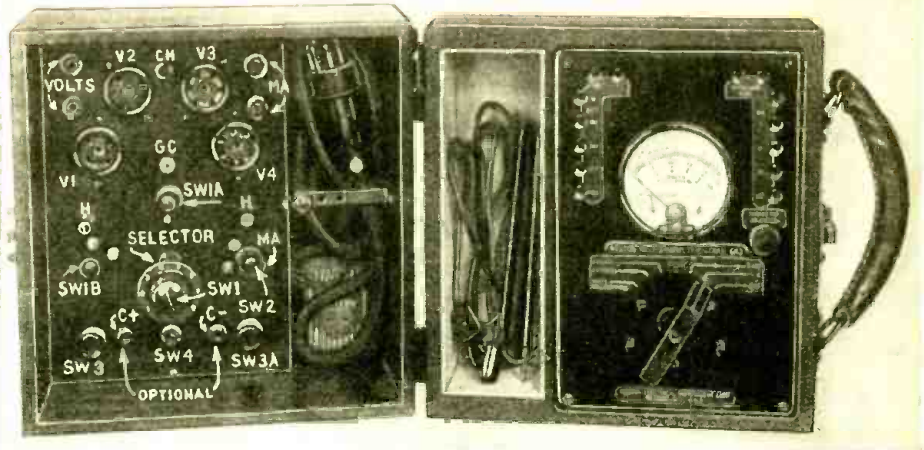

Fig. A
View showing how the Simplicity Analyzer Unit may be installed in a cover of a Weston model 663 volt-ohmmeter.

we have No. 4 (H), No. 1 and No. 2 (P). Notice that Nos. 3, 4, and 2 keep their same meanings, while the other numbers will have varied meanings depending upon the type of tube used. The cap is always the control-grid, G. Referring to Fig. 1, the numbers on the taps of the selector switch Sw. 1 have the same meaning as the prong numbers, with the exception of Nos. 3 and 4 (H-H) which are taken care of by two separate binding posts marked H-H. Thus, if the switch Sw. 1 is turned to tap 2, one side of the external voltmeter—which is connected to posts V—connects to socket connection No. 2 (P) of all the sockets. This not only clarifies the actual wiring work, but also makes it very easy to organize and interpret socket connections by a chart. The other side of the voltmeter is connected through the reference switch Sw. 1A to either K (for heater tubes) or F (for filament tubes). Switch Sw. 1B is then pushed to read the voltage between the two selected points. Switch Sw. 4 is a reversing switch for use when measuring negative voltages. Since we are not using points 3 and 4 on the selector switch for the heaters, tap 3 is called "3-cap", and is connected to the grid clip (GC), measuring grid voltages for tubes with caps. Tap 4 of the switch—note the absence of the socket number, which indicates that taps 3 and 4 are not numbered corresponding to the socket prongs—is called "4-Chassis" and is connected to binding post CH from which an external lead, ending in a spring clip, connects to any convenient part of the chassis. This gives K to CH or K to ground voltages.

For current readings make use of the current button Sw. 2 and grid-shift buttons Sw. 3 and Sw. 3A. The leads from the milliammeter go to binding posts MA. The meter is automatically connected in the plate circuit of the tube by pressing Sw. 2. A correct reading of plate current, obtained in this way, is a sufficiently reliable indication that all the other currents in the tube are normal, making it wholly unnecessary to complicate the circuit with other tube current measurements. Switches Sw. 3

and Sw. 3A are grid-shift buttons, which, when pressed, insert the 4½-V. grid-bias battery in the proper grid circuit while the plate current is being read. Sw. 3A is used only for tubes with caps, otherwise Sw. 3 is pressed. The change in the plate current reading, thus obtained, gives an indication of the condition of the tube. That is all there is to the circuit, and yet nothing essential to analyzing has been omitted.

Construction Notes

The mounting of the parts on the panel, as will be seen from the photograph, Fig. B, takes little space, and even though room is provided for a possible 8-prong socket, the result is a small, compact job. The panel used here measures 5¼ ins. by 8⅞ ins., and may be mounted in a shallow box, 2¼ ins. deep—it is small enough to fit in a Weston model 663 volt-ohmmeter

cover. In the latter case, the small 4½-V. battery easily fits into the cable compartment. Both the panel and these boxes are available together with the kit of parts. Thus, the analyzer unit can readily be combined, both electrically and mechanically, with practically any type of general purpose meter.

As for the actual wiring; different colored wires help to keep the circuits clearly defined; be sure that the wires in the 5-foot cable that carry the filament current are heavy enough—at least No. 18—not to cause excessive voltage drop.

Procedure

(A) Voltage and Current Measurements:

With the analyzer plug in the set socket and the tube in its corresponding analyzer socket, insert the tips of
(Continued on page 46)

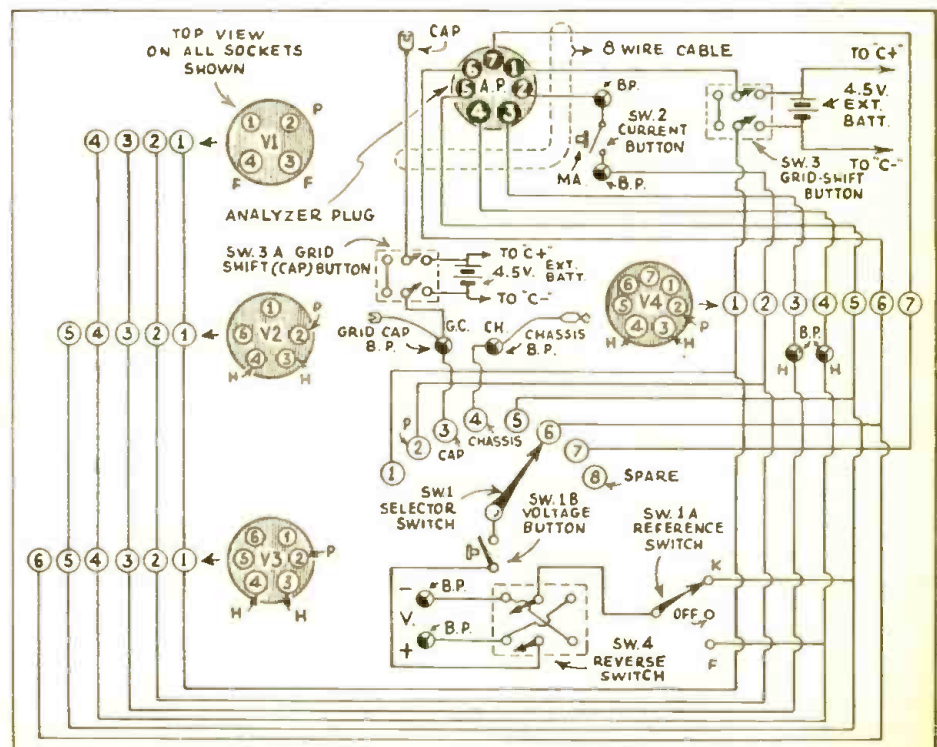

Fig. 1
Schematic circuit. The connections to the tube sockets are shown alongside of the respective socket terminals to facilitate wiring.

BUILDING A POWERFUL 9-TUBE "TRANSFORMER-LESS" A.C.-D.C. SUPERHETERODYNE

A construction article giving details of a powerful 9-tube superheterodyne of the "universal" type. Operating voltages and currents are given.

LEON J. LITTMANN, E. E.*

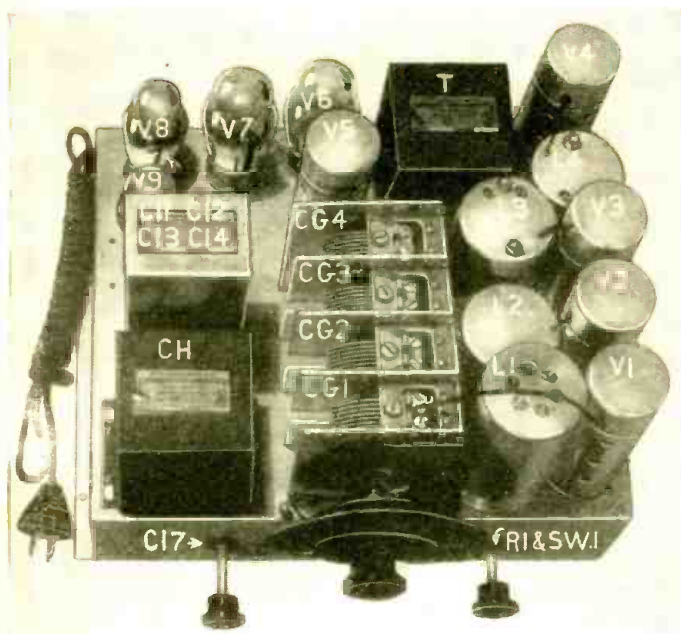

Fig. A
A top-of-chassis view of the modern receiver.

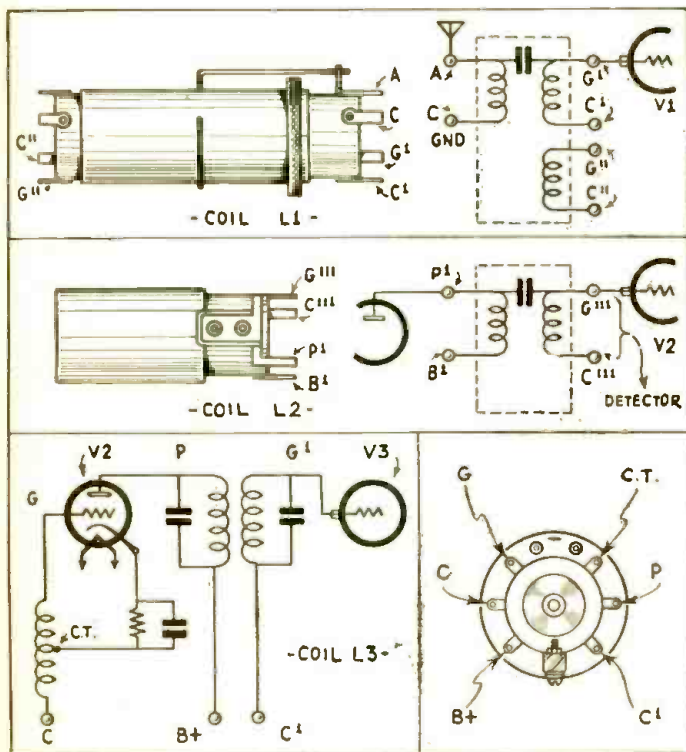

Fig. 2
Coil and socket details of the superheterodyne

THE wide interest shown in the original 5-tube T.R.F. power transformer-less receiver, described in the April 1933 issue of RADIO-CRAFT, in the article entitled, "How to Build a 110-volt, Transformerless Receiver," prompted the writer to perfect another universal-current-operated, power transformer-less receiver of vastly improved selectivity, sensitivity, power output and tonal fidelity.

Sufficient information is contained in this article to enable anyone to build this transformer-less receiver with ease, speed, and complete success. Because all constructional details are given, such as top and bottom view (Figs. A and B, respectively) all component parts employed are properly identified, and a schematic diagram, Fig. 1, makes it easy for a novice to quickly assemble and

wire this receiver; this set design provides the Service Man with a new and lucrative means of income. In fact, this receiver should do much to revive the once considerably profitable custom set-building industry, for this "super" successfully competes with many high-priced, standard brand radio sets, with the advantage of enjoying a much lower production cost and, therefore, a more attractive sale price.

By utilizing a circuit which does not require a power transformer, several advantages are obtained. First, the initial investment is considerably less; second, the weight and size of the chassis are reduced (the entire chassis weighs only 14½ pounds and is but 12 ins. long, 10 ins. wide, and 8¼ ins. high); third, the possibility of transformer breakdown is entirely eliminated; fourth, operating and maintenance costs are reduced.

Due to the extremely high efficiency of the new types of tubes incorporated in this receiver the normal rated output of the set is obtained with a sensitivity of better than 0.25-microvolt-per-meter.

This receiver has an undistorted power output of 8 watts. To attain 8 watts of undistorted output, not only a push-pull output stage was necessary, but also *two type 25Z5 voltage doubler rectifiers* were required. The latter are employed in a unique manner to provide both "voltage doubling" and dynamic speaker field excitation, with this receiver connected to a 110 volt A.C. light socket. The demand for radio sets having a self-contained, high-gain, and high-quality A.F. amplifier such as is incorporated in this receiver and suitable for successful microphone, phonopickup and recording applications, is increasing; only a relatively small number of receivers already built contain an audio amplifier having the necessary gain, and sufficient freedom from distortion to be useful for making high-quality recordings. Therefore, there is the possibility of selling, not only the receiver, but, also, all the additional equipment for these applications.

The Circuit

As shown in Fig. 1, the antenna is connected through an isolating condenser C1 to a litz-wire, bank-wound band selector L1 which feeds into the grid of the first tube, V1, which is a type 78 variable- μ , triple-grid R.F. amplifier. It is mainly through the use of the inductance unit L1, which is capacitatively compensated to assure even gain on both the high and low radio frequencies, that 10 kc. station separation—the ideal figure—has been obtained.

Full gain from this first R.F. tube is realized by using a very high impedance load, L2a. A very small condenser C. of a few micro-microfarads is mounted on the same coil form as L2a and acts as an R.F. coupling condenser between V1 and V2. The inductance in the grid circuit of V2 is tuned by section Cg3 of the gang condenser, is wound on the same coil form as L2a; the shield can is common to both.

One of the latest developments in superheterodyne re-

*Chief Engineer, Coast-To-Coast Radio Corp.

ceivers is the new type 6A7 "pentagrid converter" tube; it is incorporated in this receiver as V2. This tube acts not only as a first—detector and R.F. amplifier, but also as an *electron-coupled oscillator*, and simultaneously as an I.F. amplifier. The circuits evolved for use with these new tubes and employed in this receiver include an oscillator connection which assures a constant output from the oscillator over the entire broadcast band, a condition that is not usually attained with the use of individual detector and oscillator tubes. The construction and use of the corresponding R.F. components are thereby simplified, permitting the oscillator and I.F. inductances to be housed in a common, shielded unit, indicated, in Fig. 1, as L3. As the coupling between the detector and oscillator circuits takes place *inside the tube*, the factor of critical mutual coupling between the oscillator and detector coils is entirely eliminated. The oscillator tank circuit consists of tracking condenser Cg4 and tuning coil L3a. Details of coils L1, L2 and L3 are shown in Fig. 2.

Note that the new 6A7 tube requires a special small-size socket; the 78 uses the old "standard" socket. To permit even those who have little or no knowledge of these new tubes to follow the diagram without difficulty, socket details are shown at A and B in Fig. 1.

The first I.F. transformer, L3, has its primary and secondary windings tuned, to assure high gain; the I.F. is 175 kc. A similar I.F. transformer couples the second, type 78, variable-mu tube, V3, into the type 85, automatic volume control, duo-diode second-detector tube V4. The latter is resistance coupled into a type 37 first A.F. tube, V5, which feeds through a push-pull transformer into two type 18 power pentode output tubes, V6, V7.

The two type 25Z5 rectifier tubes, V8, V9, are connected in parallel and employed as voltage doublers. With this arrangement a current of 110 ma. is available, at 240 volts when the set is operated on 110 V. A.C.; this voltage is necessary in order to approximate the maximum output from the two, type 18 tubes, V6, V7. However, as all the other tubes are designed to perform with practically the same efficiency at 110 volts as at a higher plate voltage, an inspection of the circuit will disclose that tubes V1 to V5 have always about 110 volts applied to their plates, whether the receiver is operated on D.C. or A.C.; a switching arrangement accomplishes this.

This switch, SW.2, is a combination D.P.D.T., and D.P.S.T. unit, located at the rear of the chassis. When the receiver

(Continued on page 42)

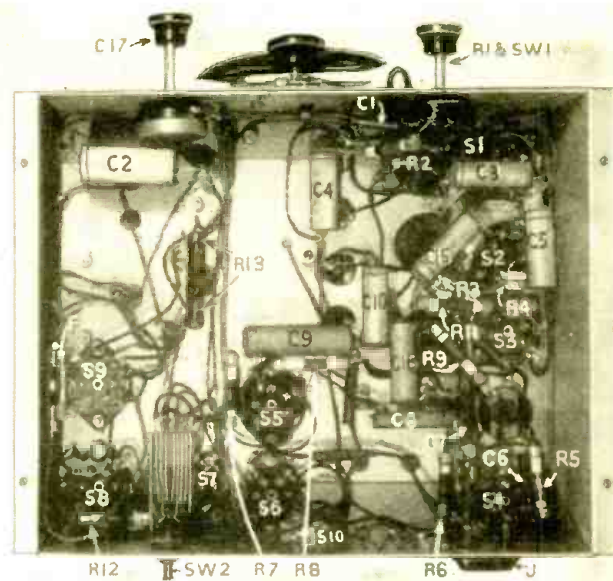

Fig. B
An under-view illustrating the small parts.

The author clearly describes a "man's size" radio set designed on the power transformer-less, A.C.-D.C. principle of operation which made the "ultra-midget" sets so popular last year. Added features are the use of A.V.C., voltage doubling, tone control, the pentagrid (electron-coupled) converter tube, phonograph pickup connections, band-selector, two type 18 power tubes in push-pull, and two type 25Z5 rectifier tubes.

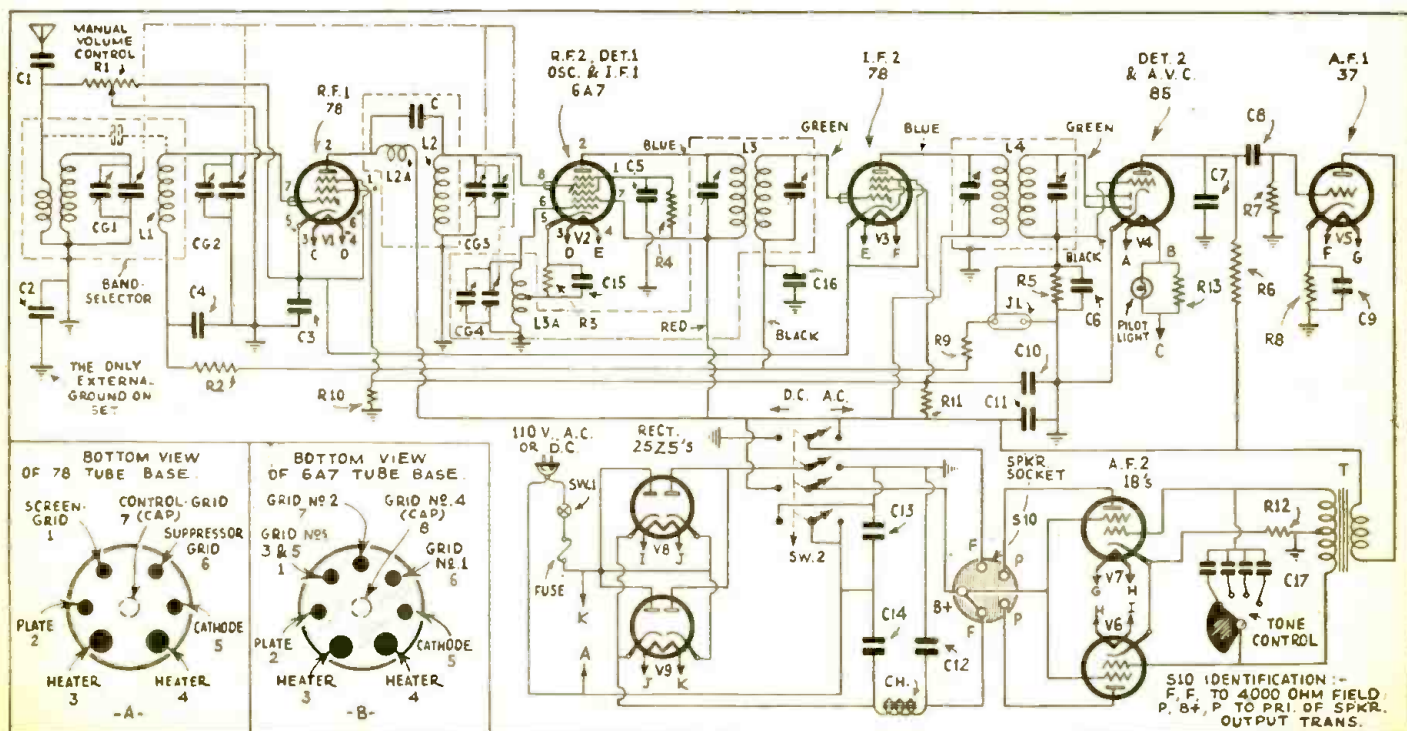

Fig. 1

The schematic circuit of the receiver. Note the use of the very latest tubes available. Truly, a modern set.

BUILDING THE "FIND-ALL" CAR RADIO SET

H. G. CISIN

Construction details of an automobile receiver that may be used in the home as well. It uses the latest tubes available and has exceptional tone quality.

DEVELOPMENTS in the design of automobile radio sets during the past year have been extremely rapid. Improved automotive-type vacuum tubes have recently been produced, and other components, such as R.F. coils, and variable condensers, have been reduced in size and increased in efficiency.

Because of these extensive improvements it is now possible to construct a simple five-tube tuned R.F. receiver having the high sensitivity and power required for automotive work.

Below are listed a few of the features which make the Autovox desirable for the motor car:

(1) It is especially designed to have high sensitivity, so that it will operate efficiently, despite the unfavorable antenna conditions usually present in automotive installations.

(2) Through the use of the duplex-diode triode it is possible to equalize carrier signals to a desired predetermined point by setting the manual volume control. Automatic volume control also compensates for any variation in the carrier signal strength, when

tuning from weak to strong stations, or when passing from an unfavorable to a better location.

(3) Two audio stages assure ample power output without overloading or distortion. Class B amplification in the last audio stage provides an undistorted power output of well over 2 watts.

(4) A 5-inch dynamic speaker gives unusually fine tone quality for this type of radio receiver. Volume, also, is great enough to meet every requirement of automotive work.

(5) The circuit used is simple, hence the set is easy to construct. The two R.F. stages are tuned. Super control (variable- μ) R.F. amplifier pentodes are used in these stages. The 85, duplex-diode triode, is used as a detector. The first audio stage uses an 89 as a class A triode amplifier. The detector stage is untuned, but is coupled to the first audio stage by resistance coupling. The output stage employs a 79 tube, which combines, in one bulb, two high μ triodes designed for class "B" operation.

(6) The receiver, including the dy-

amic speaker, is extremely compact. It is designed to fit into a standard metal "sub-midget" cabinet, 9½ inches long, 4½ inches wide, and 6½ inches high. This compact size assures maximum adaptability to all makes of motor cars. Four "B" batteries are required (provided an eliminator is not used), and these may be mounted in a metal case, similar to the set cabinet, and placed directly behind the set. The complete unit may then be hung on brackets from the under side of the instrument. *Insulate the set from the car; the only connection is at "A—" in the schematic, through the amperite (39).*

(7) The car storage battery is used to supply filament current; less than two amperes are required, and the connection may be made from the instrument dashlight. The ground connection is made at the battery, and hence the only other connection to the set, aside from that for the "A" supply, is the lead to the car antenna. Elimination of remote control and of wiring to "B" batteries, simplifies installation. Furthermore, the set may be removed readily for replacement of tubes or other servicing.

(8) The circuit includes special protective automobile type fuses in the "B" line, and regulating and protective automotive amperites in the "A" line. A motor radio suppressor kit does away with all motor ignition interference.

(9) The chassis is of rigid, durable rust-resistant steel, and the cabinet is of steel, copper skin-shielded to help cut out interference pick-up.

The metal chassis is available with socket and other important mounting holes drilled. Holes fitted with smooth eyelets are provided in the top deck

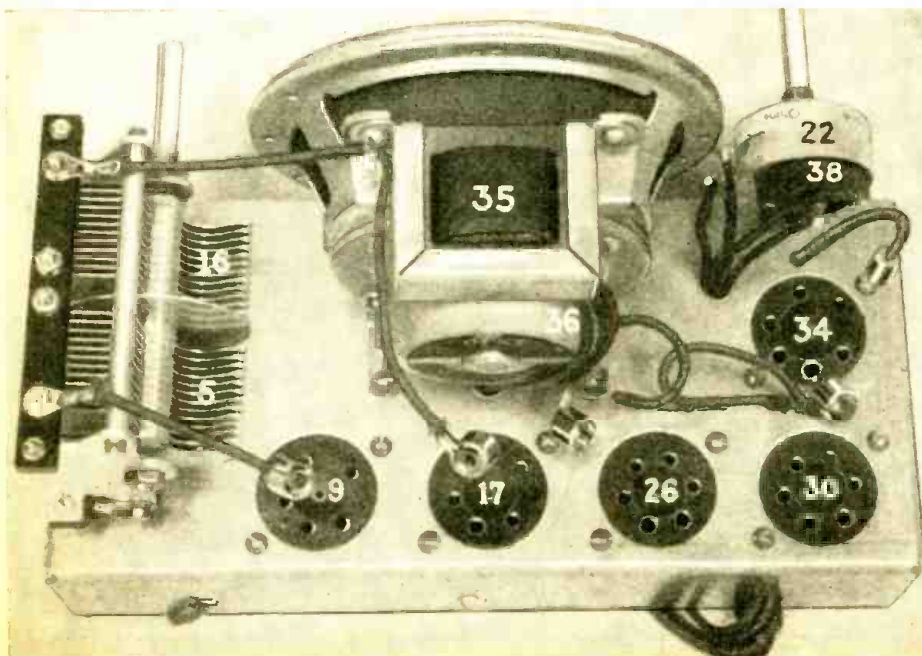

A top view of the chassis illustrating the mounting of the parts.

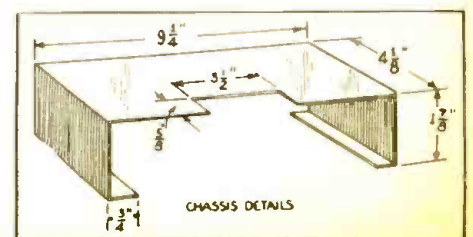

Essential details of the chassis.

The "Find-All" Car Radio Set

This receiver has the following features:

- (1) High sensitivity—making it suitable for auto use.
- (2) Diode detection with automatic volume control.
- (3) It is equipped with a "real" dynamic speaker of the midget type.
- (4) The circuit has been simplified so that it may be constructed easily.
- (5) Uses special coils designed for small space and high efficiency.

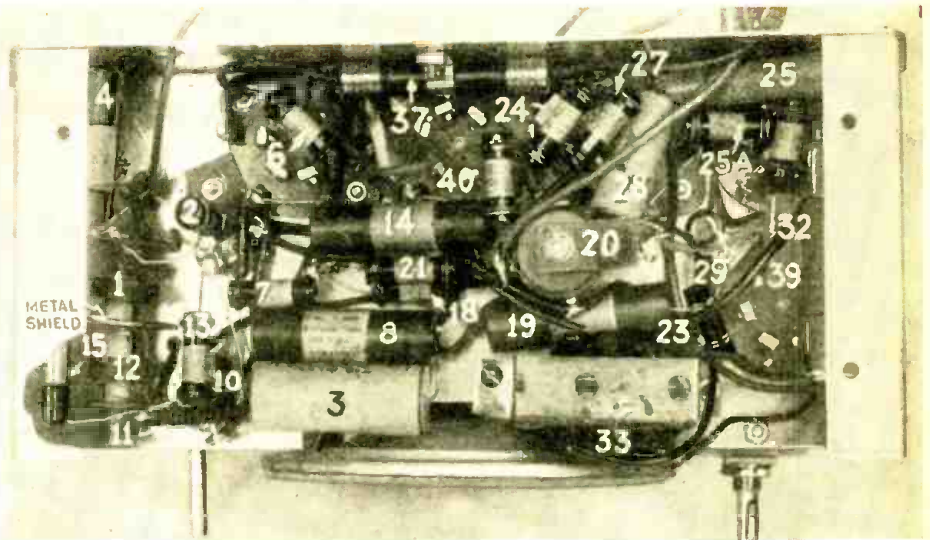

An under view showing the location of the smaller parts.

of the chassis for connections to the volume control, switch and dynamic speaker. There are similar holes in the rear chassis wall for the aerial connection and for the battery cable.

Constructing the Set

The five wafer sockets are mounted first. Then the chassis is turned upside down and the coils (1) and (12) are mounted. A single right-angle bracket is used to hold both coils. A thin circular metal plate of brass or aluminum 1½ inches in diameter is placed between the two coils in order to serve as a shield. Coil (10) is mounted next, in a plane at right angles to the other two coils.

The fuse retainer (37) is fastened to the inside rear chassis wall by a thin metal strap. The No. 16A amperite (39) is similarly fastened to the side chassis wall. The input transformer (33) is mounted on the underside of the chassis, as close to the speaker cone as possible. The untuned R. F. transformer (20) is mounted as indicated on the "bottom view." This transformer consists of two nearly identical coils wound so as to resonate at 550 meters with the internal capacitances of the tubes. The coils are mounted back to back, so that the windings are approximately ½-inch apart. All other parts, which go below the chassis, are fastened in place while the set is being wired. The pig-tail terminals of these parts are soldered directly to the socket terminals or other parts with which they function.

The set is turned right-side up and the dynamic speaker is mounted by means of right-angle brackets. Finally,

the combined volume control and switch and the dual variable tuning condenser are mounted. In placing these two parts, make sure that the shafts line up with the holes provided in the metal cabinet. The Find-All is now ready for wiring. The filaments are wired in first. The negative filament line is grounded directly to the metal chassis, which serves as a common negative return.

All the positive filament socket terminals are connected together with a common lead going to switch (38). The other side of the switch is connected to the "A" plus cable conductor. Grid circuits are wired, then plate circuits, cathodes, bypass condensers, negative returns, primary of antenna coupler, and, finally, the dynamic speaker 6-volt field. In wiring to the various socket terminals, study the diagrams of the socket connections carefully before going ahead. In wiring socket (26) for the 85 tube, note that the two diode plate terminals (the ones directly opposite the large filament holes) are connected together. In wiring socket (30) for the 89 tube, remember that this tube is here used as a triode, so that grids Nos. 2 and 3 are connected together and tied to the plate.

A two-conductor shielded auto radio cable is recommended for the connections to the "A" supply (the car 6-volt storage battery). If the "B" battery is to be located at a distance from the receiver, a shielded "B" cable

should also be used. For suppressing motor radio noises, many suppressor kits are available. These kits usually consist of individual spark-plug resistors and a distributor type resistor. Kits are supplied for four, six, or eight cylinder cars.

In view of the fact that the automotive radio receiver is subject to jolts, jars, and shocks as the car travels over the road, it is very important to use rugged and sturdy tubes.

The Find-All instrument is a powerful five-tube automobile radio receiver employing the very latest automotive type tubes. The circuit calls for two super-control R.F. pentodes, a duplex-diode triode detector, an 89 in the first audio stage and a class B twin amplifier, 79 tube, in the output stage. Automatic volume control is a feature of the circuit. The receiver is so compact that it can be mounted below the car's instrument board, thus doing away with the need for remote control.

List of Parts

- One variable condenser, shielded, .00035-mf. each section, (5), (16);
- One Find-All antenna coupler, (1);
- One Find-All R.F. choke, (10);
- One Find-All impedance coil, (12);
- One Find-All untuned R.F. transformer, (20);
- One Electrad 500,000-ohm tapered volume control, type R1-203-P, (22), with switch, (38);

(Continued on page 45)

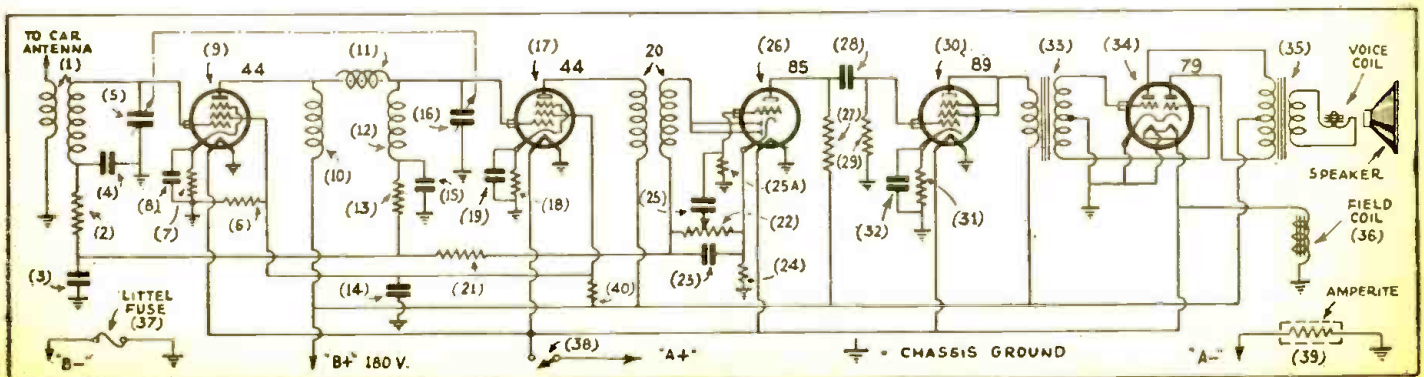

Schematic circuit of the receiver. Note the simple connection of the A.V.C.

POINT-TO-POINT CAPACITY TESTING

A detailed description of a device used for the point-to-point testing of condensers. A comprehensive test procedure is also given here.

ALLEN BEERS

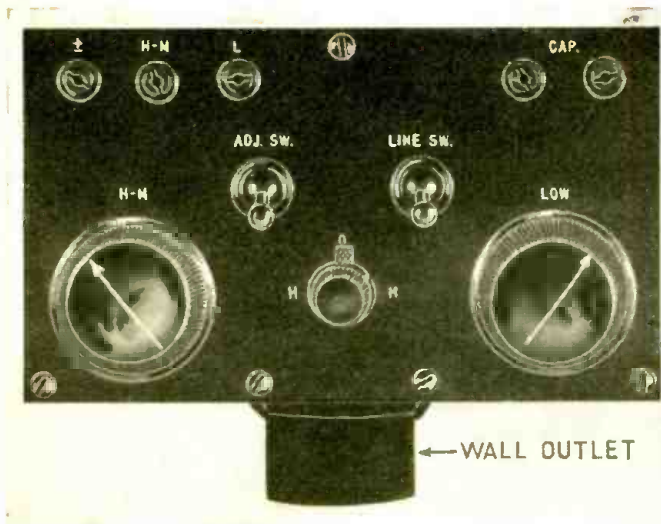

A front view of the point-to-point capacity tester as designed by the author.

EVERY Service Man is familiar with point-to-point resistance servicing, whereby effective resistance values in a circuit are determined by measuring between tube socket terminals and the chassis. It is the purpose of this article to show how condensers that are connected in a radio circuit may be measured for their actual capacity and tested for open circuit by employing the same procedure used in resistance measurement.

Locating an open condenser in a radio set is sometimes a tedious job: tracing through the wiring for the suspected unit, disconnecting it, and applying a high voltage between its terminals or bridging a condenser, known to be good, across its terminals, are the usual processes followed. This method is not only awkward but takes considerable time. The method to be described is fast: the condensers do not need to be disconnected; the chassis does not need to be removed; and the current through the capacity tester will do the tracing for you. Every Service Man will appreciate

these advantages, especially when a test is to be made on a receiver troubled with cutting off, after it has been in operation for some time, so that the test must be made quickly while the chassis is still warm. Of course, not all condensers may be tested in the manner to be described; nevertheless, a surprisingly large number can be tested. Included among these are many that are in common use and develop the most trouble.

As every Service Man knows, the capacity of a condenser may be measured by passing A. C. current through it, the condenser offering a certain amount of reactance to the flow of current, the amount of which is determined by the size, or capacity, of the condenser. This current may be shown by the deflection on a meter. The meter is then calibrated by measuring various size condensers of known capacities; the meter deflections are then put down on a chart for reference. The same procedure is used with an ohmmeter when measuring resistors; but D. C. is used, and, of

course, D. C. will not flow through a good condenser. With the capacity tester, A. C. is used, and A. C. will flow through a resistor as well as a condenser.

Now refer to Fig. 1A. It will be noted that a 50,000-ohm resistor shunted by a .5-mf. condenser is located between the K socket terminal and the chassis. It is desired to test this condenser between the K terminal and chassis. There are two paths for the A. C. current to flow through, as can be seen: first, the condenser; and second, the resistor. Most of the current will take the path of least resistance, and that path, in this case, is the condenser, as will be shown later.

The Chart

From the above, it may be seen that point-to-point capacity testing depends entirely on the path of least resistance, and some means must be found by which this path may be determined at a glance. To accomplish this end, a chart is made of the readings of various size resistors and condensers, using the A. C. supply of the capacity tester. The chart is shown in Fig. 2. This chart shows us the comparative meter readings between different size condensers and resistors, from which the path of least resistance may be quickly determined. For example: note from the chart that under Range 2 a condenser of .5-mf. will give a meter reading of 90 (all readings are taken on the 1,000 V. scale of a universal meter), a resistor of 50,000-ohms will give a reading of infinity. Comparing these two readings, we see that the condenser forms the path of least resistance: that 50,000 ohms is sufficient resistance to prevent all but a small current from flowing through it; consequently, the current is forced to flow through the condenser, and we obtain a meter reading of 90, which corresponds to the capacity of a .5-mf. condenser. By further ex-

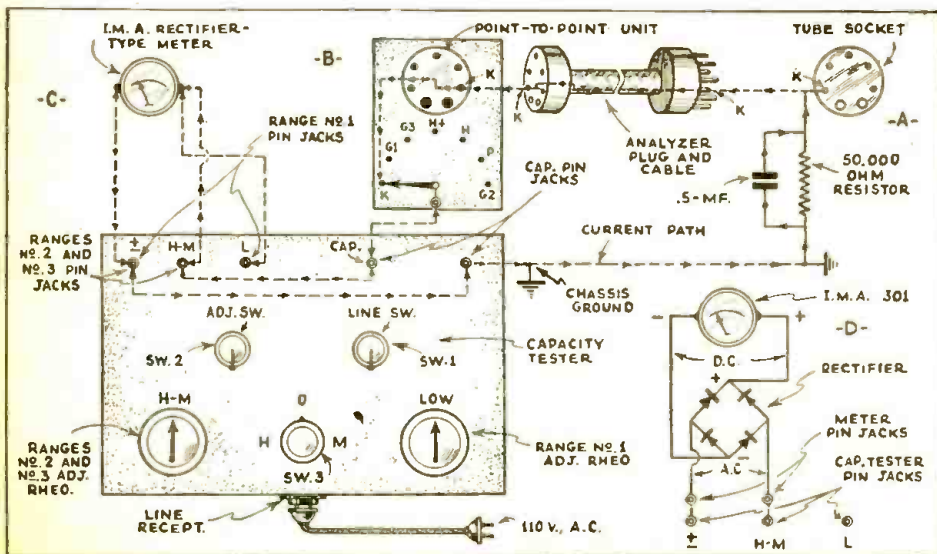
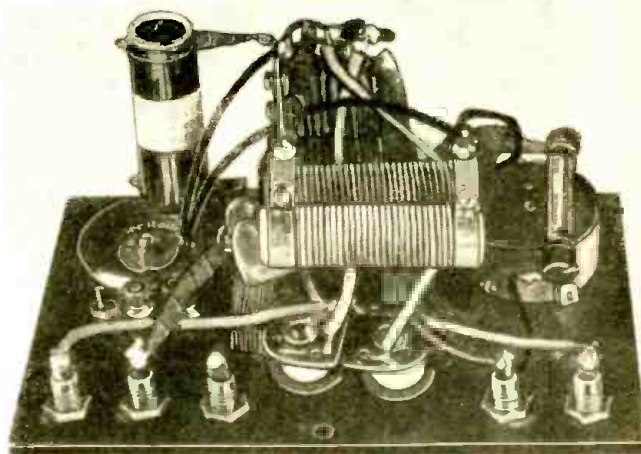

Fig. 1
A pictorial view showing how the point-to-point capacity tester functions.

POINT-TO-POINT CAPACITY TESTING

There is no doubt about the fact that point-to-point resistance measurement, in conjunction with a voltage and current test, furnish a fairly complete test of the usual radio receiver. To make the test more complete, point-to-point capacity testing should also be used. This article explains in detail how condensers in radio sets may be tested without disconnecting them.



A rear view of the modern tester.

amination of the comparative readings of Range 2 in Fig. 2, and with the explanation just given, it can be seen that any condensers measured with Range 2, which have resistors from 20,000 ohms and up connected across them may be measured directly for actual capacity.

A few comments on how the chart is used may be in order. Note that there are three separate capacity ranges. Each of these ranges has a comparative resistance range; that is, each capacity range is capable of reading the resistance, in ohms, of various size resistors. The capacity measurements of Range 1 are from .00025-mf. to 1-mf. The resistor measurements of Range 1 are from 1,000 ohms to 5 megs. Range 2, capacity .1 to 4 mf.; resistors, 55 ohms to 15,000 ohms—infinity at 20,000 ohms. Range 3, capacity 4 to 16 mf.; resistors, 30 ohms to 2,500—infinity at 3,000 ohms.

From this data and from the chart it can be seen that Ranges 2 and 3 will be used mostly where a condenser is in *parallel* with a resistor; Range 1, where a condenser is in *series* with a resistor. Now note Range 1. This range is capable of measuring practically every size resistor used in a receiver chassis above 1,000 ohms, and is very valuable in locating open condensers. First, note that any condenser from .25-mf. and up will read full scale on Range 1. Therefore, if a 100,000-ohm resistor be located in *series* with a .25-mf. condenser, and both units are connected between a tube socket terminal and chassis, and it is desired to test this condenser for open circuit, it can be seen that Ranges 2 and 3 cannot be used: Range 2 will read infinity at 20,000 ohms, while Range 3 will read infinity at 3,000 ohms. Now, by noting Range 1, it will be seen that a resistor of 100,000 ohms will show a reading of 500; a .25-mf. condenser, if O. K., will show full scale, as the current will pass to

the chassis through the condenser. No reading indicates an open condenser. We may say, therefore, that a condenser of this capacity connected in series with any size resistor in Range 1 and located between socket terminal and chassis may be tested for open circuit—the meter reading depending on the value of the resistor. For example, if the resistor were 1 meg., a meter reading of 70 would be obtained; if it were 50,000 ohms, a reading of 650 would be obtained. Any condenser that reads full scale on Range 1 naturally offers no reactance to the flow of current—if it did, the meter would not read full scale.

The above two examples concern two conditions found in any radio circuit, and are: a condenser in parallel with a resistor connected between socket terminal and chassis; and a condenser in series with a resistor between these points.

It is desirable to know the effect between condensers and choke coils, transformers, or any winding with an iron core. Therefore, meter readings of chokes, transformer primaries and secondaries of known D. C. resistance values are taken for Ranges 1 and 2. These are shown in Fig. 2. Note on Range 2 that a choke coil of 300 ohms D. C. resistance will give a meter reading of infinity; also, that a transformer secondary of 2,200 ohms will give a meter reading 330 on Range 1.

Range 3 will read infinity on all iron-core coils. It is clearly seen that it will be a simple matter to measure condensers in parallel with filter chokes, transformer windings, speaker fields, etc., by simply comparing the readings of these units with the readings of the various condensers.

The higher reading is the path of least resistance. For example: if a .05-mf. condenser were shunted across

RANGE No. 1				RANGE No. 2				RANGE No. 3			
CAP. MF.	METER READING	RESISTOR	METER READING	CAP. MF.	METER READING	RESISTOR	METER READING	CAP. MF.	METER READING	RESISTOR	METER READING
.00025	10	5 Meg.	10	.1	10	20,000ohm	Inf.	4	170	3,000ohm	INF.
.0005	20	4 "	20	.25	30	15,000	5	5	255	2,000	20
.001	35	3 "	30	.5	90	10,000	10	6	315	1,000	40
.002	70	2 "	40	1.	280	5,000	55	8	440	750	75
.003	110	1 "	70	2.	550	4,000	60	10	560	500	135
.004	150	750,000ohm	110	4.	835	3,000	110	12	650	400	190
.005	235	500,000	160			2,000	200	14	730	300	240
.006	230	400,000	225			1,000	375	16	790	200	280
.01	390	300,000	275			750	455			100	300
.02	640	250,000	390			500	550			50	720
.03	780	200,000	350			400	620			30	840
.05	950	150,000	410			300	725				
.1	970	100,000	500			200	780				
.25	1000	90,000	530			100	905				
.5	1000	60,000	560			55	940				
1.	1000	70,000	595								
		60,000	630								
		50,000	650								
		40,000	710								
		30,000	770								
		25,000	790								
		20,000	835								
		15,000	875								
		10,000	920								
		5,000	945								
		3,000	980								
		2,000	985								
		1,000	990								

RANGE No. 1		RANGE No. 2	
CHOKES and A.F. TRANS. (PRI.-SEC.)		CHOKES and A.F. TRANS. (PRI.-SEC.)	
D.C. RES.	METER READING	D.C. RES.	METER READING
300 ohm	990	200 ohm	20
700	960	300 ohm	INF.
940	700		
2500	330		
2900	240		
3340	250		
5100	190		

RANGE No. 3	
CHOKES and A.F. TRANS. (PRI.-SEC.)	
D.C. RES.	METER READING
INF. on all	INF.
iron core windings.	

Fig. 2

A very valuable table which tells you what range of the tester to use. Readings for Ranges 1, 2, and 3 for chokes and the primaries and secondaries of A. F. transformers are shown to the left.

an A. F. transformer secondary of 2,200 ohms resistance, by referring to the chart, Range 1, it is seen that meter readings are 900 for the condenser and 330 for the coil. The higher reading of 900 for the condenser shows the condenser may be measured.

In making a point-to-point capacity test it is a good idea to forget about the functions of the various units, as this only complicates matters. We are dealing with the path of least resistance; therefore, the only factor taken into consideration is the resistance, or reactance, of the various units.

Before making a point-to-point capacity test there are a few points to bear in mind. First, condensers and resistors vary in value, by about 10 percent, above and below their rated values; therefore, if a resistor were 10 percent above its rated value and a condenser connected in series with this resistor were 10 percent below its rated value, a difference of 20 percent would result; therefore, allow sufficient margin to work with. For example: note from Range 1 on the chart that a condenser of .02-mf. gives a meter reading of 640; a resistor of 60,000 ohms gives a meter reading of 630. Now, were these two in parallel, it is clear that a positive test could not be made. Second, the test depends entirely on the path of least resistance; and, third, trace the circuit thoroughly from socket connection to chassis, as several circuits may exist.

Tracing A Commercial Circuit

Following is a point-to-point capacity test made on a standard commercial receiver chassis. The model used is a Philco 90, Baby Grand with a single 47 pentode in the output stage. Fig. 1 shows the arrangement and

equipment required for the test. The schematic diagram of the receiver is shown in Fig. 3. Remove the tubes from their respective sockets; and disconnect the line plug, aerial, and ground. Glancing at the schematic diagram, Fig. 3, the first R. F. stage has condenser 35 located between the control-grid, G1, return and chassis. This presents one circuit to chassis. Looking still further, it is seen that there is another circuit through the R. F. transformer windings, the tuning condenser, and the compensating condenser. Further examination shows a resistor circuit, also—resistor 36—this circuit goes further, but let us stop here and consult the values so far involved.

Condenser 35 has a value of .05-mf. (The tuning and compensating condensers cannot be measured with this type of capacity tester, which eliminates this circuit.) Resistor 36 has

a value of 490,000 ohms. We now have two circuits from tube socket terminal G1 to chassis: one through C35, and the second through R36. The question of which offers the path of least resistance is determined by referring to the chart, Range 1. Note that the meter reading for a .05-mf. condenser is 900, while the meter reading for a 490,000-ohm resistor is approximately 160. Comparing these two readings, it is seen that the condenser is the path of least resistance, and, therefore, may be measured.

Insert the analyzer cable and plug between the R. F. socket and the point-to-point unit, Fig. 1B; and rotate the switch on this unit to the G1 position. Range 1 of the capacity tester is used, and the meter is connected to pin jacks ± and L. Close the line switch, Sw. 1, the "Adjust Switch," Sw. 2, and adjust the meter to full-scale deflection with the knob marked "Low" on the lower right-hand side of the tester. Open the adjusting switch, Sw.2, and the test is completed. A reading of approximately 900 is registered on meter, which shows C35 to be normal. If C35 were open, a meter reading of approximately 150 would be had, since the current is forced to go through R36 through R15 and R16 to chassis; the total resistance being 592,000 ohms, which will register a meter reading of approximately 150.

With analyzer plug still in the R. F. socket, examine the schematic again to see if there are any further tests that can be made from this socket. Following the G2, screen-grid, circuit, a resistor 49 is in parallel with condenser 30 between the R. F. socket connection and chassis. The value of the resistor is 70,000 ohms, and that for the condenser is 1-mf. Now noting

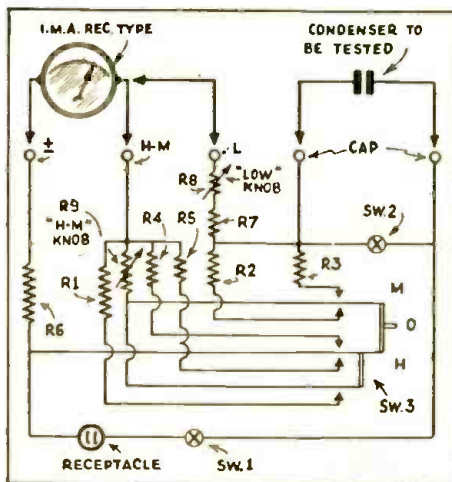

Fig. 4. The schematic circuit of the tester.

(Continued on page 50)

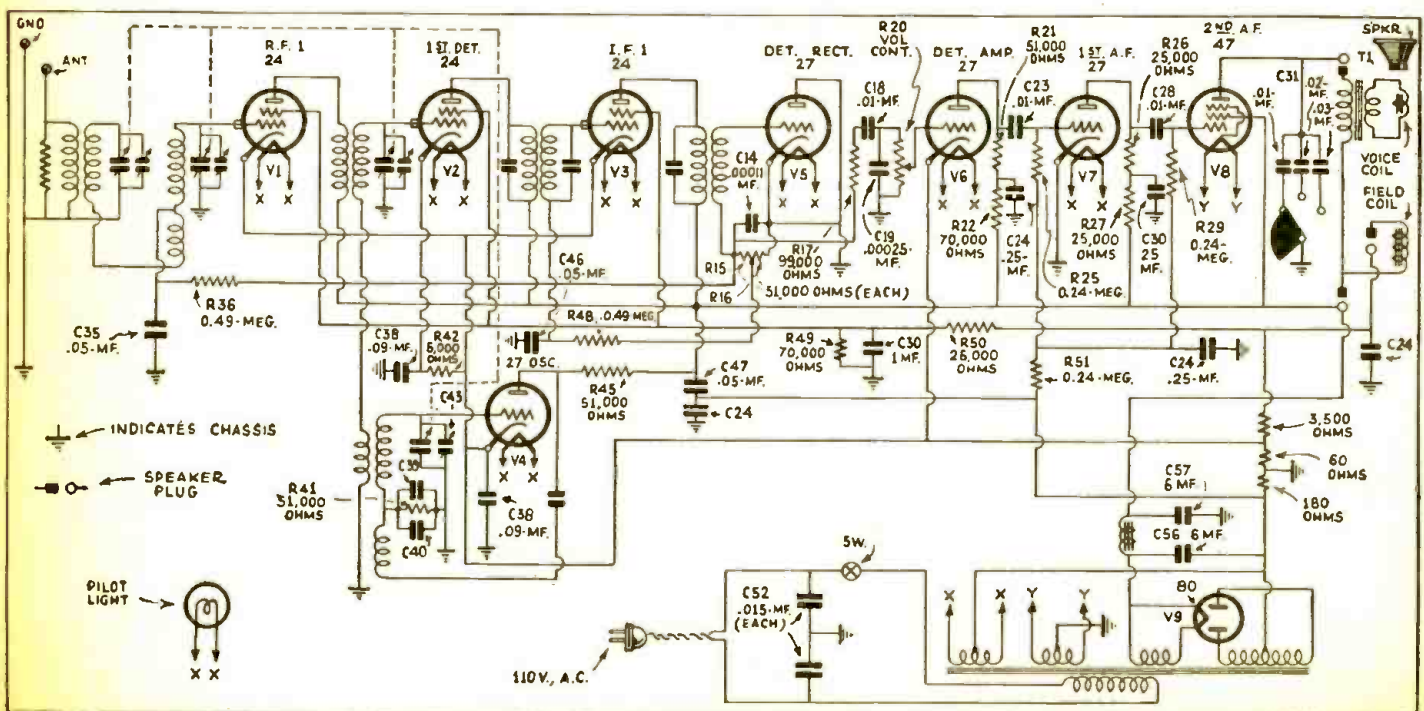
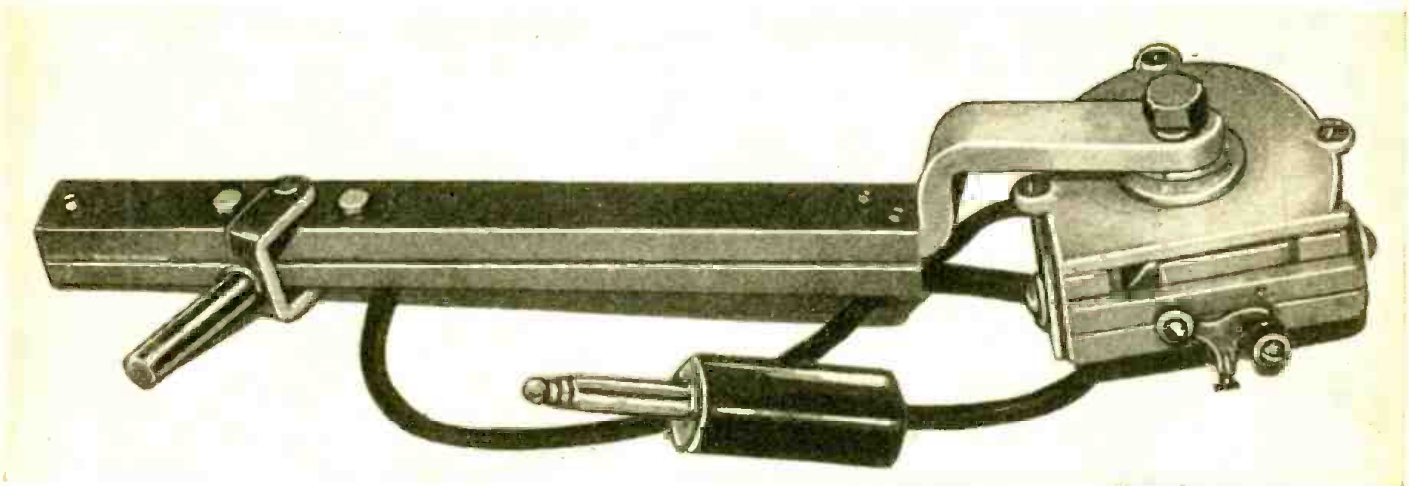

Fig. 3

Diagram of one model of the Philco model 90 receiver which is "analyzed" by the author in this article.



Photograph of the cutting head described by the author. Note the support for the head.

PLANS FOR CONSTRUCTING A HOME RECORDING CUTTING HEAD

W. C. CHENEY

Complete construction details for making your own cutting head suitable for operation directly from the radio set.

HAVE found the cutting head to be described to be superior to many manufactured ones. It is much more powerful and the adjustment of the rubber washer tension on the tone arm makes it possible to emphasize or subdue the low tones of the voice, which, in some cases, is highly desirable.

For use as an electrical pickup for playing home recorded records, it is necessary to place a counter weight on the support arm that will leave a drag of about an ounce on the record. In most cases where it is used as a pickup, a step-up transformer will have to be used. A standard output transformer used to connect the set to the voice coil of a speaker is satisfactory for the purpose. The output of the unit must be connected to the heavy winding of the transformer, and the

fine winding to the set, in the conventional manner.

Construction Details and Sketches

The first step in making the cutting

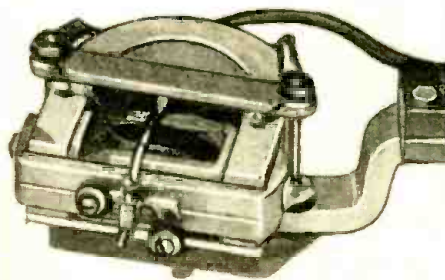

View of the head with the cover removed.

head is to dismantle a Baldwin "Rival" unit. Unsolder the driving rod from the armature; remove the two screws which hold the pole pieces, which will release the bobbin. Remove the wire from the bobbin and rewind in even layers, to the original size, with No. 23 enameled wire. The cutting head may now be operated from the output transformer leads which energize the voice coil of the speaker—the change from radio to recording may be made by a double-pole—double-throw switch. Solder the leads from the new winding to the same lugs to which the old, fine-wire winding was attached. The driving rod, which was formerly attached to the diaphragm, is now attached to the pivot arm, which, in turn supports the recording point.

(Continued on page 45)

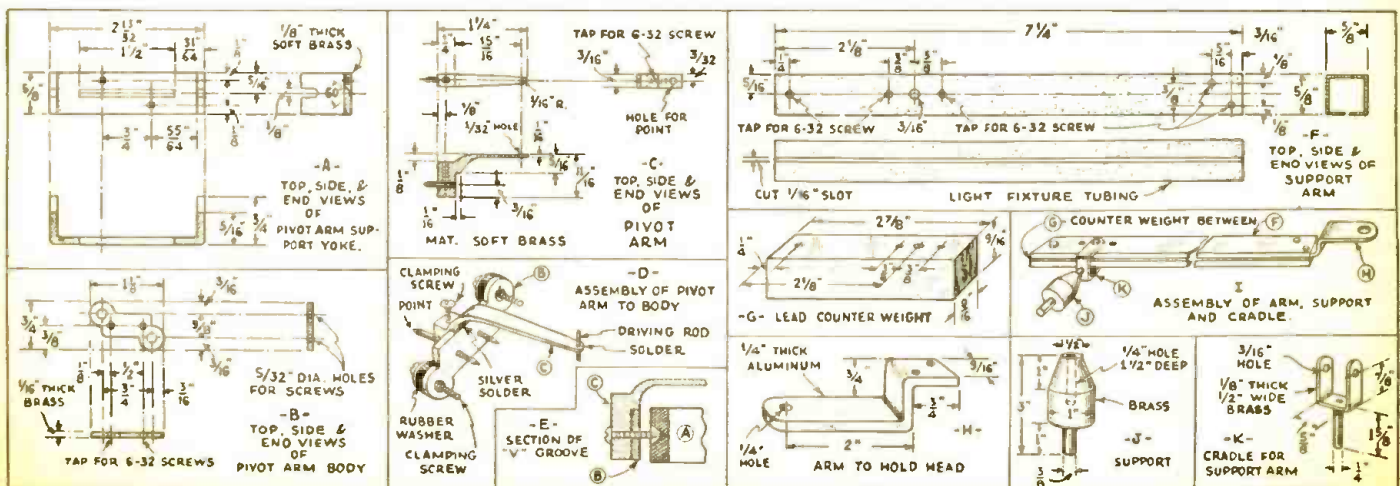

Mechanical details of the cutting head. The dimensions correspond to the photographs above.

BUILDING AN A. C. OPERATED V. T. VOLTMETER

C. B. BROWN



Photograph of the V. T. voltmeter in its case.

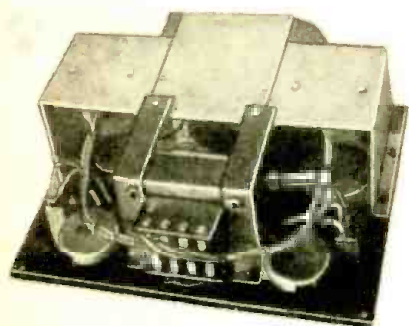

Photograph of the back of the panel, showing all parts.

A VACUUM-tube voltmeter is one of the handiest instruments that the experimenter can have on hand. With it, potentials can be measured without disturbing the circuit to which the instrument is applied. Most vacuum-tube voltmeter designs, however, have been made in portable form by the inclusion of battery supplies. The author constructed such a V. T. voltmeter using a 99 tube, but results were far from satisfactory, due mainly to the running down of the batteries when the instrument was used much. It was decided to completely redesign the old V. T. voltmeter and make it operate from the 110-volt A. C. mains. At the same time, it was considered

desirable to have the instrument entirely portable.

When the problem of redesign was first broached, a careful survey of the available types of tubes was made in order to select the best for the purpose. An 80 was chosen for the rectifier and a 56 for the voltmeter, for the simple reason that an extremely stable system was absolutely necessary, and that the maximum current drain should not exceed 30 mills.

The circuit is shown in Fig. 1. The voltage is supplied from the rectifier-filter system, part going to the plate of the 56, and part going to the voltage divider for the negative balancing voltage. A 1,000-ohm variable resistor, R2, supplies the balancing voltage for biasing the 56 to cut-off, and a 4,000-ohm resistor, R3, acts as a bypass for the plate current when the 56 is at cut-off. The 7,500-ohm voltage divider resistor, R1, is a tapered volume control, and is arranged so as to utilize one control for the entire voltage range from 0-200 volts. Care must be taken to see that the low resistance end is at the low voltage end marked L in the diagram; R4 is included so that the voltage may be reduced slightly. The plate voltage should be adjusted to 90 volts.

A novel use of a new development in the radio field does away with an expensive plate milliammeter. A Readrite tuning meter is used as the current indicator in the plate circuit. Since the tube is operated at or near cut-off, an accurately calibrated meter is unnecessary. The only requirement is sensitivity, and the 0-5 milliampere

model is quite suitable.

An 0-1 milliampere Weston meter is used as the standard for this voltmeter. It is connected through the tap switch, Sw. 3, to the proper resistors. A good meter must be used for this unit, as the V. T. voltmeter is not any more accurate than the meter used to read the balancing voltage. Although any range desired can be used, the author suggests the following:

R6, 2,000 ohm res. for 0-2 volt range.

R7, 10,000 ohm res. for 0-10 volt range.

R8, 100,000 ohm res. for 0-100 volt range.

R9, 300,000 ohm res. for 0-300 volt range.

A separate S. P. D. T. switch, Sw. 2, is included to allow the use of this accurate voltmeter for external work. Thus, it is not necessary to tie up an expensive meter for the exclusive use of the vacuum-tube voltmeter. The use of the blocking condenser, C1, was found to be so handy in the old design, that it was included in the circuit. A S. P. S. T. toggle switch, Sw. 1, is arranged to short the condenser when it is not used.

Construction and Operation

The bakelite panel is used as the base of the instrument, and all parts mounted to it. Figure 2 shows the construction data for the metal sub-panel and transformer braces. These parts were made from heavy galvanized sheet iron. The tuning meter is

(Continued on page 52)

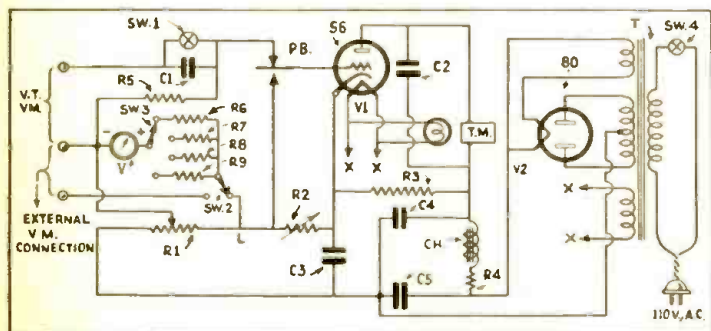

Fig. 1 Complete schematic circuit of the voltmeter. Note that the voltmeter V may be used for external measurements, if so desired, by manipulating switch Sw. 2.

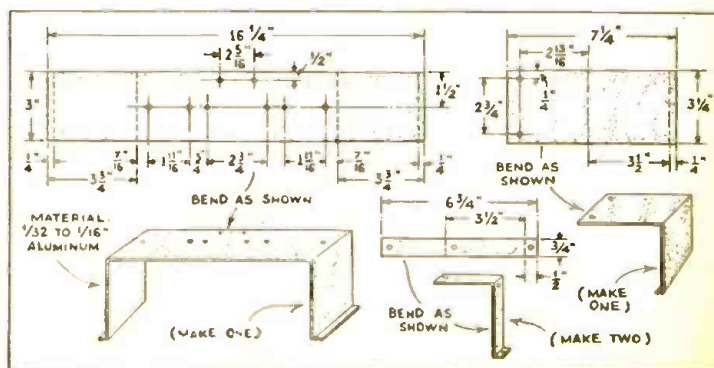

Fig. 2 Mechanical details of the V. T. voltmeter.

LOCATING AND CORRECTING TROUBLES IN PHONOGRAPH PICKUPS

Here are some valuable notes on the proper adjustments to make on the pickup units of phonograph combinations to make the results worth while listening to. Furthermore, by following the author's suggestions, you can "cash in," too.

R. F. LAMBERT

SALES of radio phonograph combinations have thrust upon the radio technician the responsibility for servicing and repairing the pickup unit and its associated parts. Many radio technicians seem to pass up this work entirely, judging by remarks heard in many homes. No one is better fitted to maintain such equipment than the radio technician, and there is opportunity here for a profitable effort that should not be overlooked; which, if properly handled, will work out into a nice little dollar and cents balance at the end of the column.

In spite of its small size and apparent simplicity, the pickup unit has its weakness, which, after it has given very satisfactory service for some time, will eventually show up and will require attention.

The alert radio technician, when encountering a radio phonograph combination, should always inquire whether or not the record reproduction is satisfactory. It is surprising to note how often one hears this remark: "As a radio receiver it worked fine; but as a phonograph reproducer, it no longer gives good results." This information, of course, to our way of thinking, is good news, as right now we are all looking for more work.

The purpose of this article is not to go into details covering the design of the pickup unit, but merely to cover, in a general way, the troubles usually encountered and the methods used to overcome them. Although some of these notes may

refer to some specific receiver, they may be applied to the majority of present-day commercial receivers. Suffice it to say that most, if not all, of the pickup units encountered in our daily service work are of the "low impedance type." See Fig. 1A. Impedances vary greatly in various pickups. The exact location of the pickup output terminals in the receiver and the method of controlling the volume have resulted in almost as many ideas as there are different pickup units. For the exact location and methods used, we refer you to the diagrams of commercial receivers shown in the OFFICIAL RADIO SERVICE MANUAL.

Once in a while you will run across pickup units which are of the "high impedance type." The output terminals of these pickup units are generally shunted with a series resonant circuit, commonly called a "scratch filter." See Fig. 1B. The purpose of this filter is, as its name implies, to eliminate surface noises caused by the needle. The values of the scratch filter were chosen so as to cut off the noise frequencies, without seriously impairing the useful

audio frequencies. Such a filter generally consists of an iron-core inductance of about 200 millihenries connected in series with a fixed condenser of from .004 to .006-mf. The later types have eliminated the filter, since the pickup arm is so well counterbalanced that the pressure at the end of the needle, against the record, is applied in such a manner as to make friction noises almost inaudible.

Pickup Troubles

Before operating with screw drivers and pliers, be sure that proper tests have been conducted in the receiver to prove to your own satisfaction that the radio end of the set is free from defects and that the radio reproduction is normal.

Distortion heads the list when it comes to classifying the most often received complaint. In a few isolated cases, the cause for distorted reproduction was due to nothing but the use of old and worn out records. Many customers seem to forget the very important fact that, in order to do justice to the electrical pickup unit, it is necessary to use none other than electrically cut records. Records salvaged from the old phonograph simply will not do. After records have

been in use a long time, they usually collect a certain amount of dust and grit in the grooves; this dirt, added to the fact that the grooves are probably worn by the needle passing through them a number of times, distorts the signal picked up

from the record. It is desirable, therefore, to first check this item carefully, and the best and quickest test is to play your own perfect record, which should be carried along especially for such purposes. This record will serve another very important and practical purpose, namely to prove to your customer's own satisfaction, after having completed a repair job on the pickup unit, that your work has been properly done and to preclude any possible argument to the contrary.

The first thing to do, in servicing a pickup unit, is to check the speed of the turntable. If a speed indicator is not available, the speed can be checked by placing a strip of paper under the edge of a record so it will just project beyond the edge of the turntable. Play the record in its usual manner, then place your finger where the paper will strike it, and then count the revolutions made by the turntable for one minute. Be sure to have the pickup unit in its normal playing position, so that the retarded action of

(Continued on page 44)

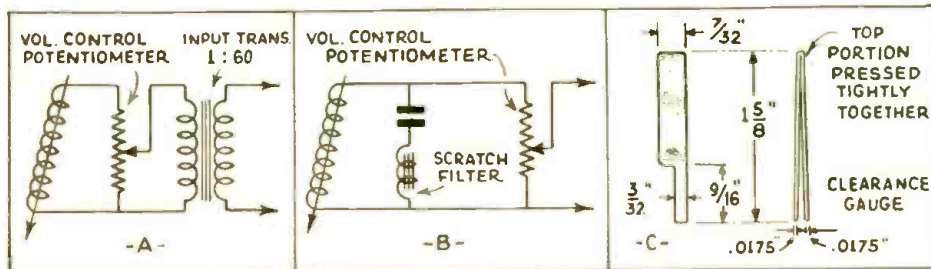

Fig. 1
Some detail sketches of pickup systems and gauges

THE ANALYSIS OF RADIO RECEIVER SYMPTOMS OPERATING NOTES

BERTRAM M. FREED

IN RADIO servicing and repair work, common sense, coupled with practical experience and a good working knowledge of receiver circuits and electrical tests, will enable a Service Man to diagnose and repair any trouble in a radio receiver quickly and effectively. While the radio set analyzer is a great aid in speeding up this work if the operator is capable of intelligently interpreting its readings, too much stress should not be placed upon its use because of the many occasions when this instrument will not reveal complications, and a diagnosis will be impossible unless other means are employed.

The repair of radio receivers through point-to-point resistance measurements is deservedly becoming more and more popular, with some of the more prominent manufacturers falling into line by printing the D.C. resistances of all inductances on their schematics. However, even with this testing procedure, various situations have arisen where knowledge of the mere rudimentary principles of radio theory has not sufficed, but a fuller comprehension of the finer points was essential in coping with the difficulty. With all the new tubes and complicated circuits making their appearance, the Service Man must keep abreast of the times or be left on the wayside.

Philco 70

An unusual situation was recently encountered on one of the Philco 70 models, employing type 35 tubes, and the model 470 with type 24 tubes. The complaint in this instance was no reception on frequencies below 760 kc., with low sensitivity above this frequency. This state of affairs would lead one, at first, to suspect shorted condenser plates as the condenser gang was tuned to the lower frequencies; but the symptoms of weaker response on the higher frequencies and noiseless action where reception ceased tended to overcome this presumption. At any rate, this unit was examined, but no fault could be found with its action. The routine socket analysis was then made—the tubes were previously checked on a tube-checker—without the disclosure of any apparent voltage discrepancies, whereupon the chassis was removed from the cabinet so that continuity and resistance tests could be accomplished more easily.

As the nature of the complaint indicated some defect in the radio-

frequency amplifier, each component in this portion of the receiver was carefully checked with an ohmmeter. The arrangement coupling the R.F. stage to the first detector is an R.F. choke in the plate circuit that is capacitatively coupled to the first-detector tuning coil by means of a single turn, one end of which is free, as shown in Fig. 1A. The purpose and value of this coupling arrangement lies in the uniform gain that is secured over the entire broadcast band. This advantage is lost and the gain at the lower frequencies will suffer, should the resistance of the inductance in the plate circuit be too high.

When this R.F. choke was measured for D.C. resistance, a reading of over 4,000 ohms was obtained. As this value was uncommonly high—the resistance of most R.F. chokes having been found, from past experience, to vary from 50 to 150 ohms—a closer check was made. Finally, the trouble was traced and found to be caused by a cold-soldered

regularly because of blown fuses that it was becoming a nuisance. All conceivable causes for this condition were checked without success; reception could only be restored by replacing the fuse. Finally, one set was encountered with the additional symptom of a "smelly" power transformer. Because of the three type 46 tubes in this receiver, two power transformers with a pair of 83 mercury rectifiers are utilized to meet the unusually high current requirement.

A quick test of the power unit—which, in this instance, was the lower transformer—disclosed that one-half of the high-voltage secondary was shorted. This short was found to be caused by the breakdown of the high-voltage buffer condenser connected across this portion, resulting, of course, in a blown fuse. No fault was found with the transformer, although it must have heated up considerably at the time of the break-down, producing that characteristic odor. When the buffer condenser was disconnected from the circuit and a new high-voltage .1-mf. unit installed, as well as a new fuse, the repair was complete.

In almost every subsequent case where this constant fuse blowing was met, a search for a leaky or short-circuited section of the four-section buffer condenser block was made. These condensers are connected as shown in Fig. 1B. Although the manufacturer specifies .07-mf. as the capacity, the value is not critical, and .1-mf. condensers may be used, providing the working voltage is over 400.

Stromberg-Carlson 38

A Stromberg-Carlson model 38 receiver was serviced some time ago because of the complaint of very weak and distorted reception, the cause of which later proved to be both interesting and unusual. The receiver was tuned to 710 kc., and resonance was indicated by the visual tuning meter, whose action and needle swing were normal. This latter circumstance eliminated from our calculation the possibility of some defect in the radio-frequency stages, and since the set operated exactly as would one with an open voice coil or output transformer secondary, attention was concentrated on this portion of the receiver.

Although it would not have been necessary to unsolder the voice coil leads from the output transformer to

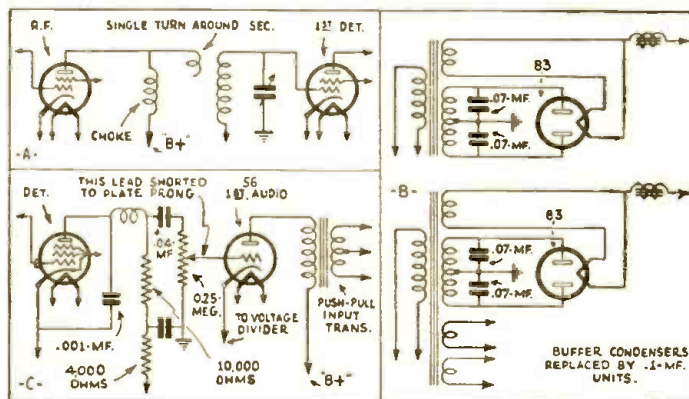

Fig. 1
Detail drawings of the receiver analyzed in this article.

joint on one of the choke pigtails. A hot soldering iron soon remedied this defect and the receiver performed as well as ever.

This added resistance in the plate circuit made so little difference in the voltage impressed upon the plate that the discrepancy could not be noted with the set analyzer.

On this same model, where the lower frequencies are received 10 to 20 kc. above the correct dial setting and difficulty is experienced in aligning the low-frequency padding condenser, the fault may lie with the small bakelite auxiliary condenser that is connected across the padder. An open-circuited condenser here has been found to cause this irregularity.

Atwater Kent 812

A large number of Atwater Kent model 812 receivers were serviced so

make separate continuity tests—because in this receiver the latter unit is mounted on the chassis and is connected to the speaker by the conventional plug and socket—the old reliable and speedy “click” method was used. Each of the type 45 power tubes, when removed and replaced in its socket, produced a loud click in the speaker, indicating an output stage and reproducer that was functioning, but not necessarily one whose voice coil was in perfect alignment. Proceeding with the test, the first audio, 56 tube, was removed to perform the same “click” test, and, to our surprise, the receiver burst into operation with volume that was not far below that of normal! As the volume control—a double unit—which had previously been set at the maximum position, was slowly rotated to reduce the volume, a series of loud clicks, caused by movement of the contact arm over the carbon piles of the Bradleyometer, was heard in the speaker, as if high voltage were impressed upon the control. When the 56 tube was re-inserted, the same weak condition resulted.

The chassis was removed from the cabinet; a close visual inspection of the first audio stage revealed that the lead connecting to the grid prong of this socket, which ran close to the plate terminal, was shorted to the plate prong, whose edges are very sharp. This short placed the full plate voltage of the audio tube upon the grid, but because of the high resistance—.25-megohm—volume control in the grid circuit, no appreciable drop in voltage output was noted; but most of the signal was bypassed to ground with the tube in. When the tube was removed, the signal passed directly to the primary of the push-pull input transformer—without the amplification of the first audio stage. This portion of the schematic is illustrated in Fig. 1C.

RCA Victor 11, 21

A rather frequent complaint on the

RCA Victor models 11 and 21, which are identical except for the dial arrangement, is a noticeable and annoying hum, which may often be intermittent. The usual quick procedure followed by many Service Men in locating the cause of hum—that of removing each tube commencing with the detector, and working toward the output stage, and noting the presence or decrease in hum occasioned by such withdrawal, was employed. As soon as the pentode—a 47—placed directly to the rear of the 80 rectifier, was removed, a severe motor-boating developed, which could not be duplicated when the other 47 was withdrawn.

WHAT THIS DEPARTMENT IS FOR

It is conducted especially for the professional Service Man. In it will be found the most unusual troubles encountered in radio service work, written in a practical manner, by Service Men for you.

Have you, as a professional man, encountered any unusual or interesting Service Kink that may help your fellow workers? If so, let us have them. They will be paid for, upon publication, at regular space rates.

The speaker leads were unsoldered and the chassis was removed. After a good deal of testing of condensers and of point-to-point resistance measurement, the trouble was found to lie in the 1. megohm carbon resistor, connected from terminal No. 6 (chassis) to terminal No. 3 on the phono pickup terminal board, which was shorted to terminal No. 4. This resistor is encased in black spaghetti, and the pigtail is connected to the third terminal. Be-

cause of vibration or jars, it shifted and shorted to terminal No. 4, producing the hum. The remedy is obvious.

When abnormal hum is encountered on these models, all that is necessary is to short terminal No. 3 to terminal No. 4 with a screwdriver. If the hum does not increase and the set motor-boats when the 47 tube behind the 80 is withdrawn, then the carbon resistor is the guilty member.

On these same receivers, noisy tuning, motor-boating, oscillation on the higher frequencies, and the inability to tune to resonance has been traced to poor condenser-gang rotor contacts. Cleaning these contacts will clear up the difficulty; but to prevent a recurrence, it is best to solder a pigtail from the chassis to the rotor shaft.

RCA Victor 77

A stubborn case of fading was experienced with one of the RCA Victor model 77 receivers. It was not the gradual decrease in volume usually associated with fading complaints, but a sudden sharp drop in reception which soon returned to normal, with which we were confronted. The set had already been serviced for the same reason on four different occasions.

The chassis was removed and set up for operation so that a check could be made when the fading developed. After some ten minutes, it occurred—which was sooner than expected. Taking precautions so as not to disturb any part of the set, the condenser coupling the detector plate to the first audio was bridged with a .1-mf. unit, but nothing happened. The screen and cathode bypass condensers were next checked without results (an open-circuited condition in any of these units would cause the fading); but when the first-detector grid filter condenser, connected from the secondary return—which is in the A.V.C. circuit—to chassis, was shunted, the volume came up again to normal.

(Continued on page 49)

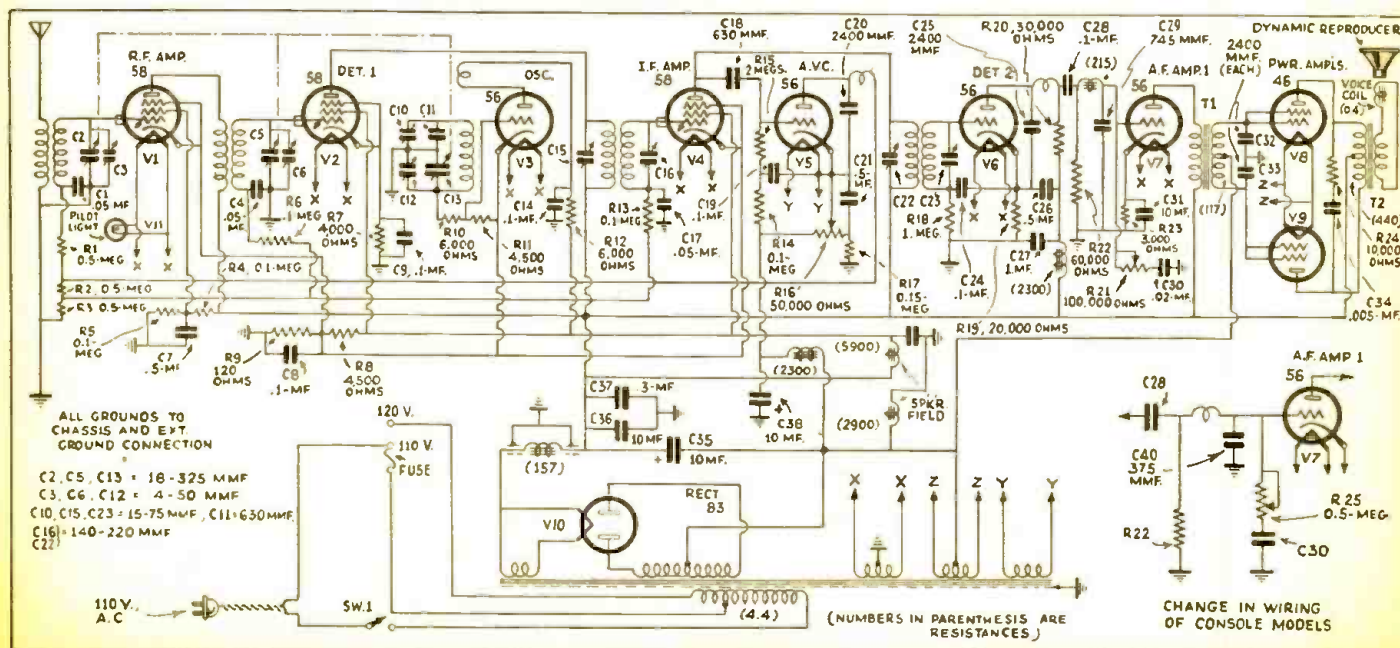

Fig. 2
Schematic circuit of the RCA Victor model 77 receiver discussed by the author. All values are shown.

MOTOVOX MODELS 10A ALL-ELECTRIC AND 10E BATTERY-OPERATED "MOTO-TETRADYNES"

(The model 10A car-radio set is a superheterodyne; the model 10E receiver is a T.R.F. set incorporating a manual sensitivity control; both instruments include A.V.C.)

Latest in the car-radio line of receivers developed by Motometer Gauge & Equipment Corp. are the Motovox All-Electric model 10A, and the Battery-Operated model 10E.

The model 10A 5-tube set installation includes the following items: chassis, remote tuning control, reproducer and harness, antenna lead-in, filter bypass condensers, suppressors "B" unit and harness; a superheterodyne circuit is utilized.

The model 10E 5-tube receiver includes the following equipment: chassis, remote tuning control, reproducer and harness, antenna lead-in, filter bypass condensers, suppressors; a T.R.F. circuit is used.

metal-work. A counterpoise antenna is used in an automobile since no actual ground is available. The height of the antenna is, therefore, equal to the distance between the flat plane of the antenna and the body of the car. Consequently, the most efficient aerial is one in which the capacity of lead-in and aerial matches the antenna stage of the receiver, covers the largest possible area and is as far removed as possible from the body of the car.

The following instructions pertain to the installation of the model 10A set. After mounting the power supply, run the separately shielded red lead, in the reproducer, to terminal No. 3. Next, connect the red lead in the radio cable to the "B+" terminal in the supply and the yellow lead to the "B-" terminal, making certain that the shield of the cable is anchored by the mounting clamp provided in the power supply. Now connect the black, yellow-tracer lead of the tuning control along with the yellow lead from the power supply terminal No. 2 to the ungrounded or "hot" post of the battery. Connect the black lead from terminal No. 1 of the power supply to the grounded battery post. Make certain that the connections to the battery are correct. Do not pull forward the switch underneath the tuning control until the receiver has been plugged into the harness, otherwise, the power unit will be operating without a load.

Installation instructions which apply to the model 10E receiver are as follows. Connect the yellow lead in the "B" harness to the negative tap of the 180 V. battery (four Burgess type 2308 batteries). Next, connect the maroon lead to the "+45" tap, and the red lead to the "+180" tap. In this line is a 1/4-A. fuse.

The sensitivity control on the model 10E set is located in the bottom of the receiver. After tuning the set to a no-signal position near 1,400 kc., turn the sensitivity control right, or clockwise, to "stop," then back it, counter-clockwise, until the static level becomes very high. This is the point of maximum sensitivity, to exceed this will result in lack of sensitivity and A.V.C. It is recommended that this control be set just below maximum sensitivity to reduce engine interference.

Due to the current interest in automotive radio installations the following information concerning car antennas is furnished through courtesy of Motometer Gauge & Equipment Co. Although most of the late car models are equipped at the factory with an aerial of some type, earlier cars will usually require the services of a technician acquainted both with the technique of handling car upholstery and the demands of good antenna design.

It is recommended that No. 14 or No. 16 mesh copper or galvanized screen be used. Do not forget to clear the dome-light by 3 ins. In fastening the lead-in to the screen, a No. 13 insulated wire should be used and if the aerial is copper screen it should be soldered around two adjacent sides so that a good electrical connection is assured. The screen should then be securely tacked at all points possible, making certain that it is not grounded to any metal part of the top. Conceal the lead-in and replace the top, soldering the end of the No. 18 wire to the short shielded lead-in which is provided with most sets, making sure to insulate the soldered joint well; ground the shield to some part of the metal body. Keep the unshielded portion of the lead-in, that is, the No. 18 rubber covered wire, as short as possible so that the shielded lead-in actually enters, if possible, the metal corner post, eliminating the possibility of spark pick-up by the unshielded lead.

Top construction may be divided into the following general classifications:

Open and Convertible. Loosen the top slightly preliminary to putting it back and weave a No. 18 insulated wire around the border between the top and the flap, giving in all a total length of about 60 ft. of wire. Then bring down the lead-in in the manner described above, and re-tighten the top.

Screen Wire Tops. Clip a 3 in. border around the top. Lace the center screen to the edges, using raw-hide.

Standard Fabric Tops. This type of top will be found most frequently. Use a wire screen, as described, removing it 3 ins. from all metals.

Model 10A				
Tube Type	Cath.* Volts	S-G.** Volts	Plate** Volts	
V1	2.0	85	180	
V2	2.7	85	180	
V3	2.7	85	180	
V4	4.5	...	50	
V5	13.5	166.5	158.5	

*Measured to ground; **to cathode. Readings taken with a 1,000-ohms-per-volt meter; "no signal" setting of set. Total drain, 31 ma.

Model 10E				
Tube Type	Cath.* Volts	S-G.** Volts	Plate** Volts	+45** Volts
V1	60	135	1.9
V2	59	134	3.0
V3	59	134	3.0
V4	3.5	40	65
V5	16.0	165	155

*Measured to ground; **measured to cathode. Use a high-resistance meter. Drain, 19 ma.

Sensitivity of models 10A and 10E. 1/2-micro-volt-per-meter; power output, 2.25 w.

Since the intensity of signal strength delivered by the antenna to the receiver is directly proportional to the height and effective length and inversely proportional to the resistance of the antenna, it is necessary to use every precaution to obtain an effective auto-radio antenna installation. Thus, only a low-capacity shielded lead-in should be used; also, the antenna should not come closer than 3 ins. to any

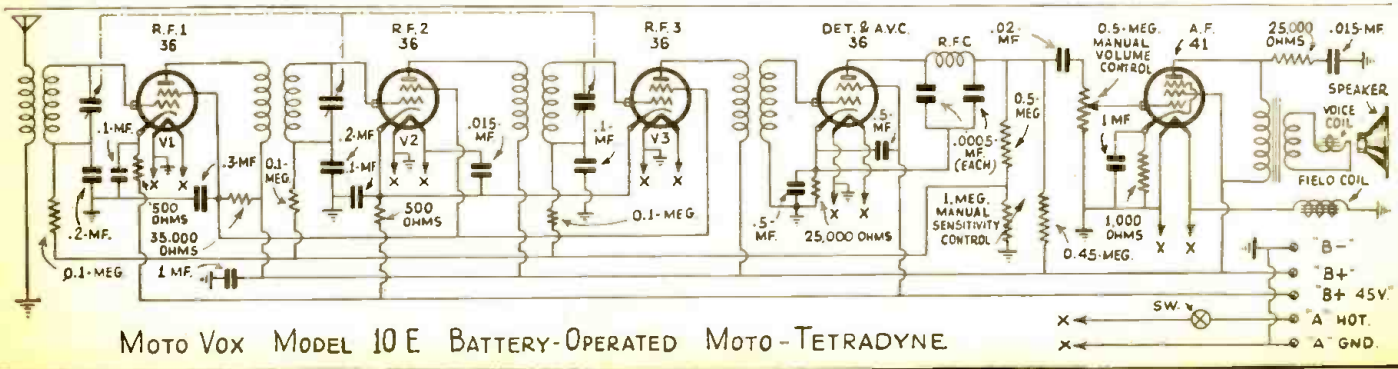
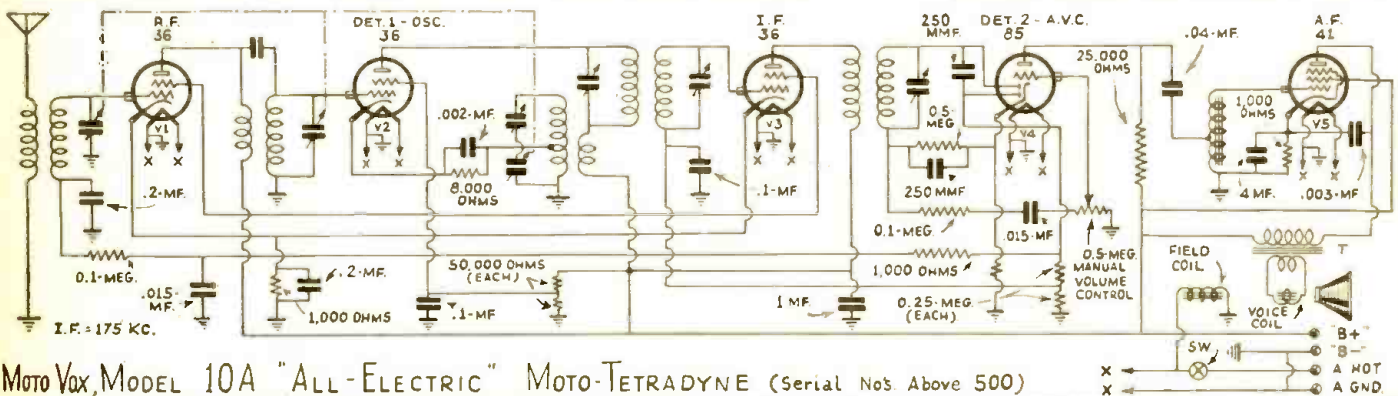

GENERAL ELECTRIC K-40A, PILOT B-2 AND EMERSON 20A AND 25A A.C.-D.C. SETS

General Electric Model K-40A

Tube Type	C.G. Volts		S.G. Volts		Plate Volts		Plate Ma.	
	D.C.	A.C.	A.C.	D.C.	A.C.	D.C.	A.C.	D.C.
V1	2.5	1.5	100	50	200	100	8.0	5.0
V2	5.0*	3.0	95	45	100*	50*	0.2	0.1
V3	18.0	9.0	180	90	170	90	14.0	7.0
V4	115	30.0	20.0

*Impossible to measure on ordinary voltmeter; on 25 cycles the voltages will be lower than those on 60 cycles. Voltages are measured to cathode. These figures are for set adjusted to maximum volume; line potential, 115 V., 60 cycles A.C., or D.C.

Note the use of a voltage doubling connection of rectifier V4; on A.C. the power output is greatly increased. Undistorted power output on A.C., 0.55-W.; on D.C., 0.15-W. Power consumption, 50 W. at 115 V., A.C. Since the frequency range is 540 to 1,710 kc., it is possible to receive police broadcasts on wavelengths below 200 meters.

Check power line characteristics and the position of Sw. 2 before connecting the set to the power line; disconnect the set before touching the chassis.

Pilot Model B-2

Tube Type	Cath. Volts		S.-G. Volts		Plate Volts		Plate Ma.	
	D.C.	A.C.	A.C.	D.C.	A.C.	D.C.	A.C.	D.C.
V1	4.0	58	99	0.8
V2	1.5-30	44	99	4.0
V3	2.5	41	41	0.2
V4	14.0	99	93	25.0

The control- and suppressor-grid voltage for all tubes is zero.

This superheterodyne receiver incorporates several interesting design features. One of the half-wave sections of V5 is used to supply direct current to the field coil of the dynamic reproducer; the other section delivers the high voltage required by the tube circuits. To reduce the hum level of the set a hum-bucking coil is incorporated in the dynamic reproducer. Resistor R2 is part of the power cord.

It is not necessary to adjust a circuit-changing switch when changing from one current supply to the other; tube V5 is in the circuit at all times.

The rated sensitivity of the model B-2 receiver is 100 microvolts-per-meter; the power output is 0.9-W. On A.C. or D.C. the line power consumption is 0.4-A.

Emerson Models 20A and 25A

Tube Type	Cath. Volts		S.-G. Volts		Plate Volts	
	D.C.	A.C.	A.C.	D.C.	A.C.	D.C.
V1	*	10.5
V2	2.5	110	110
V3	10.5	110	110

*Only an indication possible. Readings will change materially regardless of type of power supply. Volume control full on, tuning control set for 550 kc. and the antenna outside of set. Use a meter of 1,000-ohms-per-volt type.

Excessive heat may injure the set; do not place it on a radiator or against a wall.

The models 20A and 25A vary only in the cabinet design. Regardless of the length of antenna used, do not leave any of the antenna wire curled inside the set as this may cause circuit oscillation. To operate the set on a 220 V. line use a limiting resistor in the line. On 32 V. systems use three 45 V. "B" batteries, a 32 V. limiting resistor, and a separate attachment plug; the regular power cord is not used. For 6 V. operation only the three "B" batteries, and an adapter cable and plug are required.

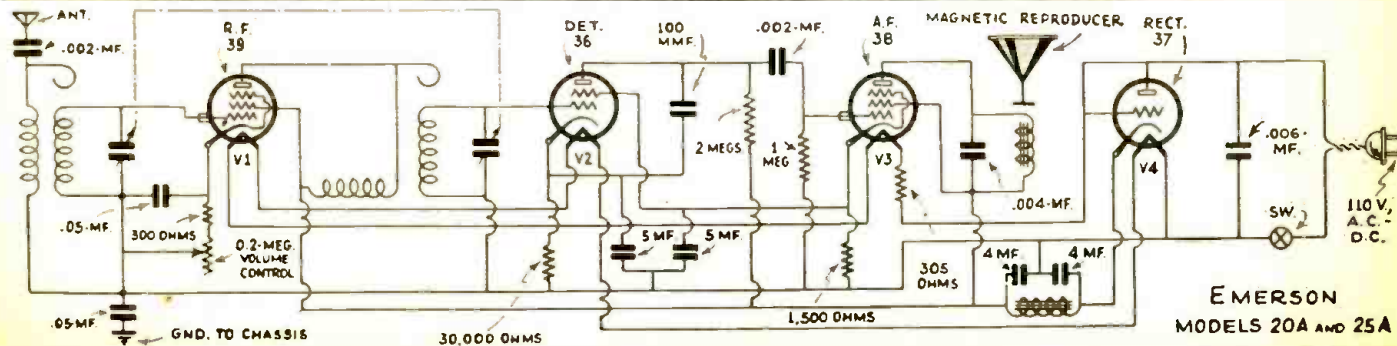
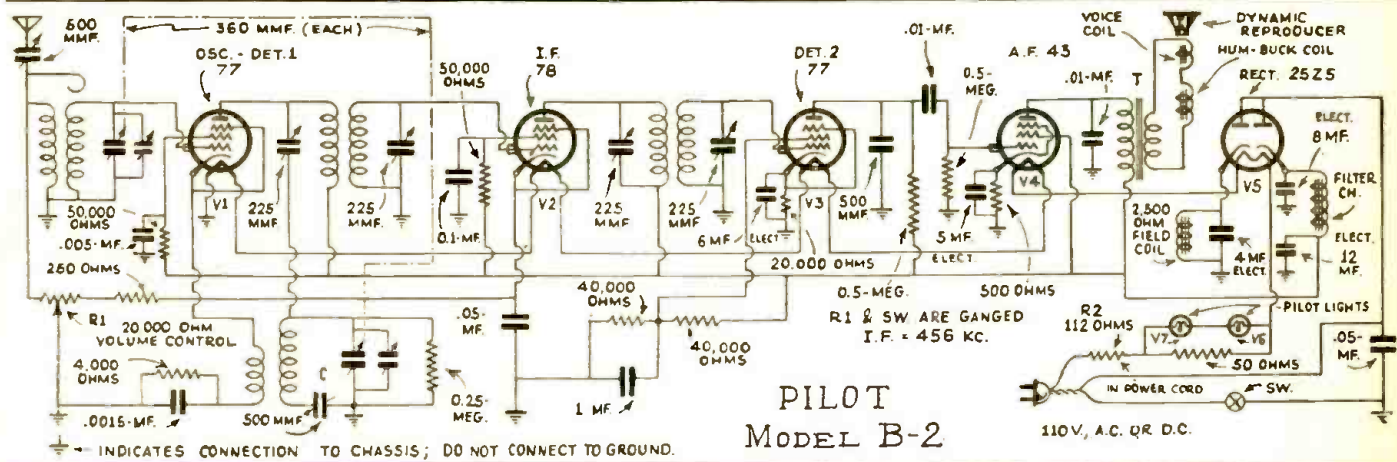
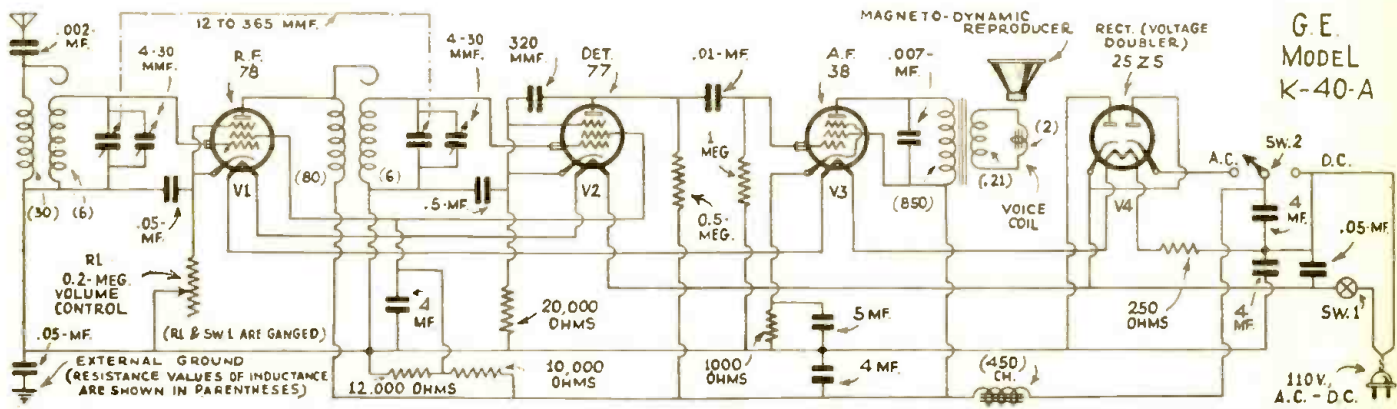

AN IMPROVED POWER CRYSTAL SET

For the crystal enthusiast the author offers a simple "breadboard" set having the following features: Only two "B" leads for all "B" and "C" voltages, regeneration, phonograph pickup connections, broadcast and police-wave reception, loudspeaker operation, and single-dial tuning.

FRANCIS R. HARRIS

LAST month we described in this department, a "power crystal set" utilizing a crystal feeding a screen-grid tube which, in turn, fed a type 31 triode. Those of you who built this set probably found that it would bring in powerful locals on the speaker and quite a bit of DX on the headphones (after the locals had signed off), with the remarkable tone quality one usually associates with the crystal detector. But you found, also, that the set was rather broad in tuning, and that it required quite a powerful

station to obtain really good loudspeaker reception; also, in time, it will be found that, due to the taps on the "B" battery putting an uneven drain upon its various sections, the "B" battery will wear out unevenly, and some sections will require replacing long before others.

It is not our intention to apologize for these faults, they were unavoidable if we were to keep the design simple so that the beginner would have no difficulty in assembling the set; in fact, this design in the past has been con-

sidered "standard"—that's why "B" batteries have an intermediate tap at 22.5 V., and "C" batteries at 1.5 and 3 V. However, a few simple changes in the circuit will eliminate all the above difficulties and give a set that will deliver the utmost in results with the combination of a crystal and two tubes. These changes will be incorporated in the same layout as the original job so that those who have built the breadboard set described last month will be able to rebuild it, with the minimum of trouble, into the improved model.

Requirements

Taking the faults in the order mentioned, let us see what we can do about them. First, there is broad tuning. There are several ways of correcting this fault: We could, of course, add tuned stages, but this would lead us entirely away from our simple circuit and hence is automatically ruled out; we could add tuned stages without amplification, which would lead us into band-selectors and severe loss of signal strength, all very well in multi-tube circuits where we have power to spare, but again out of the question in our simple circuit; or we can go back to the old stand-by of regeneration—the process of taking some of the energy from the plate circuit of a tube and feeding it back into the grid circuit of the same tube—which results in a tremendous increase of selectivity, or sharpness of tuning, and at the same time increases the signal strength.

Now, for the second point, lack of power. There is only one feasible way to overcome this: Use tubes with greater amplification. For our first stage, we must continue to use the type 32 tube since there is no tube available at the present time in the two volt line with a greater mu, or amplification factor. But, for our output stage, we can use a much better tube, the type 33, which has a mu of 70, against 3.8 for the type 31, and a power output of 700 milliwatts, against 185. Of course, the tube requires somewhat more plate current, but its efficiency in this regard is much greater.

(Continued on page 47)

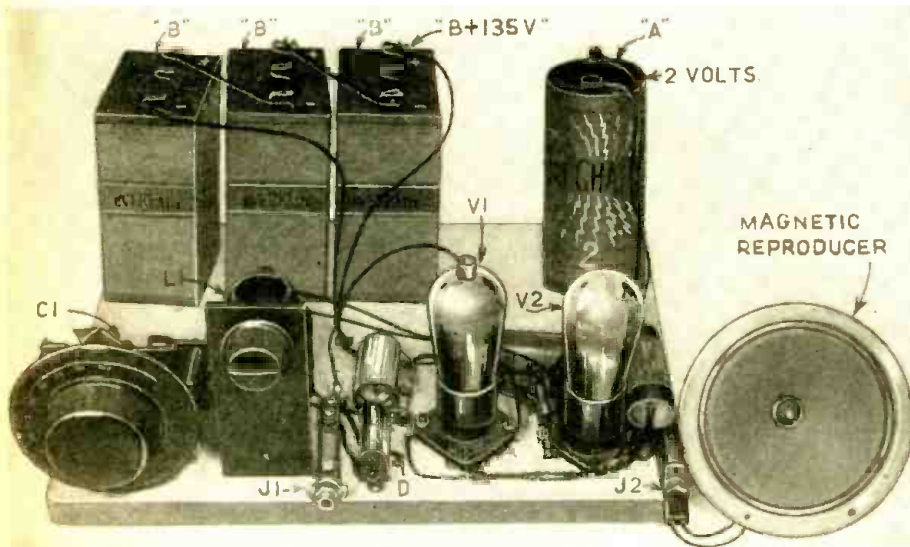

Fig. A
"Breadboard view" of the breadboard receiver described in this article.

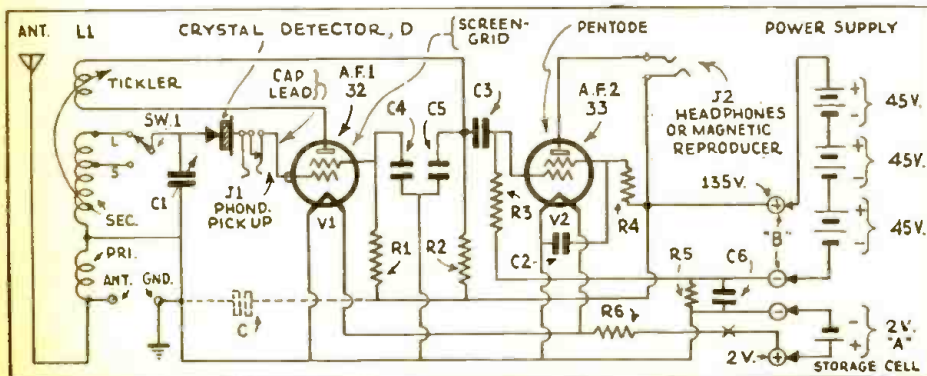

Fig. 1
Schematic circuit of the set. See Fig. A for the placement of the parts.

READERS' DEPARTMENT

A department in which the reader may convey his thoughts to other readers. Included in this department are letters, kinks, short cuts, and experiments. Send in your ideas.

A "SPEED" POWER PACK CHECKER Editor, RADIO-CRAFT:

I have a rather large radio service clientele and complete meter equipment, but still I find that the little device illustrated pictorially in Fig. A and by diagram in Fig. 1 is about the handiest thing in my bag of tricks for quickly locating trouble in power packs.

(The general idea involved is that of the "Speed Tester" described in the November, 1931, issue of RADIO-CRAFT,



Fig. A
Photograph of the "speed" power pack checker.

in the article, "A Speed Tester for Radio Service," by R. Douglas Clerk. However, Mr. Cover's idea of using an inexpensive lamp as the indicating device is novel. Further, he advises that the entire device was developed by him without knowledge of any previous work in this direction.—*Technical Editor.*)

To use the device, insert the regular rectifier tube in the socket, place a 6 V. lamp (a regular 6 V. dial light is ideal for this) in the miniature socket, and insert the device in the regular rectifier socket of the radio set, as shown at 1B. Turn on the receiver and observe the brilliancy of the 6 V. lamp. If the set is working properly, the lamp will barely light. This is assuming use of an average receiver; if an unusually large set is used, the lamp will be brighter. If it lights at more than half brilliancy, it shows an overload on the rectifier tube which can usually be traced to one of the bypass condensers. In case of a severe overload, such as is usually caused by one of the filter condensers shorting, the lamp will, in all probability, burn out. If the rectifier tube has no load, the lamp will, of course, not light at all. In using the method outlined above, no meters are endangered by measuring current which may be excessive.

If the current is found to be under the limit which the rectifier tube can handle, the 6 V. lamp may be disconnected, and the leads which are in parallel with the 6 V. lamp connected to a suitable (0-150 ma.) milliammeter. After noting the current, all the tubes may be given a qualitative test by removing each of them, one at a time, and

noting the difference as measured on the milliammeter.

Of course, if the trouble is found to be caused by a shorted condenser or an open circuit, it is necessary to remove the chassis for repair. Here, again, this little device proves its worth. If the trouble is due to a shorted filter condenser—or some other short—which overloads the rectifier tube, the trouble may be located easily by using the following procedure.

Remove the chassis and connect the speaker in the regular manner. Connect the two leads from the device to a 250 V., 50 W. clear lamp. This lamp requires approximately 250 ma. to light it at 250 V., so that there is little danger of burning it out. Turn on the set. The 250 V. lamp will burn at about one-half brilliancy in case of a direct short, and at increasing brilliancy, depending upon the severity of the short. Do not leave the set turned on more than a few seconds at a time, under these conditions, as all the power is going through the rectifier tube and associated equipment and may cause damage if left on too long. The procedure recommended is to disconnect some suspected part and turn on the receiver. If there is no change in the brilliancy of the lamp, this particular part may be considered as normal. Each suspected part is checked in this manner until the short or other trouble is discovered.

C. WILLIAM COVER,
1618 Hoge Ave., Zanesville, Ohio.

(Continued on page 43)



Fig. B

The real-estate office radio shop of Mr. George Smith of Los Angeles, Calif.

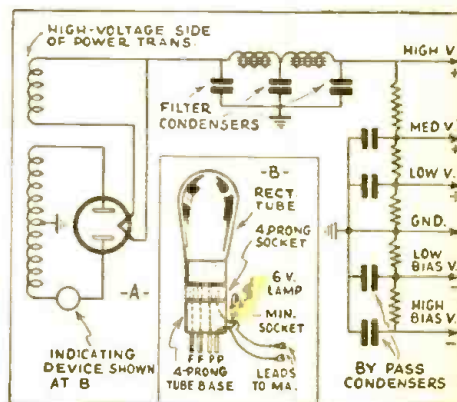

Fig. 1
Schematic circuit of the "speed" power pack checker described by Mr. Cover. Note that the small lamp connects in series with one plate of the rectifier tube. If there is a short anywhere in the power pack, the tube will light up to full brilliancy; if the rectifier tube is defective, the lamp will not light.

THE DX LISTENER'S FORUM

This department is devoted exclusively to the DX radio listener of the broadcast band. In this department are letters from those listeners who achieve unusual results in long-distant reception. We invite all readers of this magazine to forward their list to us for publication. Only the best lists will be published.

TOPPING, EH, WHAT?

If you Atlantic seaboard residents can't "get California on the loudspeaker," you better chase right on across "the pond" and listen-in to the reception of which your English cousins may well boast! As proof, we submit to the DX-fan readers of RADIO-CRAFT the following two letters, by Messrs. "Chestnut" and R. T. Coales, respectively, reprinted from the April 21, 1933 issue of that well-known English publication, WORLD-RADIO.

To the Editor of WORLD-RADIO:

In reply to Mr. Rhodes, may I submit a possible non-technical explanation?

I have a similar receiver and no 'phones. I tried for America early in February and got little between 12 and 1 A. M. About February 9 I tried in the early morning and received twenty-six stations, and on February 12, between 2:30 and 7 A. M., I received fifty-four, including KVV, Hollywood.

I naturally decided that conditions were better after, say, 2 A. M.; but a fortnight later little could be heard, and on one occasion six stations at R7-8 at 3 A. M. faded quite suddenly to nothing at all about 4 A. M. Little has been heard since the middle of March.

The fact that conditions are extremely critical is further evidenced by the fact that, although over sixty stations have been heard, and fifty-two identified in twelve attempts, the twenty or so heard on a fair night are never all the same. KDKA has been received only twice at R3; even WTIC only three times, but then at R8-9! WFAA, WCCO, WHO, KOA, and WEEI have not been heard, nor has any Chicago station, yet WJJO has been heard from just beyond Chicago. Once, when fifteen stations were heard, they included a 100-watt (on 1,210 kc.) station, loud enough to recognize dance tunes, also coming from WNAC, and again WHK, Cleveland (1 kw.), and WDRC, Hartford (0.5-kw.), have been fair signals when neither WTAM, Cleveland, nor WTIC, Hartford, both 50 kw. stations, was even audible.

Altogether, it seems quite possible that little should be heard, even after several attempts, purely by coincidence.

Finally, can any of your readers identify American stations on 236 and 238 meters, and Spanish-speaking stations on 274 and 234, all of which have been heard at least twice?

CHESTNUT, Sudbury, Wembley.

April 7, 1933.

It is unlikely that much more will be heard of the trans-Atlantic stations until the autumn, and it would be interesting if correspondents from different parts of the British Isles would send you their complete logs for last winter. This should give an idea as to how locality affects the reception of certain stations. At this house, for instance, it has been impossible to log KDKA or any of the Chicago stations. My list of stations identified is as under, the figures giving the number of different nights on which each station was heard:

WCAU, Philadelphia, 41; WBZ, Boston, 28; WJZ, Bound Brook, 26; WABC, New York, 24; WPG, Atlantic City, 20; WTIC, Hartford, 19; WGY, Schenectady, 16; LR6, Buenos Aires, 16; LR3, Buenos Aires, 15; LR4, Buenos Aires, 10; WFAA, New York, 12; WAAB, Boston, 11; WNAC, Boston, 10; WOR, Newark, 9; WTAM, Cleveland, 9; WRVA, Richmond, 6; WKAQ, San Juan, 6; WOAI, San Antonio, 5; WWL, New Orleans, 4; WOWO, Fort Wayne, 4; KMOX, St. Louis, 3; WAPI, Birmingham, 3; WLWL, New York City, 3; CKAK, 2; WBT, Charlotte, 2; WCCO, Minneapolis, 2; WIOD,

Miami Beach, 2; WLW, Cincinnati, 2. Also (once only): WJAX, Jacksonville; WLAC, Nashville; WJSV, Alexandria; XEAW, Reynosa.

WCAU has been the most consistent station and has been heard on every occasion that the Atlantic has been "bridged." So well was this transmitter coming over on February 12, that when I retired at 4 A. M. it was easily picked up on an ordinary little one-valver, which I have in my bedroom. The strength was R5, and it was 100 per cent intelligible on speech—a severe test. The set used is a 6-valve superhet. (S.G., Osc., S.G., D., 2 L.F.); 'phones were worn, but most of the above stations have provided fair L.S. reception.

R. T. COALES,
Southsea, Hants,
April 11, 1933.

OK, AMERICA!

Editor, RADIO-CRAFT:

While looking over my past issues of your wonderful magazine, I ran across your "want ad" for DX records.

I got my "Midwest 16" about the 12th of December, but until about January 25, I did no DX-ing on the broadcast band, confining my efforts to the short waves almost entirely.

In our issue of November, 1932, we asked our readers to contribute letters giving the results of their DX experiments. This department is to further efforts in this direction.

There has been an increasing interest of late in long distance reception, particularly in the broadcast field, and there seems to be a race at the present time between owners of broadcast sets and short wave sets to outdo each other in DX performance.

Many people probably do not realize that thousands of broadcast listeners are making records almost daily, and even broadcast reception from Australian stations received in the United States is not impossible today.

In this department, we will publish monthly letters from DX listeners relating to their experiences.

We shall try to publish as many of the letters as we can; but it may be impossible to publish all of them.

We would be glad to have your comment on this new department.

But, since January 25 to April 8, I have logged 394 stations of which 30 are in Canada; 7 are in British Columbia, and includes 1 of 25 watts, 1 of 50 watts, 4 of 100, and 1 of 500 watts. I have heard 11 Cubans, and 11 Mexicans of 50 watts and up. I also have recorded 8 in Australia, 1 in New Zealand, 1 in Venezuela, S. A., and 1 in Honolulu!

Of those in Australia, the two weakest came in best, 4BH, 200 watts and 4BC, 600 watts, both in Brisbane.

2YA in Wellington, N. Z., is the easiest to get and the most consistent performer from the "under side." I get them every night, or morning rather, between approximately three A. M. to 4:30 or so, if the station isn't too bad.

I've had 500 watters from both coasts, Canada, and Mexico.

I must say that 100 watters and 50 watters on the east coast come in lots better than the west coasts, of the same power. On the morning of April 2, WJEJ, Hagerstown, Md., 1,210 kc. completely blocked out all other stations on that frequency.

I would like very much to say that I have a very poor antenna, as I put it up when it was —18° and I wanted to get through. I would like

very much to hear from your readers about aerials and ground.

I use the Radex and Newark Evening News to get unheard stations.

All my best catches I report to the station heard and request verifications. On all foreign countries enclose a reply coupon.

I have raised 33 frequencies at noon about Christmas time.

ALLAN E. KNAIN,
Northwood, N. Dak.

"DX AS IS DX"

Editor, RADIO-CRAFT:

I will give you a little of my experiences re. reception.

One afternoon in January last, on 23 meters, heard calling Tokio, then through this station came a voice which I would have wagered was Floyd Gibbons, having heard him the winter before, through the N.B.C. It was him all right, relating his experiences in the battle area; he must have been speaking from Mukden.

In the same month from RW15, Khabarovsk, 70.65 meters, heard the most perfect English, "as she is spoke." It was a lady, and believe it or not, she was talking of the five year plan and the "profligate idle rich." Those were her

words; and, oh, a lot more which made me think that that country will have to be reckoned with sooner or later. By the way, I had RW15 all last winter and that was the only time I heard the English language spoken. On 25.20 meters FYA, 103 Rue de Grenelle, Paris, the last month or six weeks is coming in fine, but, here's the bugbear, and I am sure most DX-ers will feel the same. As there is absolutely no sense in a code station sending the letter V, 26 times, then his call once, it got so monotonously regular (he kept it up for ten minutes, that I know of), I quit and tuned in G5SW, where I found pretty much the same situation; both these code stations are owned by RCA at Bolinas, Calif. VK2ME, Sydney, 31 meters, up to July 3 last, used to come in between 10 and 12 P. M. every Saturday very fine—since then he changed to nine to eleven P. M.; up to 10 o'clock it is poor but after that he is ok, signing off with that eerie sound of the laughing jackass, several persons having heard it over my phone.

On the 25 meter band, code smothers FYA, G5SW, I2RO and VE9JR. The 31 and 49 meter bands are ok. There is an amateur in Auburn, Mich., WSJR, who must have power to burn—comes in here around three P. M. with a bang. Just what is DX these days?

My idea is, to be able to listen in without having to stay out of bed, for that is the only way a B.C.L. can reach out—or is it? Take these stations in the order as received here: KDKA, W2XAF, W1XAZ, W3XAL (am only quoting these four, as a child could tune them in any day)—so much wallop behind them that the control has to be cut down considerably. Any time between one and nine P. M. People listening won't believe it until the call is announced.

JAS. HEDLEY,
121 23-W.,
North Vancouver,
B. C., Canada.

HERE YA BE, CHARLIE!

Editor, RADIO-CRAFT:

For the DX-ing fool from Long Island: if you will listen-in between six and seven P. M. any

(Continued on page 52)

RADIO-CRAFT'S INFORMATION BUREAU

SPECIAL NOTICE TO CORRESPONDENTS: Ask as many questions as you like, but please observe these rules:

Furnish sufficient information, and draw a careful diagram when needed, to explain your meaning; use only one side of the paper. List each question.

Those questions which are found to represent the greatest general interest will be published here, to the extent that space permits. At least five weeks must elapse between the receipt of a question

and the appearance of its answer here.

Replies, magazines, etc., cannot be sent C. O. D.

Inquiries can be answered by mail only when accompanied by 25 cents (stamps) for each separate question.

Other inquiries should be marked "For Publication," to avoid misunderstanding.

COPPER-OXIDE DETECTOR—ADAPTER FOR TYPE 80 TUBES

(200) Mr. Lester Grey, Chetek, Wis.

(Q.) Is it possible to use a copper-oxide rectifier as a radio detector? These rectifiers are used in conjunction with D.C. meter movements to make an A.C. meter.

(A.) Meter-type copper-oxide rectifiers are not suitable for use in detecting the minute currents used in radio broadcast reception, since the efficiency of such rectifiers in this service would only be a very small fraction of one percent, due to the very great bypass, or condenser action which the large, parallel surfaces present.

However, by following special design, it is possible to produce a "radio" detector of good efficiency. Such a device, known as the Westector, is commercially available in England. A technical description of the design characteristics of copper-oxide rectifiers for use in radio receivers appears in the October, 1932 issue of the PROCEEDINGS OF THE INSTITUTE OF RADIO ENGINEERS.

A schematic circuit, recommended by AMATEUR WIRELESS, for the use of the Westector as a diode-type rectifier, is shown at A in Fig. Q 200; a circuit, for the domestic design, full-wave type, recommended in the Proc., I.R.E., is shown at B.

PHILCO 6F "B" UNIT—SHURE 99 RADIO-MODULATOR

(201) Mr. Henry Parnab, Woodstock, Va.

(Q. 1) What is the difference between the Philco model 6 automatic radio receiver, and the model 6F?

(A. 1) The former uses a dynamotor type of "B" supply, as illustrated and described in the June, 1933 issue of RADIO-CRAFT, the latter uses a vibrator-type "B" unit, the circuit of which appears in Fig. Q.201A.

(Q. 2) Is it possible to connect a microphone directly to the antenna and ground posts of a radio set, talk into the mike, and have the sound come out of the loudspeaker? If not, please explain.

(A. 2) Since R.F. transformers act as a short circuit across the microphone matching transformer, this circuit is not practical. However, by connecting the microphone so as to modulate the output of a tube oscillator, the output of which feeds into the antenna and ground posts of the set, good results may be obtained. In fact, this arrangement is substantially a variation of the modern, A.F. modulated R.F. service oscillator.

A refinement of this idea is now available as a commercial unit, the Shure model 99 Radio-Modulator; the schematic circuit is shown in Fig. Q.201B. This instrument is designed to make any radio set part of a "P.A." system. (This radio-modulator and an A.C.-D.C. ultramidget receiver would make a good portable combination for public address work of light-duty type, such as addressing show-window crowds, etc.—a combination which could be operated on A.C., D.C. or batteries, by using a battery-operated radio-modulator with self-contained power supply.)

This highly-perfected circuit is essentially that of a Hartley oscillator with Heising modulation. To prevent radiation, particularly where the antenna system is multiplexed for the operation of several radio broadcast receivers, the antenna connection is removed from its connection post on the set, only one lead being connected to the set antenna post. (The shielded an-

shop power is A.C., and the set to be tested is designed for D.C.?)

(A. 1) That's an easy one: the hard part is to work it the other way 'round—to test, for instance, an A.C. phono-radio combination in a shop equipped only with a D.C. power system.

To solve the first problem, use either a motor-generator, or some form of converter. Practical converters are of two types, the rotary and the vibrator.

To obtain an A.C. supply in a D.C. district for testing A.C. equipment is not quite so easy: the success of the attempt is partially dependent upon the demands of the A.C. equipment. Thus, it is a fairly simple matter to test a radio receiver designed to operate on a 60 cycle supply, through the use of a motor-generator, or some form of "inverter": but, to obtain exactly, and continuously, the A.C. supply required for good operation of a phonograph unit will require the careful selection of a motor-generator unit.

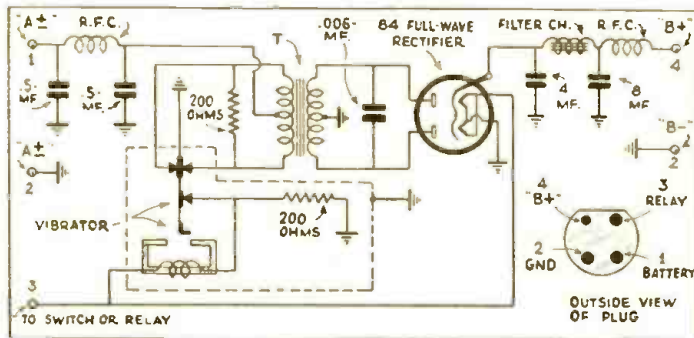

Fig. Q. 201A. Schematic circuit of the model 6F "B" unit. Note the use of full-wave rectification.

CLASS B TRANSFORMERS IN CLASS A¹

(203) Mr. J. Gregorka, Little Falls, N. Y.

(Q. 1) Please advise whether class B, A. F. transformers can be used in a class A prime circuit.

(A. 1) Class B, A.F. transformers may be used in class A prime circuits.

(Q. 2) Has any real, simple material on class B amplification been published in RADIO-CRAFT? If so, when and what information was contained in the article?

(A. 2) One of the first articles to appear in this magazine on class B amplifiers appeared in the July,

1932, issue of RADIO-CRAFT in an article by McMurdo Silver entitled, "Pentode, Class B, or Triode Audio Systems—Which?" This article treated in detail the advantages to be gained by the use of these three methods of amplification. Statistics were given to show the relative sensitivities of the methods when distortion is considered.

The interesting conclusion drawn by Mr. Silver is the fact that by using a new proportion of voltages applied to an output tube, a type of amplification akin to class A prime may be secured that gives large gain with small signals. Now, it should be remembered that in the modern class A prime systems, such as used by Zenith, the grid current is excessive, so that class B input units must be used if distortion is to be avoided.

(Continued on page 40)

SOURCES OF D.C. AND A.C. POWER

(202) Mr. Wilbert L. Misner, Vintondale, Pa.

(Q. 1) There are times when it is necessary to take a radio set to the shop in order to repair it most efficiently. Now, this is all right when a fellow has A.C. in his shop and brings in an A.C. set, but, what is he to do when his

antenna and ground lead cable furnished with this radio-modulator is 50 ft. long.)

The main advantage of this system is that there becomes available, not only the gain of the A.F. system of the radio set, but also, the gain of all the R.F. stages. (Of course, in superheterodyne receivers, the gain in the I.F. circuit is also obtained.)

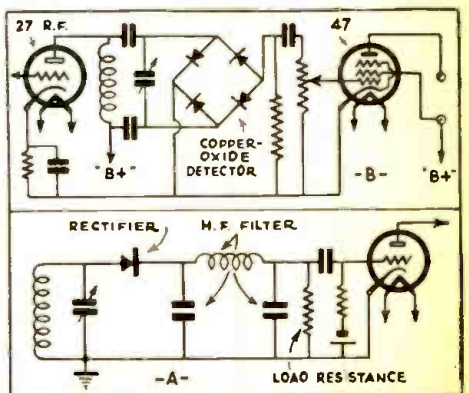
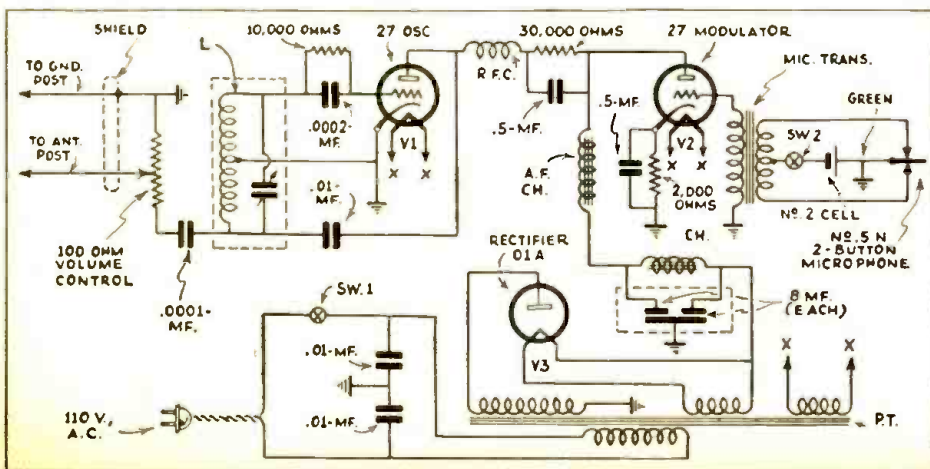

Fig. Q. 200, above: Diagrammatic illustration of the manner in which a copper-oxide rectifier may be used as a detector in a radio receiver.

Fig. Q. 201B, left: Shure model 99 radio modulator.

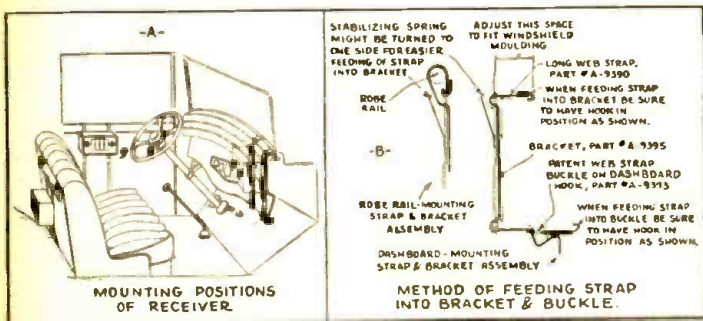

Fig. 1

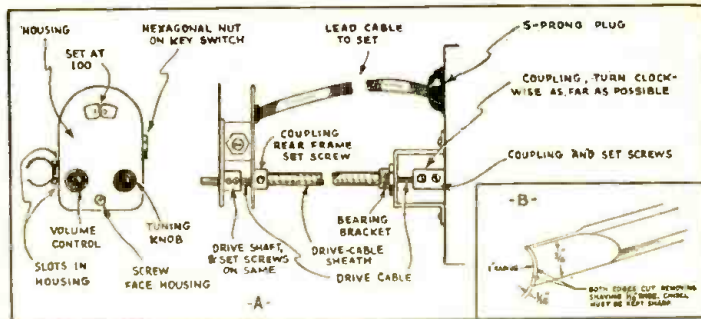

Fig. 2

SERVICING AUTOMOTIVE RADIO SETS

(204) Mr. H. J. Overcamp, Paterson, N. J.

(Q. 1) Are there any data available on the servicing of auto-radio sets? I know that much material has appeared in past issues of this magazine, but is there some sort of compendium?

(A.1) "Automobile Radio and Servicing," by Louis Martin, is, as the sub-title of this 64-page book published by Gernsback Publications, Inc., states, "A complete treatise on the subject covering all phases from installing to servicing and maintenance." However, several car radio set manufacturers are now offering recommendations which, although they are intended for the specific use of technicians who may be called upon to install their particular receiver models, are directly applicable to equipment of different manufacture. Consequently, the writer has compiled some of the more interesting of this useful data, and presents the information with due credit to the individual source.

Thousands and thousands of "A.C.-D.C." sets have been sold, many of them with the recommendation that, through the use of an adapter they could be installed in automobiles and operated directly from a set of "B" batteries or a "B" eliminator, and the car "A" battery, and others without any such additional sales incentive. Into the first class falls the Sentinel model 561 receiver described and illustrated in this issue. The manner of conveniently installing this ultra-midget set is illustrated in Fig. 1. Additional data is given below.

The receiver may be mounted in any convenient place in the automobile such as: (a) the robe rail in back of the front seat; (b) between the dashboard and windshield frame, or (c) on the underside of the dashboard head. It is well to remember that the further the set is from the motor the less the ignition noise is likely to be. The receiver should be so mounted that it does not strike the body through bouncing or road jars as the cabinet may be damaged if the set is permitted to swing freely. The mounting brackets, shown at B, have lugs on both ends which should be hooked between the windshield frame or robe rail or wherever the set is to be mounted, and the bottom lug hooked to some part of the body or body bolts and the slack in the straps taken up by adjusting the adjusting-buckle so that the set is held rigidly in position. The four studs provided should be screwed into the four threaded holes in the back of the chassis. Each of the strap mounting brackets has two holes into which the stud should be inserted and by pulling upward on the straps the stud will be locked into position. Pushing the strap downward will unlock the studs and permit removal of the brackets.

It is very important that a good aerial system be used with these diminutive sets as a small or ineffective aerial will result in poor reception. A simple aerial installation that will give good results can be had by using about 50 ft. of stranded, insulated wire and running the wire under the car, back and forth between the two running boards, using care not to stretch the wire too tightly as the bouncing of the car will break the wire. An aerial in the top of the car and insulated from the body will in most instances be an excellent one. Many of the latest model automobiles are factory equipped with this type aerial. A strap-type or plate-type antenna mounted beneath the automobile will generally be effective. The closer to the ground this type of aerial is permitted to extend the greater its efficiency.

Interference can be minimized to a point where radio reception is not materially impaired but do not expect to absolutely eliminate every noise,

or interference from spark plugs, coils and generator. The location of the aerial will greatly affect the amount of motor interference picked up. The further away from the motor the aerial is located the less the ignition noise will be. If after correct installation of noise suppression accessories, ignition interference is encountered, the following may be of benefit. If the motor interference comes in together with a rather loud station program, insufficient grounding of the motor may be the cause. Bonding the motor to the chassis at several places and shielding the ignition lead from the high-tension coil to the ignition switch may help. A faulty ignition coil and dirty or corroded terminals in the distributor will cause noise. A condenser connected between the hot side of the ammeter and car chassis will in some cases help in reducing the ignition interference. Ignition noises should be distinguished from that of other types of interference. Ignition noises will only be heard when the motor is running. Noises that are apparent only when the car is in motion may be caused by loose connections in headlights, dome lights, or "A" battery or "B" eliminator, or nearby electrical interference such as power lines, street cars, etc. As the "peewee" receiver does not have automatic volume control, more or less fading of the signal will be noticed when the car is in motion, particularly in cities, due to the continual changes of the signal strength caused by shielding from street cars, street car lines, telephone and telegraph lines, steel bridges, trees, geological formations, etc., or when passing under bridges and viaducts. This lack of A.V.C. is a thought to bear in mind when installing the receiver chassis, since placing it in a position conveniently reached by the person who most frequently uses the car, the driver, renders it a simple matter to compensate for major changes in volume by a simple twist of the manual volume control.

While it is possible to use "B" batteries instead of a "B" eliminator, it is not recommended that these be used as the life of the "B" battery will be very limited. However, if "B" batteries are used, it is recommended that only 90 volts of battery be connected to the receiver. (In this instance it may be well to note that special, heavy-duty "B" batteries, especially designed for use in cars, are now available. One manufacturer's product is illustrated and described in this issue. Author.) A further consideration of which the Service Man should take particular note is that neither the "B" batteries or the set should be placed in a position where the heat of the motor (or, when used in the winter, the car heater) can affect these components; the former would have short life due to the increased corrosive effect of the acid and the evaporation of moisture, and the latter would tend to break down due to faults developing in the electrolytic and paper condensers, and the reproducer.

If a "B" eliminator is used, it should be designed to deliver 125 volts at (for the Sentinel set) 60 ma. The eliminator should include a relay: a separate hot "A" lead should be run direct from the "A" battery to the hot "A" lead of the eliminator and a second, separate lead from the hot "A" lead to the receiver. If, instead, a single common "A" lead is used for both the "B" eliminator and set, there is a possibility of noise interference from the eliminator, due to coupling in the lead.

For those universal-current sets not equipped with 6-volt adapters, and which therefore fall into the second class, 6-to-110 volt converter will be required.

At A in Fig. 2 is shown the method of mounting the Pierce Airo DeWald auto-radio remote control unit with respect to the receiver, for best operation of the control; the procedure is ap-

plicable to most sets incorporating a mechanical control cable.

The receiver should be mounted on the rear dash under the cowl, preferably on the right-hand side. Using the template furnished, drill four holes into the rear dash for the receiver mounting. Insert four bolts for the housing and, with the aid of spacers (if required), attach the receiver to this panel. Prior to mounting the remote control to the steering post, remove the screws from the face of the housing and loosen the hexagonal nut on the key switch, permitting the housing to slip off. Slip the drive cable sheath back over the cable, permitting the cable to enter the drive shaft. Tighten the two set screws on the drive shaft coupling only. Now, insert the cable sheath into the coupling on the rear frame, tighten the set screw and replace the housing.

Next, insert each half of the clamp through slots on the left side of the housing, at the same time placing these in position around the steering column. Fasten the clamps by means of a screw, lockwasher and nut, and adjust the drive to the desired position. Turn the coupling, located between the receiver housing and "U" bracket on the left side of the set, clockwise as far as possible; also, set the dial on the remote control at 100.

Then, insert the drive cable and sheath through the bracket-bearing on the receiver housing. The drive cable which extends beyond the sheath should enter the coupling and be locked in position by the set screws. Care must be taken when assembling not to change the setting of the remote control or the tuning condenser. Finally, insert the 5-prong plug, extending from the remote control cable, into the socket on the left-hand side of the housing. The yellow lead is connected to the hot "A" battery terminal; the black lead is connected to any, low-resistance, grounded part of the chassis or, preferably, directly to the grounded terminal of the car battery.

At B in Fig. 2 is illustrated a new automotive-radio tool. After deciding on the location of the "B" supply and radio chassis container cans, for the Ford-Majestic model 114 receiver, it is necessary to cut a hole 6 1/32x9 9/32 in. long, with a 1 1/16-in. radius at each corner. To make these cutouts, drill a hole in each corner of each layout and cut out the center. A chisel sharpened as shown at B has been found to be very effective in making these cut-out in cars having a metal floor. This chisel should be approximately 1/16-in. thick at the cutting edge and should be sharpened as indicated. By following the layout exactly, the resultant hole will be slightly larger than the layout. (This makes a better job than does the usual cold-chisel and hammer procedure.) This is desirable, as it permits an easy installation of the containers. If the floor of the car is constructed of wood, the cutouts are easily effected by using a keyhole saw.

A "B" battery container is furnished with the Franklin model 200 receiver. In mounting this can, be sure that you check underneath the floorboards to see that there are no brake-rods, mufflers, storage batteries or other parts of the car located directly below the space in the floorboards. The correct method for locating the position for the container is to hold it against the floorboards from underneath the car, drilling four small holes up through the floorboards at the four corners of the box, to serve as exact cutting guides. In some cases it will be necessary to fasten braces underneath the floorboards, at the edge of the can, to strengthen the floor of the car, due to the fact that sometimes the location for the battery container necessitates cutting through the whole width of one floor board. Securely wedge or shim the batteries into place.

AT LAST!

WORLD-FAMOUS COYNE TRAINING IN ELECTRICITY Available For HOME STUDY



NOT The Ordinary Correspondence Course

The 1,000 page COYNE Standard Reference Set, with its more than 1500 illustrations, is NOT the usual correspondence course. It is so arranged that, instead of getting one or two lessons a month from which to answer a few simple questions, you get the whole complete volume at once, so that you can refer to advanced sections and different branches of electrical work at will, going ahead as fast or slow as you please. And the book itself is always valuable for constant reference and review.

No Previous Experience Needed To Succeed

Advanced education or previous experience is not needed to make a success of COYNE Electrical Training. Everything is given in simple, easily understood language, illustrated thoroughly by photographs and diagrams. If you can read and understand simple English you can learn all about the operation, care, service, repair, etc., of practical electrical equipment from this great book.

Immediate Profits From This Book!

You will find it possible to learn to do real electrical jobs almost immediately upon receiving your COYNE Standard Reference Set book. There are many excellent opportunities to earn good money from spare time electrical work right in your own neighborhood while you are studying. This is not idle talk—but the actual experience of others no brighter or more able than you. If you have pep and initiative, you ought to be able to make this set pay for itself many times.

The practical, simple, easily understood instruction material that has made COYNE famous for 34 years is NOW—for the first time in history—available for YOU to study AT HOME! Never before has this instruction material been available for any but regularly enrolled resident students and graduates of COYNE. But now, compiled by the entire COYNE staff assisted by many of the world's outstanding electrical firms, this rich store of electrical knowledge is available for you in convenient book form—to study at home.

FREE CONSULTATION SERVICE INCLUDED

Every owner of this wonderful book—The Standard COYNE Reference Set—will be entitled to the privilege of freely consulting with COYNE Expert Instructors in the solution of any electrical problems that may arise in studying and using this home training set during an entire year's time. This feature alone is worth many times the small price of the book... as testified by hundreds of working electricians—who have made use of this unique service.

Here's Why I Am Taking This Step!

It means a great deal to me to break a tradition and change a well-established policy after 34 years. That's what I am doing when I offer COYNE Training to you AT HOME, instead of ONLY here in our great shops. But these are unusual times, and have created unusual conditions. Many ambitious men who would be here at COYNE now—preparing themselves for a useful, profitable life work in electricity—cannot come because of financial difficulties. It is my thought that, by offering this COYNE Training to them for home study at ridiculously low price, they will be able to earn from what they learn, and soon be financially able to come to COYNE later if they decide they still want this superior electrical training that is known the world over for its practicalness and thoroughness. Not that getting this book means the buyer has to come to COYNE. It is simply my hope that the knowledge and earning power gained from this book will inspire you to want the complete training that can come only from attendance at COYNE.



H. C. Lewis, President.

Don't Delay—Get Started NOW!

This big book of more than a thousand pages—cramped full of practical electrical knowledge illustrated by more than 1500 photographs, diagrams, etc., shows you how to do real electrical jobs of every kind from installing switches and wiring houses to connecting, testing, operating and repairing A. C. and D. C. motors, controllers, generators, and switchboards. Get it AT ONCE—you'll be delighted with the ease and quickness with which you learn and can get to making real money out of spare time electrical work. Send your order on the coupon NOW!

2⁰⁰
WITH ORDER
\$2 A Month

Until full price of \$12 is paid.
Or \$9.75 cash in advance.

COYNE ELECTRICAL SCHOOLS

500 S. Paulina Street,
Dept. B3-85
CHICAGO, ILL.

Enclosed herewith find \$2.00 (cash, check or money order) for which I agree to pay \$2 a month, until the total price of \$12.00 is paid. (If you prefer to pay all cash, remit only \$9.75 with this coupon in complete payments.)

NAME _____
ADDRESS _____
TOWN _____
STATE _____

A NEW REVOLUTIONARY Static ELIMINATOR



Illustration shows eliminator with leads and plug attachments

Here at last is a device made to eliminate completely man-made static, the type of noises that so often causes discomfort to radio listeners. Quickly it reduces to a minimum, disturbances caused by electrical appliances and aerials of all descriptions, and brings in reception with clear, and excellent results. Can be connected in five minutes. Supplied with 75 feet of shielded lead-in wire.

Service Men and Dealers add this money-making radio device to your line—install the Dumont Eliminator in every home where you call to service the set. A lifetime of service is guaranteed for every Dumont Eliminator.

SERVICEMEN AND DEALERS! Get our catalog and prices on complete line of replacement condensers, Electrolytic and Paper. They are "Best by Test." Jobbers and representatives territory open. Write today.

Clip—Mail Coupon Today!

DUMONT ELECTRIC CO., Inc., Dept. RC-7
453 Broome Street, New York, N. Y.

Enclosed herewith you will find check or money order for \$2.85. (Regular List Price, \$5.00), for which you are to send no postage prepaid, one Dumont Static Eliminator, with complete instructions for operating.

Name:
Address:
City: State:

New LYNCH RESISTOMETER FREE with 8 Handipaks



The New LYNCH Resistometer, the handiest service unit ever devised, can now be had FREE with LYNCH Handipaks. This is the most popular and practical service package ever offered.

Now—in a jiffy—you can measure accurately the resistance value you to replace—with the new LYNCH Resistometer.

Any value is obtained by the handy combinations made possible by LYNCH Handipaks. Each Handipak contains ten assorted One or Two Watt Resistors of the Metallized Type.

Complete Resistometer and four No. 1; three No. 2 and one No. 3 Handipaks, to Dealers and Servicemen: (List Price \$21.00) Your Cost.....\$10.00 Net.

Free Descriptive Folder Upon Request

LYNCH MANUFACTURING CO., Inc.
51 Vesey Street, New York, N.Y.

A 9-TUBE SUPERHETERODYNE

(Continued from page 23)

is operated on D.C. one of the voltage-doubling condensers, C13, is shorted out of the circuit, and all the tubes from V1 up to V7, inclusive, as well as the speaker field, are placed across the 110 V. line; thus, the rectifiers can be used to filter out D.C. commutator ripple, etc.

For 110 V. operation the filaments are wired in the alphabetical sequence of A to K, and connected to the power line at these lettered points, as shown in Fig. 1.

Since the total power consumption of this receiver at 110 volts is about 55 W. on D.C. and about 60 W. on A.C., for 220 V. A.C. or D.C. operation, it is but necessary to place a 75 W. resistor of 280 ohms in series with the line cord.

For 6 V. operation, all the filaments should be connected in parallel and type 41 or 42 tubes should be employed instead of the type 18. For 32 V. operation, tubes V1 to V5 should all be left connected in series, and paralleled with the second group of tubes in series, consisting of the two type 18 and one type 37 (V5). Of course "B" batteries should be employed to obtain the remaining voltages, when the filaments are battery operated.

As a final check on the completed receiver the following tabulation is furnished. These tube operating voltage values will vary slightly with individual conditions of line voltage, tubes and apparatus used. Values are for R1 at minimum, and with no signal.

Tube Type	Line Potential, 110 V., A.C.				Plate Ma.
	Plate Volts	Cath. Volts	S.-G. Volts	Ma.	
V1	115	90	3	3	3
V2*	115	60	2	5	5
V3	115	90	3	3	3
V4	15	...	3
V5	110	...	4	...	6
V6, V7	210	220	30	15	15
Line Potential, 110 V., D.C.					
V1	100	3	75	2.5	2.5
V2*	100	4	60	1.5	1.5
V3	100	3	75	2.5	2.5
V4	14	2.5	2.5
V5	95	5.5	...	3	3
V6, V7	95	9	100	20	20

*Anode-grid potential, 115 V. on A.C. and 100 V. on D.C. The control-grid voltage of all tubes is zero. The voltage of one set of cathodes of V8, V9 is 120, and the other is 240, on A.C.; on D.C. both sets measure 110 V.

List of Parts

One 4-gang condenser, superheterodyne type, 350 mmf., Cg1, g2, g3, g4;

- One Remington filter choke, 200 ohms, 125 ma., 30 hy., Ch;
- One band-pass antenna coil and shield, L1;
- One even-gain interstage R.F. coil and shield, L2;
- One 175 kc., I.F. transformer and oscillator coil composite unit, with shield, L3;
- One k.c., I.F. transformer unit, closely-coupled, L4;
- One Remington push-pull input transformer, type 6153, T;
- One 11 in. electrodynamic speaker with 4,000 ohm field coil and push-pull pentode output transformer;
- One mica condenser, .006-mf., C1;
- One Coast-To-Coast 1 mf., 200-V. paper condenser, type 4227A, C2;
- Five Coast-To-Coast .1-mf., 200-V. paper condensers, type 4227, C3, C4, C5, C10, C11;
- One mica condenser, 300 mmf., C6;
- One mica condenser, .001-mf., C7;
- One Coast-To-Coast cartridge condenser, .02-mf., 200 V., type 4225a, C8;
- One dry electrolytic condenser, 5 mf., 35 V., C9;
- One dry electrolytic triple condenser unit having a special dual 16 mf., 175 V. section and an 8 mf., 400 V. section, C12, C13, C14;
- One Coast-To-Coast cartridge condenser, .05-mf., 200 V., type 4225a, C15;
- One Coast-To-Coast multiple-condenser tone control, type 5515a, C17;
- One Claroast 10,000-ohm potentiometer with special taper, 400 ohm minimum resistance and switch Sw1, R1;
- Three Lynch resistors, 250,000 ohms, 1/2-W., R6, R7, R2;
- One Lynch resistor, 300 ohms, 1/2-W., R3;
- One Lynch resistor, 10,000 ohms, 1/2-W., R4;
- Two Lynch resistors, 500,000 ohms, 1/2-W., R5, R9;
- One Lynch resistor, 2,700 ohms, 1/2-W., R8;
- One Lynch resistor, 10,000 ohms, 2-W., R10;
- One Lynch resistor, 3,000 ohms, 1-W., R11;
- One Lynch resistor, 210 ohms, 2-W., R12;
- One Coast-To-Coast resistor, 20 ohms, 2-W., R13;
- One twin-post connector block for phonograph pickup, etc., J1;
- Two miniature 5-prong wafer sockets, S5, S10;
- Seven miniature 6-prong wafer sockets, S1, S3, S4, S6, S7, S8, S9;
- One miniature Special 7-prong wafer socket, S2;
- One Coast-To-Coast combination D.P.D.T. and D.P.S.T. jack switch, Sw2;
- One ghost-light tuning dial and 6 V. pilot light;
- One Coast-To-Coast drilled metal chassis, type E20;
- Miscellaneous hardware, knobs, wire, cables and plugs, 1 A. fuse, etc.

COPPER-OXIDE RECTIFIERS

(Continued from page 19)

and, also, by the absolute value of current flowing. Fig. 5 shows this characteristic. This again results in a complex situation involving temperature, current, and efficiency; and a simultaneous study of all of these variables is the only means by which errors from temperature variations can be minimized. For example, with certain values of current flowing, the efficiency of an uncompensated rectifier instrument may drop from 80% to 75% during a 40° C. temperature rise. This would result in lowering the calibration of the instrument 6% at the higher temperature if no steps were taken to secure temperature compensation.

Summary

The majority of the above discussed errors, characteristic of rectifier instruments, can be minimized by careful design and by taking advantage of the opposite effects of certain errors. However, it is important that the instrument be properly designed to operate with the copper-oxide rectifier. It is therefore, not advisable to try to apply a copper-oxide rectifier to an existing d'Arsonval instrument which has not been designed for this application unless changes are made to provide proper moving coil resistance, temperature compensation, and swamping resistance. If the errors are properly cared for in

the design of a complete rectifier instrument, reasonable accuracy can be obtained.

The chief advantage of a rectifier instrument is in its high sensitivity. By use of the rectifier principle, alternating-current voltmeters may be made with a very high resistance per volt. Standard voltmeters are available in ratings as low as 4 volts with a sensitivity of 1,000 ohms per volt, 1.5 volts with 2,000 ohms per volt, and even .5-volt with 5,000 ohms per volt. Below four volts, rectifier voltmeters should have a resistance of 2,000 ohms and, better still, 5,000 ohms per volt, in order to properly compensate for the errors discussed above. Milliammeters and microammeters of low ratings are also available.

Rectifier instruments are rapidly finding their place in the radio field for the measurement of such quantities as output of amplifiers and oscillators and power level indicators. The user of these instruments should bear their characteristics in mind, particularly their accuracy, when used under various conditions. Rectifier instruments are a valuable contribution to the science of radio and they are continually finding new uses in this rapidly advancing art. Possibly the further developments in research and engineering on these instruments will tend to minimize their present errors and make them still more useful.

READERS DEPARTMENT

(Continued from page 37)

A "REAL ESTATE" RADIO SHOP

Editor, RADIO-CRAFT:
In your November issue, you show a photo of a taxi-stand radio shop. Well, for your Western readers, I am enclosing a view, Fig. B, of my "Real Estate" office radio shop. Tell the boys to come on and let's see what their shops look like.

**GEORGE SMITH,
Smithy's Radio Shop,
1112 1/2 S. Main St., Los Angeles, Calif.**

(First it was the taxi-stand radio shop; now, it's the real estate office radio shop; what next?—*Technical Editor.*)

FROM WYOMING

Editor, RADIO-CRAFT:
It seems as though every state in the Union gets a word in for RADIO-CRAFT except Wyoming. Well here's one from the little town of Lusk, Wyo.

I operate an independent service shop and do real well. I'm always looking for service short cuts and many items in the columns of RADIO-CRAFT fill the bill. I have a tip that contains a real surprise for any one who tries it. Remodeling old sets is in order these days, especially converting old sets for the 2 V. tubes.

Recently, I converted an Atwater Kent model 67. As every Service Man knows, this is a 7-tube set utilizing a speaker whose voice coil connects to an output transformer. Of course, for 2 V. operation we discard this speaker for a magnetic unit. However, the ordinary magnetic speaker will not have enough volume when connected to the voice-coil-matching winding of the output transformer (the two large prongs in the speaker socket connect to this secondary).

Clip the two wires leading from the output transformer to the two large prongs near the transformer, splice a piece of wire on each lead, and connect one lead directly to the plate of one power tube and the other lead directly to the plate of the other power tube. Leave the primary of the output transformer connected to the plates (as it was) in order to furnish a load in the output circuit of the power tubes.

I used 31's in the output stage, and 135 volts of "B" battery.

We get enough daytime volume to spare, and the tone is as clear as a bell. The only other changes were to short out the filament resistors to the screen-grid tubes. The "B" battery drain is 12 to 14 ma.; "A" battery drain, .63-amp. (safe for air-cell).

**RAY L. WONDERLY,
Box 531, Lusk, Wyo.**

1933 SERVICE IN THE "STICKS"

Editor, RADIO-CRAFT:
Received my first issue of RADIO-CRAFT O. K. Now comes the important question: What will the rural radio Service Man have to buy to beat the many modern and different types of radio equipment found throughout the country?

Some of the leading manufacturers no longer furnish voltage charts, but add the following to their manuals: "Voltage socket readings are not to be relied upon." What will we do? The radio Service Man is called upon to fix a 1933, 7-tube midget with his 1932 tester and about ten adapters hanging out of his pockets; the owner expects modern service in these modern times and the coming year will see many a rural Service Man "stuck." Last year we could use a set of tubes from our kit of "standards," fill out a voltage reading chart, and then decide if we had to take the chassis home; but now, the owner looks at you if you tell him you will have to take his modern radio to the shop, and you are lucky if a kick does not land on you—frequency! There are not many rural Service Men of good standing who can afford a \$250 test kit to carry around on the rough country roads.

I am sure that a good article written by an authority, on radio servicing and its problems presented to the rural Service Man would be welcomed by many of your readers.

**ROBERT ROGERS,
Arundel, Que., Canada.**

(O. K. Rogers—you've sold us the idea.)

The New
Westinghouse Instruments
meet all radio requirements

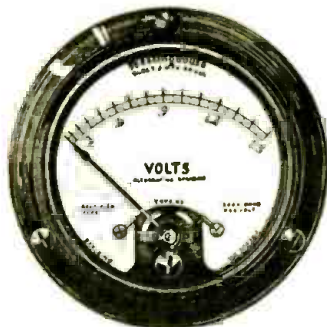

In the new line of panel instruments, types MX and NX, are ratings to meet every need of the radio experimenter, engineer, or service man. Rectifier voltmeters with resistances from 1000 up to 10,000 ohms per volt are standard. Rectifier milliammeters and micro-ammeters are included—also many ratings of radio frequency ammeters and milliammeters.

New ideas in design and construction are used. Permanent magnets of high grade tungsten or cobalt steel are welded to the soft iron pole pieces in accurately aligned



fixtures. This results in permanent accuracy and uniform scale spacing.

The iron core, movement, and jeweled bearings are mounted on a die-cast single frame for easy removal of the moving element as a unit.

The matte silver finish dials are made

of metal in order to prevent warping.

The 2 1/4-inch type MX is mounted in the panel with a clamp, and the 3 1/2-inch type NX with three bolts through the flange. Moldarta cases are used.

A new catalog on MX and NX instruments is now available. Request your copy from—

WESTINGHOUSE ELECTRIC & MANUFACTURING CO.
ROOM 2-N T 79516 EAST PITTSBURGH, PA.

New SUPERHETERODYNE AC-DC UNIVERSAL RECEIVERS
OPERATE from 6, 32, 110, and 220 VOLTS AC or DC
EMPLOY DYNAMIC SPEAKERS and VOLTAGE DOUBLING RECTIFIERS

5 TUBE MODEL Available in ASSEMBLED KIT FORM of FACTORY WIRED **9 TUBE MODEL**

May be installed anywhere in AUTOMOBILES, MOTORBOATS, HOSPITALS, BEDROOMS, HOTELS, CAMPS, DENS

Produces 8 WATTS UNDISTORTED POWER OUTPUT EMPLOYS 11 inch. WRIGHT-DE COSTER DYNAMIC SPEAKER

3 STAGE PUSH PULL AMPLIFICATION

10's COMPLETE KIT **19's COMPLETE KIT**

1933 SERVICE IN THE "STICKS"

FREE Write TO-DAY FOR THIS VALUABLE RADIO TREATISE

COAST-TO-COAST RADIO ACCESSORY CATALOG

YOUR COMPLETE SATISFACTION GUARANTEED

YOUR COMPLETE SATISFACTION GUARANTEED

12 in. long, 10 in. wide, 8 in. tall. Nothing that will add to its value or life has been omitted from this new ultra-sensitive **NEW TUBE SUPERHETERODYNE TRANSFORMERLESS RECEIVER** (Completely described in this issue). Its circuit is inductively tuned for keen sensitivity. (3000-4000 mile reception, in completely reported). Produces **8 WATTS** of undistorted audio output employing **THREE STAGES of PUSH PULL (CLASS "A" AMPLIFICATION)** operating as 11 in. **Wright De Coster Dynamic Speaker**—a convenient "PHONE-MIKE" JACK makes this versatile receiver suitable for use as a veritable **PUBLIC ADDRESS APPLIANCE**. Incorporates quick **AUTOMATIC VOLUME CONTROL**—**FULL RANGE TONE CONTROL**—**TWO VOLTAGE DOUBLING RECTIFIERS** for double volume on AC—**POT LIGHT TUNING**—**INTER-CHANNEL NOISE SUPPRESSION**—this astonishing "sequencing" feature cuts out all background noise and sets a **STATIC REJECTOR**; Employs a **High-Gain Pre-Selector Band-Pass Filter**, an **EMISSION-VALVE MODULATOR (847)** and a **HIGH GAIN I. F. AMPLIFIER**.

Assembled Kit (Less Cabinet) \$19.50
Tubes, and Dynamic Speaker.....
Wired, Ready for Use.....**\$26.50**
11 inch Wright DeCoster Dynamic Speaker.....**7.35**
Matched Set of 9 Tubes.....**\$7.98**

CABINET ALONE \$19.50

10's \$10.75
Fully Assembled Kit and Dynamic Speaker Less Tubes.....
Factory Wired—Ready for Immediate Use.....
Set of Five Matched Tubes.....
Walnut Cabinet (Illustrated).....

12.75
3.95
1.95

COAST-TO-COAST RADIO-CORPORATION
123 R. WEST 17TH STREET NEW YORK, N. Y.

AUTO ANTENNAS

The new antenna will positively increase the pickup and performance of any auto radio.

Easily installed in any automobile either sedan—coupe—roadster—or cabriolet.



TWO TYPES TO CHOOSE FROM

RUNNING BOARD (54x5 1/2)		ROOF TYPE (36x26)	
LOTS—1.....	\$1.95 List	LOTS—1.....	\$4.50 List
10.....	\$1.15 Net	10.....	\$2.70 Net
25.....	1.05 Net	25.....	2.40 Net
	.95 Net		2.25 Net

CASH WITH ORDER OR C.O.O.

IMMEDIATE SHIPMENTS
WIRE OR AIRMAIL ORDER TODAY
Agents and Distributors Wanted

M & H MANUFACTURING CO.
112 Canal St. Boston, Mass.

PORTABLE Public Address SYSTEMS

Profits this summer are to be made from installation of Portable Public Address Systems. They are needed in churches, auditoriums, restaurants, stores, outdoor picnic grounds, etc. For every need, MILES can supply Power Amplifying Equipment. Complete equipment for automobiles, A. C. or D. C. line, "B" current supply and Universal A. C.-D. C. receivers. Out-in in watts from 1 1/4 to 500.

SPECIAL—Complete A.C.-D.C. Junior Portable Public Address System—Net price to dealers and service men, \$21.00 complete.

Send us your specifications for Power Amplifier Systems for automobiles. Every requirement can be satisfactorily filled.

Miles manufactures—Portable Public Address Systems; Exponential Horns; Trumpets; Basses; Labels and Broadcast "Mikes"; Power Amplifiers; "Concerto blones"; "Announcings" and "Detectophones" Systems; Microphone Stands; Transformers; Photo Electric Relays and everything in the Sound Equipment field.

Write for interesting literature describing complete line of Miles Products.

MILES REPRODUCER COMPANY
244 W. 23 St. Dept. RC New York, N. Y.

USE OHIOHM SPARK SUPPRESSOR SETS

for eliminating Ignition Interference on Automobile Radios

For 4, 6 and 8 cylinder cars. Furnished complete with condenser and necessary spark suppressors. Lasts the life of the car. Special non-shorting, and temperature and vibration resisting features. Cash in on this growing market.

THE OHIO CARBON CO.
Cleveland, Ohio

RADIO SERVICE MEN

Be sure to read the announcement on Page 48 of this issue, which tells about the new ORSMA BULLETIN. It is the most up-to-the-minute news tabloid for all radio Service Men.

LOCATING AND CORRECTING PICKUP FAULTS

(Continued from page 31)

the needle on the record will be taken into consideration while the revolutions are being counted. The standard records turn at 78 revolutions per minute. On later phonograph combinations, there are two speeds provided: one for the standard record speed, and a slower speed of 33 1/2 revolutions per minute for the long-playing records. The speed control mechanism is provided with a control lever to give either of these two speeds. It might be well to mention the fact that the needles for the long-playing records are specially designed for use only on these records and cannot be used on the standard records.

Quite often the speed adjustment alone will not remedy the distortion. It is then generally possible, by listening carefully to the sound coming from the speaker, to localize the source of the distortion. First, ascertain whether or not the high and the low notes are being heard, if conspicuous by their absence, it is generally due to the armature being off center.

If there is a rattle on certain notes and blasting on the low notes, the trouble may be generally traced to worn out, or deteriorated, rubber damping blocks.

If a vibrating and crackling noise is heard while the record is being played, it may be mainly due to the fact that the base of the pickup, near where the needle is inserted, is magnetic, and attracts small particles of iron. Sharp, cracking sounds, not unlike static discharges, very often may be traced to loose connections in the pickup unit.

Weak magnets will also cause low reception and distortion: although it is not probable that you will meet with this condition. It is merely mentioned here for the simple reason that we have had cases where some of our customers had been tampering with the pickup unit, and in removing the magnet, did not place a keeper across the poles.

Before going into details concerning the proper adjustment of the armature, replacement of the rubber dampers, and removal of iron particles, a brief discussion of the armature and the rubber damping blocks is in order. In all present-day pickup units it has been found necessary to use some sort of damping on the vibrating armature. Naturally, everything has a natural, or inherent, period of vibration, and if this vibration of the armature is not stopped, or damped, in some way, it would hit the pole pieces and thus cause distortion. The exact methods used to overcome this tendency to vibrate varies, to some extent, in the different makes of pickup units. In general, this damping is accomplished by mounting pieces of soft rubber tightly between the pivot supports, as well as placing a rubber damping block between the pole pieces. Thus, the armature is left free to vibrate between the pole pieces, but is damped by the rubber mounting at its pivot. As with all rubber appliances the best service is obtained when used frequently. If the pickup is used infrequently, the rubber damping blocks and rubber pivot supports becomes hard and unpliant, and this fact usually causes the armature to move to one side, where it does not move freely. There may be other reasons, of course, such as having the pickup unit repeatedly left to rest on the needle or on top of the record, instead of letting it hang free on its proper support after each record has been played.

It might be of interest to know that there is a method which does not use rubber for damping. In this particular model a specially compounded oil is used instead of rubber, for damping purposes. However, it is safe to state that most of the present-day receivers employ the rubber damping method in their pickup units.

Now let us check up on our results obtained from testing the pickup unit by the sound method. If the test indicated that the armature was improperly centered, then this part must be adjusted. The sequence of disassembling the necessary parts for making this adjustment will differ according to the various types and models. However, certain general requisites apply to all pickup units. Remove the outer cover case by removing the cover screws and the needle holder screw. Mark the magnet pole pieces and the magnet with a red crayon pencil, so that when they are replaced, they will be in their original position. Remove the magnet, and place a piece of soft iron across the poles. Failure to observe this precaution will result in a

loss of magneto-motive force which will impair the sensitivity of the pickup unit. Loosen the two round-headed screws in the armature adjusting plate with a small screw driver. The small piece of metal, holding the damping block, should now be moved until the armature is properly centered between the pole pieces. The armature should be held in the exact center of the magnetic field—exactly halfway between the magnet blocks. Judging the center by eye is, in many cases, sufficiently accurate for this adjustment. When certain that the armature is properly centered, replace all parts of the pickup assembly. It should be noted here that, in a good many cases, on certain models, it will not be necessary to remove the magnet and pole pieces to make this adjustment.

If the armature is found to be rusty, a replacement is recommended; but if a new part cannot be obtained quickly, a temporary repair can be performed by scraping off all the rust and rubbing all surfaces with very fine emery cloth. (Do not coat the surfaces with oil to keep it from rusting again, as oil has a deteriorating effect on the rubber dampers.)

To test the armature for centering, the cover plate should be replaced and the instrument turned on; then, while playing a record with the volume control turned on full, lift the pickup unit from the record and move the finger across the needle point, both to the right and to the left. The same sound should now be heard in the speaker, regardless of the direction in which the finger is moved. If the sound is not the same, but weak on one side and strong on the other, then determine which side gives you the weakest reception. If the sound is weakest when moving the finger to the right, the left adjustment screw should be loosened and the rubber pivot support, or adjusting plate, forced over nearer to the armature. If the sound is weaker when moving the finger to the left, the right-hand screw should be loosened and the rubber pivot support, or the adjusting plate, forced nearer the armature. It is advisable always to make the above-mentioned test first, after the turntable speed has been checked, and adjusted, before any attempts are made to replace the rubber padding, as in a good many cases this is the only adjustment necessary.

If our test indicates that the trouble is due to faults in the rubber dampers, then these pads should be carefully inspected.

If badly deteriorated or hard, they should be replaced. The old rubber should first be completely removed by scraping the parts clean with a knife. Specially made rubber pads may be procured from the manufacturer of the particular pickup unit that you are working on. If such a set of rubber pads are hard to obtain, any first-class, good, live rubber—such as part of an automobile inner tube—will do very nicely for the damping block between the pole pieces, and the thin portion of a baby's rubber nipple may be used by cutting out two strips to act as rubber pivot supports. The exact size of the rubber pads required may easily be determined by carefully noting the size of the old rubber pads and then you can make exact duplicates.

The same general rules for disassembling the pickup unit, as previously described for the armature adjustment, should be followed when replacing the rubber dampers. After the magnet, pole pieces, coil, and the armature have been disassembled, all metal parts should be cleaned free from all accumulations of dust and grit; place the new rubber pivot supports in their proper place; and reassemble the pole pieces, the coil, and the new rubber damping block between the pole pieces. Now center the armature and tighten up the screws in the adjusting plate. The next step requires some sort of a clamping device, such as a small vice or a "C" clamp. After the assembly has been replaced on the pickup arm, and you are sure that the magnet poles are against the proper pole pieces, the assembly should be placed in the clamping device for the proper tightening of the pole pieces. The proper amount of pressure to be applied depends on the type of unit you are working on. When working on RCA, G. E. and RCA Victor pickup units, the use of clearance tool will aid greatly in making proper adjustments of the pole pieces. This gauge may be constructed of metal by making one as per the detail shown in Fig. 1C. The

cut out portion slips over the coil, and the two legs slip in between the pole pieces. After the pole pieces have been clamped together, the bolts holding these pieces should be tightened up. Then remove the pickup arm from the clamping device and take out the gauge. The pickup is now reassembled and the cover plate replaced. Before this is done, make sure that the magnet clamp is in its proper place. If the clamp is not in its proper place, it may force the front cover to one side. If this should happen, it will, in all probability, touch the needle-holder screw, and this, in turn, will produce a rattling noise in the speaker.

In removing the pickup assembly from the motorboard, you may be tempted to loosen the two pivoted set screws which are located on each side of the pickup arm just above the top of the base. The advice is: "Don't do it!" The proper method is to disconnect the two output wires under the motor board, then remove the wood screw holding the base in place, and lift the whole assembly off the board. The reason for doing it this way is to avoid tam-

pering with the set screws which are held in place inside of the arm with lock nuts. While working on this part of the unit, the lubrication between the pickup arm and the base should be checked over. If the bearing surfaces appear to be dry, a small amount of vaseline should be applied so as to insure free motion of the arm.

Particles of iron found at the base of the pickup unit can be removed with a toothpick, or still better with a vacuum cleaner.

The radio phonograph transfer switch should always be inspected, and the contacts kept clean, although there is nothing to be gained by excessive filing and cleaning. In some cases, it might be found necessary to bend the spring contacts to insure better compression, since any imperfect contact will materially interfere with good record reproduction.

Very little trouble has been encountered with the motors. In most cases when the motor has a tendency to stall or lose power, all that is necessary is to apply a little oil to the bearings.

THE "FIND-ALL" AUTO RECEIVER

(Continued from page 25)

Two Truvolt wire-wound 350-ohm pigtail resistors, type PG350. (7), (18);
 One Truvolt 1,000-ohm flexible resistor, type 2GB1000. (31);
 One Truvolt 2,000-ohm flexible resistor, type 2GB2000. (24);
 One Aerovox .0005-mf. mica condenser, type 1467. (23);
 Two Aerovox .01-mf. cartridge condensers, type 281. (25), (28);
 Five Aerovox .1-mf. cartridge condensers, type 281. (4), (8), (14), (15), (19);
 One Aerovox .25-mf. cartridge condenser, type 281. (3);
 One Aerovox .5-mf. cartridge condenser, type 281. (32);
 One I.R.C. 30,000-ohm, ½ watt, metallized resistor, type F-½. (6);
 Three I.R.C. 250,000-ohm, ½ watt, metallized resistors, type F-½. (25A), (27), (29);
 Two I.R.C. 500,000 ohm, ½ watt, metallized resistor, type F-½. (2), (21);
 One Amperite, No. 16A. (39);
 Two Acratess 5-prong wafer-type sockets, type 4063, (9), (17);
 Three Acratess 6-prong wafer-type sockets, type 6934. (26), (30), (31);
 One Acratess 5-inch dynamic speaker with push-pull output transformer, having primary of

7,000 ohms, total impedance to match plate-to-plate impedance of 79 tube, six volt speaker field for operation from car storage battery. (35), (36);
 One Acratess push-pull input transformer, 1 to ½ ratio,—primary to secondary. (33);
 Five Acratess screen-grid clips, with leads, type 3892;
 One ¼-ampere automobile type fuse in special retainer. (37);
 One roll of solid core hook-up wire;
 One shielded auto radio "A" cable.
 One shielded auto radio "B" cable.
 One metal chassis, 9¼ inches long x 4½ inches deep x 1½ inches high;
 One piece of No. 18 D.C.C. wire, 1¼-inches long, wound over with about 13 turns of No. 18 D.C.C. wire, closely wound, (11);
 One I.R.C. motor radio suppressor kit, type M-4, 6, or 8;
 One metal cabinet 9½ inches long x 4½ inches wide x 6½ inches high;
 Two type 44 super control R. F. pentode tubes, (9), (17);
 One type 85, duplex-diode triode. (26);
 One type 89 tube. (30);
 One type 79 twin amplifier tube. (34);
 Three 45-volt "B" batteries, No. 6905, or Acratess auto "B" eliminator No. 498.

HOW TO MAKE A CUTTING HEAD

(Continued from page 29)

The pivots of the pivot arm must be sharp and in perfect line. Unless you are experienced, the pivots and the vee groove in which they rest had best be fitted by a jeweler. I was charged thirty-five cents by a local watchmaker for this job.

The two screws with the soft rubber washers under their heads, shown at D, are now drawn up so as to hold the armature in the exact center of the space between the pole shoes. I have found that the best way to make this adjustment is to connect the cutting head to the radio set in place of the speaker voice coil and tune in a loud station. To adjust the armature place the unit on a board or on top of the radio cabinet, which will act as a sounding board. Now adjust the two screws until the voice and music come in clearly.

When used as a cutting head, considerable weight is required to properly record on the blanks. I have found that the proportions shown at I are best suited. Also, of all the blanks which I have tried, the composition pre-grooved ones give, by far, the best results. The regular needles supplied with them are the best to use.

The sketches at K and J show a type of support that may be used to mount the unit, although other types may be used. The only vital thing is to see that the unit moves with perfect freedom and with no lost motion. The cutting head should be set at an angle of about fifteen degrees to the plane of the record.

The support arm is of brass fixture tube—shown at F—and is split the full length on

the bottom side. The arm, shown at H, joining the head to the support arm is made of soft aluminum, one-quarter inch thick. The counter weight, shown at G, is of soft lead and is placed flush with the back end of the support arm. This not only acts as a counter weight, but also damps out vibration, which otherwise might induce resonance.

The yoke, at A, supporting the pivot arm, is made from a soft brass plate one-eighth inch thick. The slots in the ends fit under the screws which hold the pole shoes to the magnet.

The vee slot in the bottom of the yoke must be in the exact center and parallel to the sides of the yoke. It must be small, sharp and clean. It is advisable to have a watchmaker cut this slot.

The pivot arm at C is approximately the shape shown. It also is made of soft brass and as light as consistent with strength. It is the only hard part to make and requires considerable patience. At D, I silver soldered the staff to the base, at B, thus saving considerable filing, that would be necessary when making it from a solid piece.

The soft rubber washers, shown at D, which go under the screw heads holding the pivot arm were cut from a piece of automobile tire tread.

One may save a lot of work in making the knife edge on the pivot arm by threading through two, six-thirty-two screws and dressing to a sharp edge, care being taken to keep the edges in line. This is clearly shown at E.



Put No. 711
 on Your
 Payroll!

Readrite
 TESTER
 No. 711
 Only \$22.50
 Net to Dealers
 (List \$37.50)

"A Remarkable Instrument At a Remarkable Price"

No matter how many testers you now have, you can afford to put No. 711 on your payroll because it brings in more money with less effort . . . enables you to do a quicker, better testing job!

New, Improved Features

Readrite Tester No. 711 is similar to the famous Readrite No. 710, but better. It is equipped with the new Triplett D'Arsonval Voltmeter, having 1000 ohms per volt resistance.

It is equipped with a practical selector switch for checking all parts of the tube circuit by connecting to the set sockets. The readings are 0-15-50-300-000 volts which cover a complete range for testing control grid, screen grid, cathode and plate voltages. Plate current, filament volts, line and power supply volts are also measured.

Contains new wiring and socket for taking care of new small 7-prong tube as well as larger 7-prong tube. It is equipped with a small diameter plug-adaptor for testing in new sockets. Try this amazing tester one day and you'll wonder how you ever got along without it.

Your Jobber Can Supply You

Your jobber can supply you at the dealer's net price of \$22.50. Send coupon for more details.

READRITE METER WORKS
 62 College Ave. Bluffton, Ohio

MAIL COUPON NOW

Readrite Meter Works,
 62 College Ave., Bluffton, Ohio

Gentlemen:

Please send me information about Readrite No. 711 Tester. Also catalog of other servicing instruments.

Name.....

Street Address.....

City..... State.....

Test All the NEW Tubes with This New and IMPROVED Instrument

The E 34 TUBE CHECKER

Tests all 4, 5, 6 and 7 Prong Tubes including the new 15 and 25 volt series. Gives short test; Grid Change Test; Oscillation Test and Total Filament Emission Test—Provision made for future type tubes—voltage regulation 90-130 volts—top with handle provided.

SOLD ON TEN DAYS TRIAL—MONEY REFUNDED IF NOT SATISFACTORY.

E 34 with 3 1/4" D'Arsonval Meter.....\$21.50

E 33 A. same but with vane type meter\$17.80

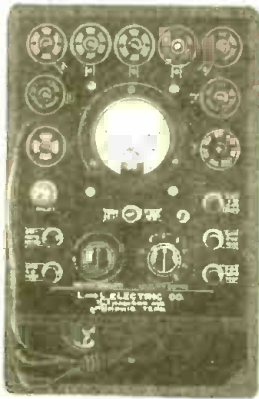

Circular on request

L & L ELECTRIC COMPANY

336 Madison Ave. Dept. 2-A Memphis, Tenn.

CONCOURSE CONDENSERS

highest quality for lowest cost
Every Type of
Dry Electrolytic
and
Wax Paper
Condenser
All Capacities
and Voltages

To fill every Serviceman's requirements

Send in your request for our complete descriptive catalogue

CONCOURSE
ELECTRIC CO. INC.

389-409 Wales Ave., N. Y. City

INFINITE VARIETY & VALUES

FREE!

Our new 108 page Catalog is just off the press. Use it as your guide for buying every radio part you want at the **LOWEST PRICE OBTAINABLE** anywhere. **SERVICEMEN AND DEALERS** will find this catalog a priceless directory for their every need. Every item advertised is carried in stock, thus assuring you **PROMPT DELIVERY.**

SEND FOR YOUR COPY TODAY

TRY-MO RADIO CO., INC.

DEPT. C7, 85 CORTLANDT ST., NEW YORK

Radio Operating—Radio Servicing

Prepare for the new Government Radio Operating license examinations: Radio Operator, Marine and Broadcasting. Also radio Amateur, Telegraph and Telephone. Resident courses. Write for booklet.

"Opportunities in Radio"

WEST SIDE Y M C A TRADE & TECHNICAL SCHOOLS

7 West 63rd Street New York City

A SET-TESTER ADAPTER

(Continued from page 21)

the external meter into the voltmeter binding posts of the analyzer, binding post V, and insert the other two ends into the 250 V., D.C. range of the meter.

We are now ready to measure the tube voltages. This procedure will best be illustrated by relating the results obtained with a type 58 tube. This example will also explain the use of the Socket Connection Chart, which tells which tube elements are connected to the standard socket numbers on the selector switch for each tube given.

Turn the selector switch, Sw.1, to the No. 1 position, reference switch, Sw.1A, to K, and press button Sw.1B to read voltage. This test gives 100 V. for position No. 1, which is the screen-grid voltage. Proceeding to No. 2 (P) and pressing button Sw.1B for each time that we read voltage, we get 245 V. for the plate voltage. For 3 (cap), we get an almost imperceptible backward movement until we reverse with Sw.4, and change to the next lower voltage range on the meter. This gives us 6V. for the control-grid voltage. For position 4 (CH), we read -6V., giving us chassis-to-cathode voltage. For position No. 5, we get no reading, since this is K to K voltage. For position No. 6, we read -6V., which is the voltage from suppressor-grid to cathode (in this particular set). And finally, since this is only a 6-prong tube, we get no reading for position No. 7, and no reading for No. 8, which is reserved for an 8-prong tube.

Having finished the voltage readings, we remove the leads and connect them from the MA terminals of the unit to the 25 ma. range of the meter. When reading current, the selector switch and all the other voltage switches (Sw.1, Sw.1A, Sw.1B, and Sw.4) are automatically disconnected from the circuit, thus allowing no chance for cross connections. To read the plate current, now, all that is necessary is to press the current button (Sw.2). In our example we get a reading of 7 ma. Since this tube has a cap, we press the grid-shift button, Sw.3A, keeping the current button down, and we read 6 ma., giving us a plate-current change of 1 ma. This completes the voltage and current readings for this tube, and the same procedure is repeated for the other tubes in the set.

The meanings for the numbers on the selector switch are given below in the sample Socket Connection Chart. For the most frequently used tubes, these meanings will be mastered very quickly with use.

CONDENSED SOCKET CONNECTION CHART

Type of Tube No. Prongs Sample Tube	Position of Sns. 1								Position of Sns. 1A
	1	2	3	4	5	6	7	8	
4-prong 45, 2A3, etc.	G	P	CH						
5-prong 27, 56, etc.	G	P	CH	K					K
5-prong 35, 36, etc.	S	P	G	CH	K				K
5-prong 47, 33, etc.	S	P	G	CH	S				K
6-prong 41, 2A5, etc.	S	P	G	CH	K	G			K
6-prong 55, 75, etc.	D2	P	G	CH	K	D1			K
6-prong 58, 6D6, etc.	S	P	G	CH	K	S3			K
7-prong 59	S	P	G	CH	K	S3	G		K
7-prong 2B7, 6B7, etc.	S	P	G	CH	K	S3	D1	D2	K

Note: G, grid; P, plate; S, screen-grid; S3, suppressor grid; D1, first diode plate; D2, second diode plate; CH, chassis; position 8, spare.

A complete chart, such as this, will serve as a handy reference for the newer type tubes with their many different socket connections. It can be prepared from the information given in Tube Characteristic Charts furnished by the various tube companies; or, better yet, from the "Handy Reference Index" which was published in the March issue of RADIO-CRAFT, and which gives the socket connection for almost all tubes. A chart, compiled from the latest data for all the new tubes is also furnished with the kit of parts for those who wish this information in convenient form.

(B) A.C. Measurements:

If A.C. ranges are available on the external meter, the following measurements may be made:

Use the other two binding posts, H-H, to get the heater voltages.

For the 80 rectifier tube, the A.C. voltage per plate may be measured at settings Nos. 1 and 2 of the selector switch, with the reference switch, Sw.1A, set to P.

For output meter work, the voltmeter binding posts, V, will furnish the plate and cathode connections with Sw.1 set to No. 2 and Sw.1A set to K.

(C) Rectifier Tests:

The plate current of one plate of the rectifier is obtained in the regular way by pressing the current button Sw.2. However, the best test for the rectifier is to substitute a good tube in its place and to compare results (comparing, for instance, the plate current of the power tube before and after the substitution is made). Substitution is the best service method possible, if used with discretion, especially for the rectifier tube.

(D) Resistance Measurements:

To measure the resistance between any socket prong and cathode the voltmeter binding posts of the unit are connected to the ohmmeter range of the meter and manipulated in the same way as for voltage. This allows measurements, like chassis-to-cathode, to be made through the socket without resorting to test leads.

A word about the 7-prong socket situation would be in order here, as there are two sizes of 7-prong sockets on the market, namely the large 7 to fit the 59 tube only, and the small 7 for the newer tubes like the 2A7 and the 2B7. From reliable sources we learn that the policy for the future 7-prong tubes will be to use the small 7-prong socket exclusively. For this reason the analyzer plug used here fits the small 7 socket, and uses a 7-7 adapter for the 59 tube, to make it useful for the present and future 7-prong tubes. Also, the plugs and adapters are of the small kind to fit the new type of close fitting shields. The 7-prong socket used on the analyzer unit itself is a 7-7 combination socket and takes both large and small 7 prong tubes without any adapters.

In conclusion, it is to be noted that the use of the unit idea for the analyzer and meter sections offers a very flexible arrangement that may be used in many different ways. For those starting from scratch, both units may be built on panels of the same size to take advantage of using a carrying case to fit both. Others may be built to fit the cover of the meter unit they already have, by merely using a slightly deeper cover. For those who own volt-ohmmeters without any milliammeter ranges, we suggest that it will be well worth the cost to add 0-10 ma. and 0-100 ma. ranges by installing two shunts, two pin jacks, and a toggle switch. The effectiveness of any combination chosen will naturally depend on the merit of the companion meter job; and, although the cost of building the analyzer units is comparatively small (about \$12 or \$13, this unit can rightfully take its place beside the best of meter outfits.

List of Parts

- One 8-point tap switch, non-shorting type, Sw.1;
 - One 3-position switch, Sw.1A;
 - Two Leeds push-button switches, type SC, Sw.1B, Sw.2;
 - Two D.P.D.T. push-button switches, Sw.3, Sw.3A;
 - One D.P.D.T. toggle switch, Sw.4;
 - One NaAld 4-prong socket, type 424, V1;
 - One NaAld 5-prong socket, type 425, V2;
 - One NaAld 6-prong socket, type 436, V3;
 - One NaAld combination 7-prong socket, type 477, V4;
 - One NaAld 7-prong analyzer plug, type 907 WLCA;
 - Three NaAld analyzer plug adapters, type DSA, 7-4, 7-5, 7-6;
 - Four Tri-Leeds binding posts, two red and two black, V, MA.;
 - Two plug binding posts, H-H;
 - One pin jack and control-grid clip, G-C;
 - One push-type binding post, CH;
 - One spring clip;
 - One Leeds panel, 5 1/4 x 8 1/2 inches;
 - One complete tube chart.
- The accessories are:
- One 4.5-volt "C" battery;
 - One Leeds portable case cover (optional);
 - One Leeds case, 8 1/4 x 8 3/8 x 3 ins. (inside dimensions);
 - One NaAld analyzer plug adapter, type DSA, 7 to 7 for type 59 tube only (optional).

A POWER CRYSTAL SET

(Continued from page 36)

er. Furthermore, the 33 requires a control-grid potential of only 13 V., as against 22 V. for the 31, to obtain the rated power output.

For the last point, that of uneven wear on the batteries, we can use series resistors to drop the total battery voltage to that necessary for the screen-grids of V1 and V2; and an additional resistor to supply grid-bias for the power tube, V2, thus eliminating the "C" or grid-bias battery; quite a considerable advantage. Screen-grid and "C" bias voltages are now obtained "automatically," and drop in "B" voltage is automatically compensated in the screen- and control-grid circuits.

Construction

The position of the parts is very well shown in the photograph, Fig. A, and is almost exactly similar to the original layout. A "3-circuit tuner" takes the place of the antenna coil at the left, and a 5-prong socket is substituted for the 4-prong at the extreme right. For ease of control and shorter leads in the present model, the tuning condenser has been moved to the extreme left and the 3-circuit tuner mounted on a small panel just beside it; but these are the only changes from the original layout. About the only other point of importance to watch is the connection of the electrolytic bypass condenser C6 across the V2 grid-bias resistor R5. *This condenser must be connected with the positive end to the filament post of the socket.* The positive end will be found marked in red. If this condenser is connected in backwards, it will be ruined rapidly; which observation holds true for most types of electrolytic condensers. The resistors and condensers specified are all of the pigtail type, and these pigtails, if properly soldered, will supply all the mechanical support required. But be sure that these pigtails, and all other wires, are properly soldered to good, clean surfaces, using a hot iron and rosin flux. An improperly soldered joint, either loose or held only with rosin, can supply the builder of a radio set with a greater assortment of rattles, scratches, and noises than any other single cause. And in addition, they are mighty hard to locate; so play safe, take a little more time in construction and be sure that each joint, as you make it, is right—then if trouble develops later the joints will be one place that you will not have to suspect. And screw everything down tight to the baseboard; if necessary, use insulated staples to hold down long runs of wire, and you will not be troubled with shorted batteries or get 135 volts across the filaments of the tubes—which doesn't do them a bit of good!

Use a definite system in your work. First assemble all the tools, wire, and parts you require; then do all the mechanical work. Mount some sort of a pointer on the tuning condenser as shown in Fig. A, and mount the tuning coil on its little panel. Screw each piece of apparatus to the baseboard, following the layout in the photograph. Next wire the filament circuit and test it by putting a tube in each socket with the "A" battery connected. In daytime the filament will show only a slight glow. *Do not permit the filament potential at the tube to exceed 2 volts.*

Next wire all the plate and screen-grid circuits; and finally, the control-grid circuits. As you put in each wire mark it out on the diagram with a red pencil because one wire left out will prevent operation of the set, and it is usually quite difficult to locate the missing wire, especially for the beginner.

Fahnestock clips are used for antenna and ground connection. A couple of leads are used for connecting to the — and + terminals of the "B" batteries; two more are used for the — and + terminals of the "A" cell. These four leads are conveniently identified by means of tags. Be sure not to reverse one of the "B" batteries when connecting the three in series; connect the — terminal of one cell to the + of the next, etc.; there will remain only one — and one + terminal for connection to the two "B" leads from the power crystal "breadboard" set.

The most difficult job will be the tapping of the coil for the police signals; but if care is exercised in pushing out the thirtieth turn (from the tickler end) and scraping it clean

before the small wire is soldered fast, it can be done. Be sure to place a piece of fiber or bakelite under the wire before attempting to solder it, or else the celluloid form may take fire, even if the wires are only charred, the coil will be rendered useless.

The Jack J1 shown in the control grid circuit of the first tube, V1, is intended for a phonograph pickup and may be left out if no pickup is available. A microphone transformer may be connected to the plug, in place of the pickup, and used in conjunction with a microphone and battery for "home broadcasting."

A 2 mf. condenser will be required at C if the "B" batteries get too weak, or if a "B" eliminator is used for the "B" supply.

Operation

When the last wire is marked out on the diagram, the set is ready, presumably, for operation. Place the tubes in the sockets, connect antenna and ground, and plug in the headphones or speaker if you have no phones. Then connect the "A" battery and check the filaments to see that they light properly. Connect one wire to the "B" battery and flip the other on the other "B" contact; a loud click indicates that the circuit is free from shorts and grounds. Make a permanent connection with this wire. A loud huzz in the speaker indicates that the little wire in the crystal detector is not making contact with the roller, and should cease when this contact is made. Plug in the phonograph pickup, if you have one, and start the record. If everything is correctly wired you should be rewarded with clear, undistorted music of comfortable room volume. If you have no phonograph pickup, a good way of checking the audio system is to put a moistened finger on the control-grid (the cap) of the first tube; the result will be a loud hum or buzz if everything is normal. Another test is to bring a wire carrying alternating current close to this first control-grid lead; a loud 60-cycle hum from the speaker indicates correct operation.

Now pull out the plug which connects to the phonograph pickup and get your patience all primed up, because you're going to need it. On one end of the crystal detector is a little knob, moving this knob back and forth and in and out makes it possible to adjust the contact between the little wire inside the detector and any part of the crystal cylinder in order to find the most sensitive point and to allow the continued use of the crystal should a burst of static burn out one point, as it sometimes does. With headphones on, move the tuning dial slowly from one end of the scale to the other and at the same time "fish" for a sensitive spot on the crystal. A light contact, with the wire just barely touching the crystal will be found to be best. This operation will result in considerable rattling and scratching in the phones, but you will eventually hear music or speech. When you tune in a station, leave the crystal at that point and bring it in as loudly as possible with the tuning dial, then leave the dial set and experiment with different contact points and pressures on the crystal until the best results are secured. When this point is found you can search for more stations with the tuning dial and regeneration control.

A word about this regeneration control may not be amiss. It will not cause loud squeals in the phones, nor will it radiate from the antenna to cause interference in all the neighbors' sets (except, possibly at the very shortest wavelengths). It is not strongly regenerative—the energy feedback is only enough to sharpen up the tuning slightly without interfering with the "crystal tone quality." It can be used, also, as a volume control, since in one position the feed back is in phase and will aid the incoming signal, and in the opposite position it will buck the incoming signal.

The direction of the signal path through the crystal will affect the regeneration, and, therefore, the two wires leading to the mounting jacks for the crystal must be tried two ways and left in the one that gives the best results. An off-on switch may be connected at X, in Fig. 1, if desired.

(Continued on following page)

SAVE

3 gals. IN TEN

WITH CENTRALAB MOTOR RADIO SUPPRESSORS

An automobile distributor reports 11.8 miles per gallon with his car equipped with ordinary suppressors. The mileage jumped to 15.8 m.p. gal. an increase of 34% with CENTRALAB.

Sell Centralab Suppressors for complete customer satisfaction. Insist upon them for original equipment. Retail price 40c each in all styles.

Centralab

CENTRAL RADIO LABORATORIES,
930 E. Keefe Ave. Dept. C Milwaukee, Wis.



Books and lectures on the marvelous accomplishments of the Photo-electric cell must inspire you, but only by experience with the actual device can you get the FEEL of a Photo-cell; only by owning and working with the tools of Photo-electricity (a complete kit) can this science become a powerful reality rather than the intriguing mystery that it must be to you now.

Years of experience manufacturing Photo-cells and allied instruments have placed us in a position to supply the most dependable apparatus known. The Kit we offer consists of only the highest quality merchandise: a Photo-electric cell, amplifying tube, magnetic relay, condenser, resistors, socket; everything that is essential for the ideal unit, though your problem is to control illumination, detect burglars, count articles in production, guard machinery or accomplish any of the innumerable feats which are practical for Photo-cell control.

Our price is an achievement in itself. \$8.00 the complete kit.

The Clark Instrument Company
Camden, N. J.

AC-ROYAL-DC Universal



Complete with
Sylvania Tubes
90-day
Guarantee

\$9.95
net

l.o.b. N.Y.

4-tube set—uses 78-77-43-25Z5—\$9.95 complete.

5-tube set—uses 78-77-43-two 25Z5—\$10.95 complete.

8-lb. model—has full dynamic speaker—hand rubbed walnut cabinet—automobile outlet—self-contained aerial—can be used on 110 V. AC and DC—all cycles, 6 and 32 volt farm systems.

These fast moving values have earned quick profits for live dealers. Sell two to a customer at this low price. Direct-to-dealer policy insures full dealer profits. Order sample now.

ROYAL RADIO, INC.,
215 W. 125th St., New York City

MAILING LISTS

Pave the way to more sales with actual names and addresses of live prospects.

Get them from the original compilers of basic list information—up to date—accurate—guaranteed.

Tell us about your business. We'll help you find the prospects. No obligation for consultation service.



FREE
60 page Reference
Book and Mailing
List Catalog

Gives counts and prices on 8,000 lines of business.

Shows you how to get special lists by territories and line of business. Auto lists of all kinds.

Shows you how to use the mails to sell your products and services. Write today.

R. L. POLK & CO.

Polk Bldg.—Detroit, Mich.

Branches in Principal Cities

World's Largest City Directory Publishers

Mailing List Compilers. Business Statistics. Producers of Direct Mail Advertising.

TO ALL RADIO MEN!

The advertisement which appears on page 56 of this issue is extremely important. Everyone should turn to this page NOW and read it carefully.

SERVICEMEN!

THE MOST COMPLETE LINE OF CONDENSERS AND RESISTORS FOR EVERY RADIO USE

Write for our new 8-page Catalog folder free of charge

AEROVOX
CORPORATION

76 Washington Street

Brooklyn, N. Y.

Troubles

For the benefit of the novice we give below a short tabulation of the most common troubles and suggested remedies.

No Signal or Noise:

- Filaments not lit. Check.
- "B" battery polarity reversed.
- Speaker jack making poor contact.
- "B" battery line open somewhere.
- Bias resistor R5 defective.
- Tubes making poor contact in sockets.

Loud, Rough Buzz:

Control grid line open somewhere, perhaps at crystal detector.

Motorboating (the term is exactly descriptive of the sound):

Worn-out batteries, a 2 to 4 mf. condenser (C, in Fig. 1) across them will sometimes stop it.

Bypass condenser open somewhere.

Weak Signals:

Incorrect screen-grid voltage on the first tube. Try different values for R4 as commercial resistors have not always the value marked on them.

Open bypass condenser, either C2 or C6.
Poor set location: poor antenna or ground.
Poor detector, D, or incorrect adjustment.
Tubes below par.

Batteries low.
Defective headphones or reproducer.
Leaky condensers (particularly, C3), or off-value resistors.

Reversed "A" connections.
Tickler reversed.
Shorted turns at tap S on coil L1.

In the List of Parts several items are listed for specific reasons: substitutions may be made at the discretion of the constructor. For instance, the crystal detector was selected for its flexibility of adjustment—the cat-whisker may be adjusted to touch any part of the crystal's surface, and then the pressure adjusted "to a T"—an important factor in obtaining maximum sensitivity. The 3-circuit tuner is of small-space type; however, it was selected for the design of its tickler coil which may be rotated 90° either side of zero coupling, thus permitting in-phase or out-of-phase feedback. The specified batteries fit on the baseboard.

List of Parts

- One Gen-Win type 301, air-wound, 3-circuit tuner for 350 mmf. tuning condenser, L1;
- One variable condenser, 350 mmf. (tuning unit), C1;
- Two Concourse fixed condensers, 200 V., 0.5-mf. (screen-grid bypasses), C2, C4;
- One pig-tail type mica-dielectric fixed condenser, .01-mf. (coupling unit), C3;
- One pig-tail type mica-dielectric fixed condenser, 350 mmf. (plate load resistor bypass), C5;
- One Concourse dry electrolytic fixed condenser, 25 V., 20 mf. (grid-bias bypass), C6;
- One crystal detector, D;
- One closed, single-circuit jack (for phonograph pickup), J1;
- One open-circuit jack (for headphones or magnetic reproducer), J2;
- One porcelain base, S. P. D. T. knife switch, Sw. 1;
- One type 32 screen-grid tube (first A.F.), V1;
- One type 33 pentode tube (second A.F.), V2;
- Two clips, Ant., Gnd.;
- One dial for C1;
- One knob for L1 (tickler);
- One baseboard (a "breadboard"), 10x14x $\frac{3}{8}$ -in. thick;
- One Lynch resistor, 1meg. 0.5-W. grid voltage-dropping unit), R1;
- One Lynch resistor, 0.25-meg., 0.5-W. (plate load resistor), R2;
- One Lynch resistor, 1 meg. 0.5-W. (leak), R3;
- One Lynch resistor, 5,000 ohms, 0.5-W. (screen-grid voltage dropping unit), R4;
- One Lynch resistor, 750 ohms, 0.5-W. (grid bias unit), R5;
- One Amperite filament ballast resistor, with mounting, type 3-1, or a 10-ohm rheostat, R6;
- One roll solid push-back hookup wire;
- One No. 6, 2 V. storage cell, "A";
- Three No. 762, 45 V. batteries, "B";
- One phone plug.

THE ORSMA BULLETIN



THE BIGGEST NEWS-MAGAZINE IN
THE RADIO INDUSTRY
Issued Monthly for Radio
Service Men

This new magazine is filled with interesting service information; plans of the Association; Service Men's experiences; answers to inquiries about servicing; hints on making extra money in the servicing field, in short, it is a magazine written for and by members of the ORSMA. It is the voice of the Association in which the problems and suggestions of the individual members are presented for review and discussion among the fraternity. It is a magazine for, of and by the Service Man, edited by the staff of RADIO-CRAFT Magazine, sponsors of the OFFICIAL RADIO SERVICE MEN'S ASSOCIATION.

In appearance this BULLETIN is made up in the style and size of a tabloid newspaper. It contains up-to-the-minute service information. A partial contents of the average issue is found below:

EDITORIAL—Advice to the young Service Man—How to get started.

SERVICING EXPERIENCES—The methods used to overcome unusual and difficult service jobs.

SERVICE MEN'S EQUIPMENT—Favorite testing units of "veteran" Service Men.

EXPOSING THE SERVICE "GYPS"—A continuation of the war against dishonest service work.

THE SERVICE MEN'S OWN FORUM—There the views and problems of the members may be "aired."

ELECTRIFYING AND MODERNIZING OLD RECEIVERS—As a source of income for the Service Man.

MAKING MONEY AT SERVICING—Methods of advertising and extending business employed by successful Service Men.

THE RADIO SERVICE MEN'S BUYING GUIDE—A classified directory of radio manufacturers and supply companies which allow special discounts to Members.

THE QUESTION BOX—Questions asked by Service Men and the answers.

EMPLOYMENT SERVICE—Ads inserted by companies in need of Service Men and Members looking for employment.

Subscription Rates for the ORSMA BULLETIN

ORSMA Members		Non-Members
50c	one year	\$1.00
\$1.00	two years	\$1.75
\$1.50	three years	\$2.50
\$2.00	four years	\$3.00
\$2.50	five years	\$3.75

Price of Single Copy 10c

Subscription Blank

Executive Secretary O. R. S. M. A.,
98 Park Place, New York, N. Y.

Enclosed find my remittance of \$..... for which please enter my subscription to your BULLETIN for years.

- I am a member of The Association and my Membership Certificate number is.....
- I am not a member, but would like to receive your application blank to join the O. R. S. M. A. (no fees—no dues to be paid by me).

Name

Address

City..... State.....

OPERATING NOTES

(Continued from page 33)

A new .05-mf. condenser—the correct value—was installed, and the chassis replaced in its cabinet. This unit is riveted to the chassis and located to the left of the volume control. The schematic of this receiver is shown in Fig. 2.

Fading in over twenty of these models has been eliminated by replacement of this condenser, or similar units connected in the same manner in the R.F. and I.F. stage; the R.F. condenser is located on top of the chassis near the antenna coil, and the other near the second I.F. transformer.

RCA Victor 79

The automatic phonograph control mechanism, phonograph volume control, and the remote cable have been the subjects of numerous service complaints in this set. The automatic phonograph has been the chief offender because of the many required delicate adjustments, some of which will be described.

This instrument utilizes remote control, comprising two motors, located at the receiver proper that are actuated by conveniently arranged push-button switches; one motor is used for tuning and control of volume for both radio and phono, and the other for driving the multi-contact change-over switch for radio, phono, and for home- or radio-recording. The remote-control box performs the following functions: switches the receiver "on" or "off," controls volume, selects any one of four pre-determined stations, and causes phono-radio change-over.

When depressing the radio or phono buttons either at the remote-control box or at the receiver to change over from radio to phono operation, or vice-versa, fails to produce any response, it is likely that the 2.5-volt pilot light under the indicating lens on the left side of the phono board is defective. This pilot light ordinarily lights up when either of these two buttons or the radio or home-recording buttons are depressed until the change-over switch has reached the desired position.

The phonograph volume control is part of a dual unit; one section of this control is used for radio. This unit has given much trouble because of noisy operation. The connection to the movable arm of the control is made by a wiping contact which rests against a lug in the center of the cover, and which is insulated from this lug. It is very simple to pry off this cover and clean both the lug and wiping contact. A better repair, and one that will last indefinitely, is to install a pigtail between these two points.

Several cases have been reported where the buttons on the remote-control box have failed to respond when pressed unless the box is held in certain positions. This has been traced to a break in one or more wires in the flat remote-control cable. This break is usually found within two feet of the control box and more often than not, just at the point of entry. To discard the whole cable because of this defect is ridiculous and unnecessary, but it has been done. The cable may be cut away at the break after the insulation has been slit down from the lugs and each lead marked, so that the proper connections may again be made.

The automatic phonograph mechanism used in the RCA Victor model RAE 79 is the same as that used in models RAE 26 and RAE 59. Although the difficulties experienced with this mechanism are varied and numerous, they may be classified under five headings, but only those causing the most trouble will be discussed.

(A.) When the record magazine swings across into position, the record is not deposited upon the turntable, but is carried back with the magazine. This condition is usually caused by the incorrect position of the record transfer lever, which may be adjusted by loosening the two screws at its base and shifting the lever so that when a record is placed against the two pins on the lever, with the latter in a horizontal position, the record hole is above the spindle. Finally, it should be ascertained whether the lever will clear the record when the latter is deposited upon the turntable.

A weak spring in the top of the spindle may also cause the same complaint.

(B.) As the record magazine returns to position after having deposited a record upon the turntable, the bottom record or records are dislodged. Invariably, this complaint is due to an incorrect adjustment of the magazine



UNIVERSAL AC-D.C. BATTERY

SUPERHETERODYNE

For Farms—Ships **AUTOMOBILE** —City Apartments

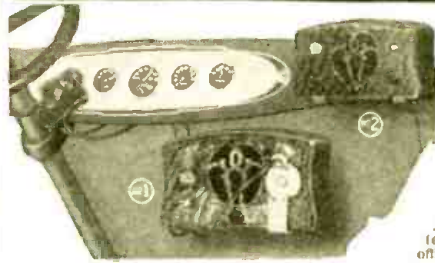

Build Your Own Auto Superhet
Get actually eight tube performance with this powerful A.C. D.C. or Battery Superheterodyne. Utilizes the latest 6A7 Pentagrid converter as a combined oscillator and modulator, 7B Intermediate, 77 second detector, 41 or 45 as a power amplifier, and the new 272A Full-Wave Voltage Doubling Rectifier. Designed by Thomas A. Crossley, well-known radio engineer. Unconditionally Guaranteed.

Note Special Features
Dynamic speaker—Tone control—Illuminated Vernier Dial—Auto—Battery, and 32-volt Outlet contained. Genuine inlaid Walnut Cabinet. Police signals—8 pounds 10 x 6 1/2 x 4 3/4" deep. No ground or outside aerial necessary. Set works on A.C., 110 volt—130 volt—220 volt, all frequencies. D.C. Battery or Delco Systems. Can be used in an auto—motor boat—office—farm—camp—hospital—bedroom—den—hotel—seashore.

And Ideal Auto Receiver

Can easily be installed anywhere in an automobile. Will play without aerial or ground. Connected in a jiffy. Will operate from 2 or 3 45-volt "B" batteries or our Postal Auto "B" Effluxator. Each kit supplied with complete, simple pictorial and schematic wiring diagrams.

COMPLETE KIT	\$11.95
Matched set of 5 R.C.A. Arcetron, or Sylvania tubes	4.95
Genuine Walnut Cabinet	2.60
Regular Price	\$18.30
SPECIAL OFFER: The above Kit Complete	\$15.95
COMPLETE SET as listed above, ready to operate	\$16.95
Postal Auto "B" Kit	\$8.40
Postal Auto "B" Ready to Operate	\$10.15

IMMEDIATE DELIVERY: All orders shipped within two hours after received. Sent C. O. D., or remit in full less 2%.

POSTAL RADIO CORP.

135K Liberty St., New York, N. Y.

Cable Address "POSTALRAD," N. Y.

4-TUBE UNIVERSAL AC-DC OR BATTERY RECEIVER



Complete kit, (With Tubes) **\$11.80**

COMPLETELY READY TO OPERATE **\$12.80**

roller. The locknut of the roller should be loosened and the roller adjusted so that it is not only at right angles to the record magazine shaft, but it should be raised so that it will just touch the magazine when it is empty and passing through its cycle.

(C.) Occasionally, the record is rejected and the mechanism repeats its cycle as soon as the pickup lowers onto the record. Stating only one major reason for this complaint is difficult because of the many contributing causes. At any rate, main causes are listed. The four-finger lever is mounted and operated on a riveted joint. This rivet works loose, making the lever shaky and often dislodging the long finger of the lever so it swings into position against the flat side of the clutch pawl, starting another cycle. The lever must be made steady by hammering down the rivet, but not so much as to cause the lever to stick. At other times, it has been found that the four-finger lever spring, which is about an inch long and one end of which is fastened to a stationary post, has insufficient tension to hold the long lever in place against the clutch pawl. Part of the spring may be cut off to increase the tension. Usually, however, the mechanism may be closely observed in operation without records or turntable, and the long finger of the four-finger lever may be bent slightly up or down so that it engages properly with the clutch pawl without slipping.

(D.) The mechanism continually trips and cannot be stopped even though the "off" button has been pressed and the line plug has to be removed to stop it. This state of affairs is caused mostly either by improper adjustment of the switch actuated by the bracket attached to the rear of the slide or incorrect timing. As soon as the mechanism has finished its cycle, the contacts of this switch should open, and close only when the mechanism has tripped. If this switch is found at fault, it may be shifted into position by loosening the two mounting screws, one of which rides in a slotted hole. In the event the setting of this switch is correct, it is most likely that the gears are improperly timed, a correction for which is simply described in the RCA Victor manual.

(E.) Pickup lowers onto outer smooth rim of record, but either does not slip into the first groove or slides across several grooves. This condition is almost always caused by insufficient or too much tension of the flat spring which presses against the tone-arm locating lever. The spring may be bent slightly one way or the other to secure the necessary tension adjustment.

WANTED!



Jobbers—Mail Order Houses and Representatives in all territories.

TWO FAST MOVERS



Free Edge Cone and Voice Coil Assemblies.
And—
Field Coils for all Dynamic Speakers.

We can supply and remedy your Speaker needs. *Speaker Mfrs. Since 1921*

Leotone Radio Co.
63 Dey St. New York, N. Y.

A GREAT BOOK

\$1

per year



122 pages of live service data, kept up-to-date by Mail your dollar now to Dept. RC-7. Ten days' trial. Money back if not satisfied.

175 Varick St., New York, N. Y.

ELECTRAD

INC.

KLEK SOCKETS



FOR AMPLIFIER, RECTIFIER, AND TRANSMITTER PANELS

Will put your tubes in front where they can be seen and easily changed.

4, 5, 6, 7 Prong Postpaid \$2.00

KLEK-SOUND-EQUIPMENT
3923 Montrose Ave., Chicago, Ill.

SERVICEMEN.....

YOU NEED THE 950TR ADAPTER

What are you going to do when you get one of the 25Z5, 43, 48, etc., high filament voltage tubes to check? The Na-Ald 950TR adapter is the brand new Na-Ald 950TR adapter in the 24 socket of your present tube checker. The self-contained transformer and switch in the 950TR is designed for testing ALL 10, 12.6, 14, 15, 25 and 30 volt tubes. At last, just what you were waiting for. 950TR Transformer Tube Checking Adapter. List Price \$6.00



EQUIP YOUR ANALYZER WITH THIS PLUG AND BRING IT UP TO DATE. DIAGRAMS AND DIRECTIONS SENT FREE WITH ALL ORDERS.

907WLCB New Small Size Seven Prong Na-Ald Latch Lock Analyzer Plug with Twin C. G. Handle and five feet of EIGHT wire cable attached. **907WLCB** (as described) List price...\$5.50

907WL Same without cable List price...\$3.50

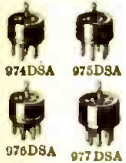

This plug fits the latest small seven sockets. For UX 4-hole sockets the **974DSA** adapter is snapped onto the Plug; for UX 5-hole sockets the **975DSA** is used; for 6-contact sockets the **976DSA** and for the 59 seven contact socket the **977DSA** is required. Each of these four new SMALL SIZED associate adapters. **974DSA, 975DSA, 976DSA** and **977DSA** have a list price of \$1.25 each.

REPLACE YOUR OBSOLETE SOCKETS WITH THESE LATEST COMPOSITE SOCKETS

456 replaces sockets requiring a 1 3/16" panel hole and 1 1/32" mounting hole spacing. Receives all 4, 5, and 6 prong tubes. Filament circuits common—all others isolated—has nine contacts.
List price.....\$.50

456E replaces sockets requiring a 1 3/8" panel hole and 1 1/16" mounting hole spacing, for contacting all 4, 5 and 6 prong tubes. List price.....\$.60

477 matches the **456** but receives all seven prong tubes of both tube bases. Has seven contacts.....\$.50

456E matches the **477** but has the same contacts.....\$.60

457 receives the 47 5-prong pentode and the 59 7-prong pentode. Cathode of 59 isolated from the screen-grid of the 47. Has eight contacts.....\$.50

Composite 5-7 socket. List price.....\$.50

457E same as **457** but has "E" mounting. List.....\$.60

457E receives all 5, 6 and small 7 prong tubes. Has seven contacts. Composite **567** socket. List.....\$.50

567E same as **567** but has "E" mounting. List.....\$.60

437E for the 59 medium based 7-pin tube. List.....\$.40

437 receives the small based 7-pin tubes. List.....\$.35

437EA for all small based 7-pin tubes. List.....\$.40

437A same as **437EA** but with 1 1/32" int.\$.35

436 six-contact socket with 1 1/32" int.\$.25

425 five-contact socket with 1 1/32" int.\$.25

424 four-contact socket with 1 1/32" int.\$.25

HERE'S THE QUICKEST, LOWEST COST METHOD OF MODERNIZING YOUR ANALYZER



965DW Enables any analyzer which can test 24 circuits to test all the new 6-prong tube circuits. **965DW** List Price. \$2.50

965DW Same with locking stand. List Price \$2.50

975DW Enables any analyzer which can test 24 circuits to test the 7-prong tube circuits. **975DW** List Price. \$3.00

975DW Same with locking stand. List Price \$3.00

975DWA For analyzing the new small 7 prong tube circuits. List Price. \$3.00

975DWS Same with locking stand. List Price \$3.00

TREAT YOUR OUTPUT METER TO THIS ADAPTER



This 9PL Output Meter Adapter contacts the slide projector 4, 5, 6 and 7 prong tubes without having a small or regular base—designed for use in the new close fitting shielded sockets and equipped with a serviceable 5 foot lead. May also be used for connecting pickups, microphones, plug-in extra speakers, tone controls, voltmeters, etc. **9PL** List Price.....\$.50

GET THIS ADAPTER TO MODERNIZE YOUR TUBE CHECKER



950XYL Universal Tube Checking Adapter tests over 80 NEW TUBES. No wires, no leads—no links—very simple to operate—circuit diagram and direction chart included—over 80 Na-Ald TUBES with sockets for recording readings at these and future tubes are supplied with all orders. List Price.....\$6.00

Your tube checker has no filament-voltage switch; the 950XYL Adapter must be used on the basis of the 950XYL 950XYL UY top—E 2 bottom—with C. G. lead. List Price. \$1.25

Be able to test the new small seven tubes, C47 and 3B7 in the 24 checker socket and the 6AY and 6BT in the 30 socket by using the 975-A17 Small 7 tube checker adapter. List.....\$1.00

"MAKE-YOUR-OWN" ADAPTERS

For those who wish to use tube bases sections for making their own adapters we have available the following tube-bases and top socket sections:

304 4 prong tube base.....10c	422 4 hole socket top.....25c
305 5 prong tube base.....10c	423 5 hole socket top.....30c
306 6 prong tube base.....10c	424 6 hole socket top.....35c
307 7 prong tube base.....10c	427 7 hole socket top.....35c
307A Small 7 tube base.....10c	427A Small 7 socket top.....35c

If you would rather have a specially designed plug section which fits into the closely shielded sockets and allows for taking off leads without shorting to the chassis, use these which come complete with assembly screw and nut:

934B 4 prong plug section 25c	937B 7 prong plug section 25c
935B 5 prong plug section 25c	937BA Small 7 plug section 25c
936B 6 prong plug section 25c	

Send for free catalog sheets showing all kinds of sockets, plugs, connectors, coil forms, etc.

Send a dime for the Na-Ald Adapter Data Sheets showing diagrams of over 300 different adapters for every purpose—descriptions, uses and directions are given on adapters for pickups, microphones, output meters, tone controls, short wave converters, tube checkers, set analyzers, etc., directions for connecting obsolete set analyzers, new tube-prong connectors, etc.

Ask for information on how to test the 25 and 30 volt tubes with any tube checker.

Servicemen's Discount 35%
On orders amounting to \$10.00 List.....40%

ALDEN PRODUCTS CO.
Dept. R-7 715 Center St.
BROCKTON, MASS.



CAPACITY TESTING

(Continued from page 28)

Range 2 of the chart, a 1 mf. condenser will give a meter reading of 280, while a 70,000-ohm resistor will read infinity. It is clearly seen that this condenser may be measured on Range 2 as follows.

Rotate the switch on the point-to-point unit to the G2 position, Fig. 1B. Remove the meter lead from the L position to the H-M position. Throw the T.P.D.T. switch, Sw. 3, to the M position, close the adjusting and line switches, adjust the meter to full-scale deflection using the H-M knob, open the adjusting switch, Sw. 2, and a meter reading of 280 will be obtained, which corresponds to a 1 mf. condenser. Again, looking at the schematic with regard to this circuit, it will be noted that resistor 50, of 25,000 ohms, is in series with any further path leading to the chassis, and as this test is made on Range 2, showing a meter reading of infinity from 20,000 ohms up, it is plain that no current will pass through this 25,000-ohm resistor; therefore, condenser 30 is measured for its actual capacity.

There are other condensers in this chassis that may be tested using the same methods described.

To test the first A.F., the analyzer plug is inserted in this socket. The test is to be made on condenser 30 (note: there are two condensers in one can both numbered C30), which has a capacity of .25-mf. and is located between the P socket terminal and chassis. See Fig. 3. Examining this circuit, we find that there are two different circuits to chassis. (The speaker plug is pulled out.) One circuit is from the P connection through a resistor of 25,000 ohms, R26, through a .25-mf. condenser, C30, to chassis; the second circuit is through resistors R26 and R27—a total of 50,000 ohms and continues on through condenser 57 of 6 mf. to chassis. Noting the values involved, it is plain to see that Range 1 must be used.

Therefore we refer to Range 1 of the chart and note that a resistor of 25,000 ohms will give a meter reading of 790, a resistor of 50,000 ohms will give a meter reading of 650, and a .25-mf. condenser, a full-scale reading. As stated before, a condenser that will read full scale on Range 1 will pass whatever current flows to it through the resistor with which it is in series. This being the case then, the path of least resistance will be from P through R26 and C30 to chassis. The meter reading is 790, which is the reading of a 25,000 ohm resistor, R26. If this condenser were open, the current would then flow from P through R26, R27, C57 to chassis, and a reading of 650 would be had on meter, which is the reading of a 50,000 ohm resistor, R26-R27.

The next test is made on condenser C23, of .01-mf. Condensers so connected in a radio set are the cause of considerable cutting off, and it is very useful to have some means of testing them quickly. However, test leads will have to be brought into use here. These are connected to the capacity pin jacks of the tester. See Fig. 1C. The test is made between the P socket terminal of "Det. Amp." and the G1 terminal of the first A.F. stage. It is important here that there be sufficient resistance between G1 and chassis, and chassis to P, to make sure that the current doesn't travel by either of these paths. Consulting Fig. 3, we see that between G1 and chassis there is R25 and C24, a total resistance of 240,000 ohms, the resistance of R25. From chassis back to the P terminal of the "Det. Amp." socket the circuit is through C24 (note there are 4 condensers in one can all marked C24 in schematic) and R21. The total resistance is 51,000 ohms, the resistance of R21. Therefore, the total resistance of the circuit G1 to chassis, and chassis to P, would be 291,000 ohms.

The capacity of C23 is .01-mf. this being the capacity under test. The resistance in the test is 291,000 ohms—call it 300,000 ohms.

To determine the path of least resistance, we again refer to Range 1 and find the following readings: a .01-mf. condenser, 390; and a 300,000-ohm resistor, 275. Therefore, condenser C23 may be tested for open. If a reading of 275 is obtained, it will show C23 open, as 275 is the resistor circuit reading.

The next tests are made in the second A.F. tube socket, the first of which will be the tone-control condensers, C31. The speaker plug is disconnected. The test is very simple, as these three condensers are alone between P terminal

CLASSIFIED ADVERTISEMENTS

Advertisements in this section are inserted at the cost of ten cents per word for each insertion—name, initials and address each count as one word. Cash should accompany all classified advertisements unless placed by a recognized advertising agency. No less than ten words are accepted. Advertising for the August 1933 issue should be received not later than June 9th.

DOGS

BEAUTIFUL Registered bull pups, \$15. Bull-dogs. 501-RC, Rockwood, Dallas, Texas.

INSTRUCTION

CANADA'S Oldest and best equipped radio school offers complete course covering Radio, Television, Sound Amplification, etc. Approved by leading radio manufacturers. No duty or exchange to pay. Radio College of Canada, Limited, 310 Yonge St., Toronto.

RADIO

MAGNETIC Speakers rewound and adjusted, \$1.25. Radio Service, Flora, Indiana.

GUARANTEED "Pocket Radio," \$2.00. Catalog, 10c. Neil Tasker, Shamokin, Pa.

TRANSFORMERS REWOUND, varnished, baked, guaranteed, reasonable cost. **SPEAKER REPAIRING**, magnetic \$2.00-\$2.50; dynamic, voice coils, fields, etc., reasonable charges. Clark Bros. Radio Co., Albia, Iowa.

ATWATER KENT Power packs with shorted condenser banks repaired cheap. Build a condenser tester, complete with plans 25c. Tests to 50 mmf. S. J. Lyon, 2039 So. Lawrence, Wichita, Kansas.

CRYSTAL Set—something new. Separates all stations. Operates speaker. Blueprint, 6 others. 25c coin. Modern Radiolabs., 1508 23rd Avenue, Oakland, Calif.

CRYSTAL Radio fans, "Melomite" crystal improves reception. 25c. Set making instructions included. "Selective" crystal set \$1.00, with phone \$1.85 postpaid. Melomite, 7723 Fairmount Station, Kansas City, Mo.

SCHUMACHER Fixed crystal ultra sensitive. Extra loud. Adjusted for distance. Permanent. \$2.00. Schumacher, 5854 Forbes St., Pittsburgh, Penna.

BLUEPRINTS Of new superheterodyne circuit. 5 tube A. C. operated receivers. Latest developed model. Newest tubes, long range, fine tone value and selectivity. 25c. Barretto Radio Laboratories, 13 Peck Slip, New York City.

MR. PROGRESSIVE MANUFACTURER

You realize that humidifying apparatus is a necessity in the American home, and you know, too, that the public will soon realize it. Just as stores, theatres, offices and homes are being built with air conditioners, so the older homes will demand light, inexpensive humidifying devices. Such an article will be a money-maker.

A new invention (patent application in progress) supplies this need, and its manufacturing cost is so low that it can be sold profitably at \$5.00. It is electrically operated, practical, decorative, so common that it may be attractively combined with a lamp; it not only humidifies the air, but may be used to perfume it.

This invention is for sale on a cash-and-royalty basis which will attract the progressive manufacturer to whom this is addressed.



For information, write to

HERMAN YOUNG
96-98 Park Place New York, N. Y.

Build

the New Electrified

A. C. "DOERLE"

2-Tube Receiver described completely in the July issue of

Short Wave Craft

25c A COPY

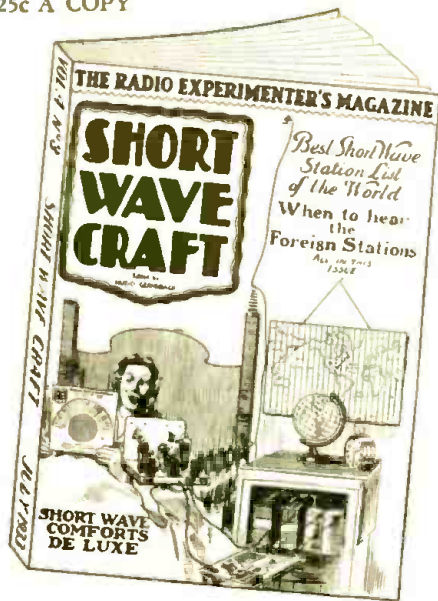

At All Large Newsstands

4-Color Cover 9"x12" In Size Over 200 Illustrations

RAPIDLY increasing each day are the number of experiments in the Short-Wave field—developments which are bringing to this branch of radio thousands of new "thrill seekers." Experimenters, as in the early days of Radio, again have the opportunity to bring about stirring new inventions. Read in **SHORT WAVE CRAFT**, the Experimenter's Magazine, how you can build your own Short-Wave Sets, both transmitters and receivers. **SHORT WAVE CRAFT** is exclusively a short-wave magazine—the kind you have wished for so long.

Feature Articles in the July Issue

- The "Ace High" Band-Spread 3, by Howard McEntee.
- The Electrified A. C. "Doerle" 2-Tube Receiver.
- Ultra Short Waves Guide Airplanes in "Blind Landings."
- Latest European S-W Circuits.
- Plenty of 2 and 3-Tube S-W Sets for the "Beginner."
- The "Air Rover" 2-Tube Receiver—Uses 2-volt tubes of the screen-grid and pentode types.
- 2-Tube Combination Regenerative-Oscillodyne Receiver, by J. A. Worcester, Jr.

SPECIAL OFFER COUPON

SHORT WAVE CRAFT RC-7
98 Park Place, New York, N. Y.
GET ACQUAINTED OFFER

- As per your Special Offer, I enclose \$1.00 (Canada and foreign \$1.20) for which enter my subscription to **SHORT-WAVE CRAFT** for 3 months. (I understand that your regular rate for a year's subscription is \$2.50.)
- Mail me a sample copy of **SHORT WAVE CRAFT** for which I enclose 15c (U. S. Stamps or coin accepted).

Name _____

Address _____

City _____ State _____

and chassis. The point-to-point unit is set on the P contact, Range 1 is used, and the tone-control knob located in the lower left-hand corner of the radio set is rotated to its respective positions. The following meter readings are registered: 390, 640, and 780, which correspond to capacities of .01-.02- and .03 mf. One of the filter condensers, C57, is tested next. The capacity being 6 mf., Range 3 is used. The tester is set for Range 3 by throwing the T. P. D. T. switch Sw. 3 to the H position, and the meter is connected to \pm and H.M. pin jacks. The point-to-point unit is set on the K contact, which is the screen grid of a 47 tube. The test is made between K and chassis: the speaker plug is disconnected. Close the line switch, Sw. 1, and the adjusting switch, Sw. 2, then adjust the meter to full scale. Open the adjusting switch and the test is complete. A meter reading of 315 should be obtained, which is the reading of a 6 mf. condenser.

This completes the test. By using the methods described, it is surprising to note the number of condensers that may be tested for opens and for their actual capacity between the tube socket terminals and chassis. It is beyond the scope of this article to take in every combination of resistor and condenser encountered; however, sufficient combinations were covered for the average Service Man to fully grasp the idea.

The Tester

Figure 4 is the schematic circuit of the capacity tester used in these tests. Switch Sw. 1 is the line switch; Sw. 2 is the adjusting switch; and Sw. 3 controls the three test positions; that is, when in the O position, the L range is being used with meter connected to pin jacks " \pm and L," and R8 is the adjusting rheostat for full-scale deflection. When in the M position, the M range is being used; the meter is connected to " \pm and H-M" pinjacks, and R9 is the adjusting rheostat; also, R4 is shunted across the meter, as may be seen. When Sw. 3 is in the H position, the H range is being used; the meter is connected the same as for position M, and R9 is also the adjusting rheostat. Resistor R5 is now connected across the meter and R1 is shunted across R9. These three ranges, L-M-H, represent Low, Medium, and High capacity, and correspond to Ranges 1, 2, and 3.

Resistor R1 is shunted across R9 on range H to protect R9, which is not capable of handling the heavy current of this range. Resistor R7 is a limiting resistor used to protect the meter from full line voltage being accidentally applied. Resistors R4 and R5 shunt the meter on Ranges M and H.

The circuit is very simple and no difficulties should be encountered in constructing it. It has no meter built in with it. This was omitted purposely, for it may be used with any 1 M.A. meter of the rectified type; and, as most Service Men have such a meter already connected up as a combination output, volt, ohm and milliammeter, they may make use of this capacity tester by simply connecting it to the 1 ma. A.C. movement of the meter.

If no provision is included in your combination meter for this connection, it may be done by bringing two leads from the A.C. side of rectifier to pinjacks. The capacity tester is then connected to these pinjacks as shown in Fig. 1D.

Attention might be called to R1, R2, and R3. These resistors handle heavy currents and, therefore, must have a rating of 20 watts. When using the H range, or Range 3, make your full-scale adjustments quickly, and don't leave Sw. 2 closed for long periods of time with the switch Sw. 1 closed. This range uses considerable current, and resistors R1, R2, and R9 may be damaged. A momentary switch may be used for Sw. 2, but this type of switch requires the use of both hands to make the full-scale adjustment—a toggle switch requires only one.

One 100-ohm resistor, 20 watts, R1; one 150-ohm resistor, 20 watts, R2; one 750-ohm resistor, 20 watts, R3; one Weston or Van 100 ma. shunt, A.C., R4; one Weston or Van 500 ma. shunt, A.C., R5; one 4,500-ohm resistor, 1 watt, R6; one 75,000-ohm carbon resistor, 1 watt, R7; one Electrad 50,000-ohm rheostat, R8; one Electrad, or equal, 400-ohm rheostat, R9; two S. P. S. T. toggle switches, Sw. 1, Sw. 2; One T.P.T.T. 3-position key switch, Sw. 3; five pinjacks; one bakelite panel, 6x3½x¾ inches; one bakelite wall receptacle, single screw mounting.

SUPREME

★ Announces

The Greatest
ADVANCE IN TESTING INSTRUMENT DESIGN SINCE

1929

A radical departure from the conventional—a new era of radio servicing as phenomenal as radio itself—

PRICES 60% LOWER

★
WRITE TODAY—FOLDER 333

★
SUPREME INSTRUMENTS CORP.
465 Supreme Bldg., Greenwood, Miss.



A MANUFACTURER can have no greater faith in his products than to guarantee their faithful operation, and with such a guarantee Tobe condensers are sold.



Tobe condensers are plainly branded with our trade-mark. We do not manufacture any condenser which does not bear the TOBE label. Accept no condenser as a TOBE or made by TOBE if it does not bear our trade-mark.

The replacement by-pass condenser, shown above, is only one of our complete line of Sparton replacement by-pass condensers available in ¼, ½, and 1 mfd. sizes. All Tobe Sparton replacement condensers are interchangeable with the units originally supplied by the receiver manufacturer. They embody the famous Surgproof construction and are impervious to moisture.

If your jobber cannot supply you, write

Tobe Deutschmann Corp.
Canton, Mass.

New! New!! New!!!

Two New 25c Short Wave Books

HERE IS GREAT NEWS



These new books will be welcomed by all short wave experimenters, short wave fans and short wave enthusiasts, the same as our former two books HOW TO BUILD AND OPERATE SHORT WAVE RECEIVERS, and HOW TO BECOME AN AMATEUR RADIO OPERATOR were welcomed by thousands of our short wave friends.

In conformity with the times these books have been priced at 25c instead of 50c, which is the price of our other books. Yet the two new 25c volumes contain a tremendous amount of information. The type and illustrations have been chosen in such a manner as to give you almost as much for your 25c as you received for your 50c before. You make no mistake in getting either or both of these new books and we know from our many years of experience with short wave enthusiasts that you will thank us for having made these books possible.

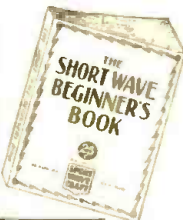

Ten Most Popular Short Wave Receivers. How to Make and Work Them

This new volume is a revelation to all those who wish to build their own short wave receivers. The editors of SHORT WAVE CRAFT have selected ten outstanding short wave receivers and these are described in the volume. Everything worthwhile about every one of the ten receivers is described in the text. Each receiver is fully illustrated and each receiver has a complete layout, pictorial representation, photographs of the set complete, hook up and all worthwhile modifications. Everything from the minutest one tube set to a 5-tube TRF receiver is presented. Complete lists of parts are given to make each set as complete as it is humanly possible to do.

Contents

2 R.F. Pentode SW receiver having two stages of TRF—2-Tube receiver that makes 2,500 mc. mark—My Deluxe SW receiver—Hi-newsie 2-tube 12,000 mc. DX receiver—"Brief Case" SW receiver—Denton 2-tube All-Wave receiver—Denton "Stand-By"—The "Stand-By"—Electric—Short Wave Midget—Coat Pocket SW receiver—SW Pentode—My Idea of a Good SW receiver—A Good "One-Tube."

IMPORTANT

THERE IS NO DUPLICATION WHATSOEVER BETWEEN THIS BOOK AND OUR OTHER VOLUME—"HOW TO BUILD AND OPERATE SHORT WAVE RECEIVERS." ALL THE MATERIAL PUBLISHED IN THE NEW BOOK HAS NEVER APPEARED IN ANY BOOK BEFORE.

A Short Wave Beginners Book

Here is a book that will solve your problems if you are new to the short wave game. It contains positively everything that you would wish to know in connection with short waves, leading you in easy stages from the simplest fundamentals to the present state of the art in short waves as it is known today. It is the only low-priced reference book on short waves for the beginner, whether he be a short wave enthusiast, short wave listener or short wave amateur.

The book is profusely illustrated with all sorts of illustrations, explanations and everything worthwhile knowing about short waves in this interesting and growing field. Yet without the book is not "technical."

It abounds with many illustrations, photographs, simple charts, hook ups, etc. all in simple language.

The book is just chock full of information and you will never regret having gotten this important volume.

Contents in Brief

Getting Started in Short Waves—Short Hand Symbols of Radio—Short Wave Calls and Aerials—Reducing Man-Made Static—Beginner's Short Wave Set—Increasing Volume by Adding Amplifier to One-Tube Set—Tuning Short Wave Set—Regeneration Control—Audio Amplifier for SW Set—Coating Speaker to Set—Learning Code—Wave Length and Kilocycle Chart—Wiring Chart—Links in Short Wave Construction.

Each book contains 40 pages—over 75 illustrations—25c each

Not sold on newsstands—Mail Coupon Today!

SHORT WAVE CRAFT
95-98 Park Place, New York City.

RC-733

- I enclose herewith 25c. for which please send me prepaid, a copy of your new book "Ten Most Popular Short Wave Receivers. How to Make and Work Them."
- I enclose herewith 25c for which please send me prepaid, a copy of your new book "The Short Wave Beginners Book."
- I enclose 50 for which please send me, prepaid, your two books, "Ten Most Popular Short Wave Receivers. How to Make and Work Them," and "The Short Wave Beginner's Book."
- (Send money order, check, or cash or new U. S. stamps. Register letter if it contains currency or stamps.)

Name..... Address.....

City..... State.....

RE SERVICE ELECTRIC Refrigerators!

In your community there are dozens of electric refrigerators to be serviced. Many need immediate repairs which can be made quickly, with little expense—and which you can repair with the aid of this authoritative Refrigeration Service Manual. Make many extra dollars, together with other repair work. Electric refrigeration servicing is a well-paying business—start in your spare time—before long you will devote full time to it. One or two jobs pays the small cost of the OFFICIAL REFRIGERATION SERVICE MANUAL.

96 Pages of New Data
Have Been Added to the
OFFICIAL REFRIGERATION
SERVICE MANUAL

To bring this useful service manual right up-to-date, Mr. L. K. Wright, the editor of the OFFICIAL REFRIGERATION SERVICE MANUAL, has added a wealth of material on new electric refrigerators, and older models as well. An usual every refrigerator has been accurately described from the viewpoint of servicing—diagrams to illustrate the essential parts so simplified that repairs can easily be made. The addition of these new pages will not increase the cost of the book to those who order their copy now.

Here Are Some of The Important Chapters:

- Introduction to the Refrigeration Servicing Business.
- History of Refrigeration.
- Fundamentals of Refrigeration.
- Description of All Known Types of Refrigeration.
- Motors.
- Trouble Shooting.
- Unit Parts, Valves and Automatic Equipment.
- Makes and Specifications of Units.
- Manufacturers of Cabinets, Refrigerants and Automatic Equipment and Many Other Important Chapters.

OVER 1,200 DIAGRAMS
450 Pages
Flexible Looseleaf Binder
Complete Service Data

Mail Coupon Today!



GERNSBACK PUBLICATIONS, Inc. RC-733
95-98 Park Place, New York, N. Y.

I enclose herewith my remittance for \$5.00 (check, stamps or Money Order accepted) for which you are to send me, postage prepaid, one copy of the OFFICIAL REFRIGERATION SERVICE MANUAL, together with the extra 96 pages of new material at no extra cost.

Name.....
Address.....
City..... State.....

Here's a book
every Radio Man will
refer to dozens of times
every day—



A Valuable RADIO BOOK!

HERE is one radio book that answers every conceivable question on interference. It contains 76 pages, 8 1/2 x 11 inches, chock full with wiring diagrams, drawings and photographs showing where interference originates—how it is distributed, and how to eliminate it. This is a wealth of information needed by every radio listener, dealer and Service Man.

Send fifty cents in stamps
or check for this book.

RADIO-CRAFT MAGAZINE
96-98 Park Place New York, N. Y.

THE DX FORUM

(Continued from page 38)

night, between CKGW and WWL, you will hear G2LD on 842 kc., if your set is very good; or try for the 60kw., Stuttgart, Germany, station on 833 kc., after KOA signs off about 2 A. M. E.S.T. You should not have a hard time to find them with your set. I had them twice in a week on a 6-tube superheterodyne with a 75 foot aerial! Let's hear from you.

P. J. AUBIN, (WIEAF and WIFGJ),
3 Water St.,
Putnam, Conn.

A SUPERHET BAGS NEW ZEALAND

Editor, RADIO-CRAFT:

Do not DX on U. S. stations (these can be picked up here in central U. S. from coast to coast on any common receiver); however, foreigners of any kind will give you difficulty on either short or long wave.

I do not log or ask for verifications from Mexicans as there are from 4 to 8 heard nightly; XEW, though, is one nice station.

A few of my catches are YV1BC, 960 kc.; RUS, San Salvador, 665 kc.; HJN, Bogota, Colombia 690 kc.; and one reception of Poste Parisien, Paris, on the morning of December 2, at or near 1:30 C.S.T. This is a 60,000 watt transmitter.

A few Cubans, CMCN, CMCD, CMK and CMAF, were heard almost nightly until their power was reduced from 1,000 watts to 500 watts.

KGU, Honolulu, 750 kc., also has been heard. Also have picked up Canadians CKY, CKOC, CFCO, 10AB, CKWX, and CKPR. Additional stations heard: WKAQ, San Juan, Porto Rico, 1,240 kc.; 2YA, New Zealand, 720 kc.; 3LO, Melbourne, 800 kc.; 2BL, Sidney, 855 kc.; 4RK, Rockhampton, 910 kc.; 4BC, Brisbane, 1,145 kc.; 3DB, Melbourne, 1,180 kc.

These stations were received on loud speaker, using a Lincoln type S.W. 33 De Luxe receiver, and were received only after the U. S. stations were off the air on these channels. If I can be of any help to the readers of RADIO-CRAFT, drop me a self-addressed, stamped envelope, and I will be glad to reply.

C. R. ANDERSON,
1026 1st N. E.,
Mason City, Iowa.

AN A.C.-OPERATED V.T. VOLTMETER

(Continued from page 30)

also mounted on a metal brace arrangement which carries the pilot light. The filter condensers are mounted at the rear with a metal clip. The filter choke is mounted in the center, on the subpanel, and is arranged to just clear the voltmeter. The tube sockets are also mounted on the subpanel. It will be necessary to bend the lugs on the 80 socket and mount the socket flat with a piece of cardboard underneath to prevent shorting to the galvanized subpanel. The 56 socket is mounted on standoffs made from copper tubing.

The box is made up from light pine and covered with auto top material. This makes a light durable case which looks like a manufactured product. The best system of fastening it to the box will be found to tack it to the inside edges with small tacks which will not quite go through the wood.

When the instrument is wired and ready to go, it may be tested as follows:

Set the voltmeter switch on the highest scale available. Turn the balancing resistance, R2, clockwise, as far as it will go and turn on the 110-volt line switch, Sw. 4. Then depress the push-button switch, PB, and set the plate current to a value close to zero by means of the resistance R2. It will be a good idea to mark the position of the pointer of the tuning meter with a heavy line for future reference. Now release PB. Connect the pin jacks to the potential to be measured, and reduce R1 until the tuning meter just reaches the original setting mark. At this point, the voltmeter's reading is just balancing the external potential being measured. In any case, the voltmeter selector switch, Sw. 3, can be placed so as to use the most accurate scale. Depress PB from time to

FOR SALE, BARTER AND EXCHANGE

As an aid to our readers, all advertisements to be inserted in this department are accepted at 2c a word; name, address, street number, etc., each counting for one word. No advertisement for less than fifteen (15) words accepted.

The Publishers are not responsible for difficulties arising out of the trades. In this department, only advertisements for private individuals can be accepted.

RADIO-CRAFT reserves the right to reject any advertisement that conflicts with the policy of this magazine. Send all "Swap" advertisements to RADIO-CRAFT, 96-98 Park Place, New York, N. Y.

Used stormproof trumpets and units. Must be reasonable and in good condition. Reason preferred. State full description and lowest price in first reply. Charles Armbruster, 433 South Center, Pottsville, Penna.

Will exchange now Peerless Signograph with six rolls of tape for Analyzer. Allwave Superhet or cash. John Lonzo, 822 Mountain St., Philadelphia, Penna.

Jewell Analyzer, Model 441 with adapters for new sets and tubes; Jewell 560 Oscillator and Jewell 209 Tube Tester. Write for details—will give you a real bargain on one or all. L. D. Kelly, 505 Hamilton Street, Ottumwa, Iowa. Phone 2691.

Have 72-inch R.C.A. Victor exponential horn, with electric and acoustic tone-arm pick-ups. First check \$25.00 takes it. Crossman air gun, 22 calibre shoots like a regular bullet rifle, cost \$17.50—will sell for \$7.00. H. Ackerson, Island Road, Ramsey, N. J.

Stewart-Warner 8-tube broadcast set, table model No. 801B, original price \$89.50. Will sell for \$12.00. Rembert Short Wave Converter, 3 tubes, with power supply and automatic switching arrangement, 10 to 200 meters, brand new, never used, cost \$25.00, will sell for \$7.50. Zenith model ZE220 chassis, 36 in. long, 10 tubes, T.H.P., slightly used, including tubes, equipped with two horns, comes with model ZE1 battery eliminator, with Raytheon tube, also Westinghouse Rectox trickle charger, original price \$500.00, will sell for \$40.00. A. Ribarsky, 180 Riverside Drive, New York City.

One television scanner comprising synchronous motor, 60 hole scanning disc, first come, first served, \$7.00. Ellis Ackerson, North Central Ave., Ramsey, N. J.

ULTRA-MODERN SUPER. All parts for this famous set mounted on a cadmium-plated chassis and partly wired, for sale. Only manufactured parts used; everything in excellent shape. Set described in October issue of this magazine. Price, \$20.00. A real buy. Z. Martin, 415 Lefferts Ave., Brooklyn, New York.

Complete sound advertising system, for automobile. Excellent condition. H. C. Zeis, 1910 South Wayne St., Auburn, Indiana.

The Best NEWS of the Year will be found on the Inside Back Cover of this issue

time to check the original setting, making any changes necessary with resistor R2 to maintain this setting.

The tuning meter is rapid in action and the inclusion of the checking switch, PB, obviates the necessity for shorting the pin jack terminals as in many designs. The rapidity with which the voltage scales can be changed makes it exceptionally handy, and since it is completely self-contained, it may be plugged into a 110-volt 60-cycle line anywhere. This makes a very compact instrument for the measurement of any voltage, A.C. or D.C., from 0.1- to 200 volts.

It must be remembered that this meter reads the peak voltage, and when used on A.C., the result must be multiplied by .707 to obtain the rms voltage which is generally specified.

Because of its compactness and ease of operation, this V.T. voltmeter has a great many uses. It may be arranged with a double pole, double throw switch to read both the input and output voltages of an audio amplifier. The characteristics of the amplifier can then be obtained by feeding a few tenths of a volt input from a variable audio oscillator and checking the output voltage. This is only one of the many uses to which such an instrument may be put, and the author leaves it to the experimenter to find others.

(The May, June, and August, 1932, and the January, 1933, issues of RADIO-CRAFT contain a series of articles on the uses of the V.T. voltmeter. This series covers most of the applications that are to be found in routine laboratory and service work.—Editor.)

List of Parts

- One Clarostat 7,500-ohm tapered potentiometer, R1;
- One Clarostat 1,000-ohm volume control, R2;
- One I.R.C. 4,000-ohm, 2 watt resistor, R3;
- One I.R.C. 100 to 1,000, 2 watt resistor (to be adjusted until the plate-voltage equals 90, R4);
- One I.R.C. 1 megohm grid leak, 1 watt, R5;
- One Lynch 2,000-ohm resistor, R6;
- One Lynch 10,000-ohm resistor, R7;
- One Lynch 100,000-ohm resistor, R8;
- One Lynch 300,000-ohm resistor, R9;
- One .25-mf. tubular condenser, C1;
- One .5-mf. tubular condenser, C2;
- Three 4 mf. dry electrolytic condensers with cardboard cases, C3, C4, C5;
- Two I.C.A. S.P.S.T. toggle switches, Sw1, Sw4;
- One push button, type 2003L, S.P.D.T. locking type, Sw.2;
- One rotary tap switch, 4 positions, type 1614, Sw.3;
- One push button switch, type 2003, S.P.D.T., PB;
- One power transformer, 600 volts with center tap, 40 ma., with one 5 and one 2.5 volt windings, T;
- One filter choke, 30 henries, 50 ma., CH;
- One 5-prong socket, type 85, V1;
- One 4-prong socket, type 84, V2;
- Three tip jacks, two red and one black;
- One Readrite type TM-108, 0 to 5 ma. tuning meter with pilot light, TM;
- One 0 to 1 ma. 1,000-ohm-per-volt milliammeter, V;
- One type 56 tube;
- One type 80 tube.

50 CENTS A CALL

We received an interesting comment from one Service Man who claimed that so much varied test equipment must be used these days that a trailer is necessary.

Perhaps we had better get after our advertising department for trailer advertising.

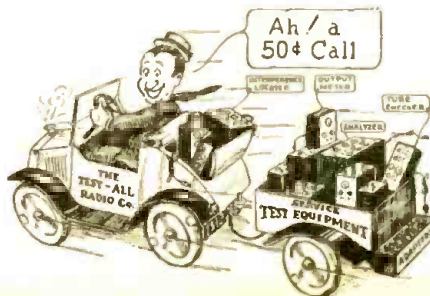

Best SELECTION Lowest PRICES Quickest SERVICE

Better get on our list - It Will Pay You to Send Coupon

RADOLEK CO., 127 Canal Station, Chicago. Gentlemen: Please send me the Profit Guide. I am a Dealer Serviceman I operate from Shop or Store from Home

I own the following Test Equipment.....

My training and experience is.....

Name.....
Address.....

RADOLEK RCA INSTITUTES

Recognized Standard in Radio Instruction Since 1908

Technical Training Courses in Radio and Associated Electronic Arts

- Practical Radio Engineering
- Sound Engineering
- Broadcast Transmission
- Radio Servicing
- Commercial Radio Operating

Resident Schools at New York and Chicago

EXTENSION COURSES for HOME STUDY under new "no obligation" plan, with privilege upon graduation of 2 weeks' intensive practical training without charge at either Resident School.

Mail Coupon for Illustrated Catalog

RCA INSTITUTES, INC.,
Dept. RT-7
75 Varick Street, New York, N. Y.
1154 Merchandise Mart, Chicago, Ill.

Please send with no obligation to me:
() Illustrated catalog and information about resident school courses.
() Information about extension courses for study at home, together with illustrated catalog.

Name..... Age.....
Address.....
City..... State.....

New! UNIVERSAL MODEL "E" Condenser Type Microphone

Amazing quality at a sensationally low price. 90° Swivel Head with Automatic Barometric Adjustment—2-Stage Amplifier—Non-Microphonic Tubes—Solid Bar Grating Diaphragm Protection—Polished Aluminum and Chrome Plated—A. dealers' net cost of \$54.00, this is by all odds the greatest value in microphone history.

UNIVERSAL MICROPHONE CO., Ltd.
424 Warren Lane
INGLEWOOD, CALIF., U. S. A.



FILTERIZERS

lick your worst enemy

MAN-MADE S·T·A·T·I·C

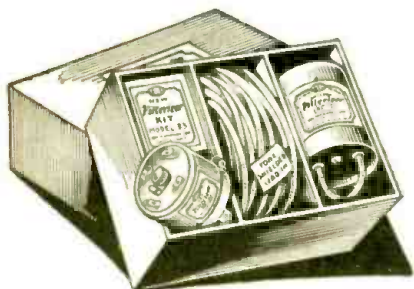

The TOBE FILTERIZER KIT, as shown above, and easily installed, as shown below, STOPS ALL RADIO NOISES

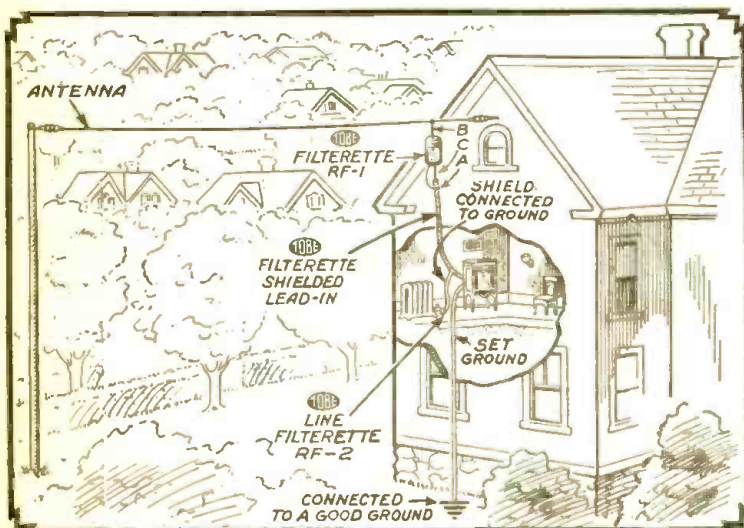

Special Offer to Dealers and Service Men

Your sample Filterizer Kit is now ready at an introductory price of \$2.75. Just attach this coupon to your letterhead with your check or money order, including 15 cts. for postage, and we will send one only Filterizer Kit, complete with one antenna Filterette RF1, 75 feet of Filterized lead-in wire, and one RF4. This offer expires July 31, 1933. Positively no orders filled at that price after expiration date. (Regular list price \$4.65.)

NEWARK ELECTRIC COMPANY,
226 West Madison St., Chicago, Illinois.

Enclosed find \$2.75 (plus 15c for postage) for which send me at once one SAMPLE FILTERIZER KIT, as per your advertisement.

Name

Address

City..... State.....

Here IT is! The "Something to put on the radio set" that dealers and Service Men have been looking for ever since eruptions of man-made static began spoiling receiver sales.

The Tobe Filterizer Kit keeps radio noises out of the receiver by the simple method of filtering the power input to the set, providing an aerial outside the field of radio noise, and carrying broadcast signals to the receiver thru a *Filterized* lead-in system.

To any receiver — anywhere — add the Tobe Filterizer. The result—instant relief from man-made static.

Everyone wants relief from radio noise. The Filterizer provides this relief. Tobe's greatly increased appropriations for consumer advertisement give you additional assurance of a tremendous demand for this sensational *new* development. Don't be caught napping. Place your sample order today for immediate delivery.

NEWARK ELECTRIC CO.

DISTRIBUTORS of TOBE PRODUCTS

226 WEST MADISON STREET,
CHICAGO,
ILLINOIS



BOOK REVIEW

HIGH-FREQUENCY MEASUREMENTS, by August Hund. Published by the McGraw-Hill Book Co., Inc., New York, N. Y. First Edition, 6x9 inches, 491 pages, 373 illustrations, cloth. Price, \$5.00.

A very excellent book for any one interested in obtaining data on high-frequency measurements. The book starts with a discussion of the fundamental relations in electrical circuits, followed by a résumé of high-frequency sources. Following this preliminary discussion, there is a complete and authoritative discussion of measurements. An interesting chapter is the one dealing with vacuum-tube measurements; this chapter brings out the methods agreed upon by the Standardization Committee of the I.R.E.

To any one interested in obtaining a comprehensive treatment of high-frequency phenomena, this book is recommended.

RADIO ENGINEERING HANDBOOK, by Keith Henney, Editor in Chief. Published by the McGraw-Hill Book Co., Inc., New York, N. Y. First Edition, 4½x7 inches, 583 pages, 482 illustrations, flexible Keratol cover. Price, \$5.00.

In all the years of broadcast radio many, many books have appeared which attempted to condense all of the various sections of radio between two covers. Invariably they have failed; they have failed simply because it is almost an impossibility for one man to have at his finger tips all the kinks that enter into each phase of radio. Keith Henney has solved this problem admirably by editing the numerous sections of the book; each section being written by an expert. Thus, the book is a compilation of the knowledge and experience of many experts and specialists.

The book is exactly what the name implies—a handbook. It is replete with curves, tables, formulas, all in condensed form for easy reference. The discussions are short, vital, and clear. In short, the book is intended for the man who needs information quickly, and who is not willing to wade through a maze of reference material.

No doubt this handbook will go far toward helping the practical man in a practical way.

STANDARD HANDBOOK FOR ELECTRICAL ENGINEERS, by Frank F. Fowler, Editor in Chief. Published by the McGraw-Hill Book Co., Inc., New York, N. Y. Sixth Edition, 4½x7 inches, 2816 pages, numerous tables, graphs, etc. Price, \$7.00.

Any one who has even glanced at the previous editions of the Handbook will appreciate the enormous amount of material that is covered.

The Last Word in TEST Equipment

ANALYZER UNIT

May be used with the Multimeter or any volt-ohm-milliammeter

Complete Knock-Down Kit with Diagram and Instructions..... **\$10.00**

FEATURES:

4-5-6-7-8-9 Prong sockets. Selector switches—11 points each—for resistance and voltage measurements. Provides spares for future—55 different voltage readings and 55 different resistance readings available at one socket. Grid shift test for all tubes. Automatic current selector switch. Six momentary push button switches for current measurement—protects meter. Ten wire analyzer cable with plug and complete set of adapters. Finely etched panel and crystalline finish case.

Complete Super Test Unit, Model 500, Wired and Assembled..... **\$13.00**

NEW TUBE TESTER

Complete Knock-Down Kit with Diagram and Instructions..... **\$13.00**

FEATURES:

4-5-6-7-8-9 prong sockets. Tests all new tubes without adapters. D'ARSONVAL TYPE MOVING-COIL METER. Tests 125 different types of tubes. GAS TEST. SHORT TEST with pilot light. 2nd plate test on all rectifiers. GRID BIAS TEST. Simple to operate and read. Beautiful etched panel with all tube numbers marked. Portable leatherette carrying case.

Complete Dependable Tube Tester Model 303 Wired and Assembled..... **\$16.00**

RADIO CITY PRODUCTS CO. 48 West Broadway New York, N. Y.

It is impossible to do justice to this book in a book review; it must be used to be appreciated.

The latest, sixth edition, is more than 30 percent larger than the fifth edition, every section is fully revised,—many are entirely rewritten—there are several chapters on thermionic vacuum tubes and circuits, and the book is more specialized. A thoroughly comprehensive treatment of electrical engineering.

THEORY OF THERMIONIC VACUUM TUBES, by E. Leon Chaffee. Published by the McGraw-Hill Book Co., Inc., New York, N. Y. First Edition, 6x9 inches, 652 pages, 357 illustrations, cloth. Price, \$6.00.

Since the appearance of Van der Bijl's *Thermionic Vacuum Tubes* some ten years ago, there has been no text that covered the vacuum-tube field. During the past ten years the changes in this field have been so rapid that any book that could be put out would have become obsolete before it came off the press. This field, now, is constant. True, new tubes are continually being announced, but the point is that the fundamental theory of operation is constant: a triode is still a triode, the screen-grid tube will always be a screen-grid tube, and the pentode will always have three grids—provided, of course, that the system of numbering used now is retained.

Chaffee's new book is easily one of the most comprehensive texts on thermionic vacuum tubes suitable for radio purposes that has ever been printed. It starts with a complete analysis of the electron theory as applied to vacuum tubes, and then leads into a detailed account of the action of tubes in radio. Detailed consideration

(Continued on page 57)

Dependable Sensational Performance!

5 DAYS FREE TRIAL

...BUD LOUD SPEAKERS

NORMAL efficiency 2½ to 25 watts —peak capacity 50 watts! BUD'S new diaphragm and voice coil assembly assure higher efficiency and far greater dependability! Write for literature on BUD units, all aluminum, weatherproof, "NATURAL-TONE" trumpets, microphones, exciters, air column horns. Get details of FIVE-DAY FREE TRIAL!

BUD SPEAKER CO.
1153 DORR ST.
TOLEDO, OHIO-U.S.A.

AUTOCRAT AUTO RADIO

6 TUBE

Quality—Tone—Selectivity and Power

List Price Complete \$29.40 —includes remote control, suppressor kit, tubes mounting brackets, dynamic speaker. Set only \$10.78. Also 4-5-6 Tube Midgets with latest tubes at low prices. Buy direct from manufacturer. Save up to 50%.

Autocrat Universal A.C.-D.C. 110 Volt 25-60 cycle, with latest Tubes 1-6D6, 1-6C6, 1-43, 1-25Z5, use Voltage Doubler Rectifier. Sensitive Selective. Dynamic Spkr. Walnut Cab. Compl. \$10.75

Write today for our free catalog

AUTOCRAT RADIO CO.

3855 N. Hamilton Ave. Chicago, Ill.

THE POSTAL KIT SET

(Continued from page 11)

are in a decorative walnut-finished cabinet measuring 11 inches long, 7 inches high, and 5 inches deep.

This outfit is available in both assembled and

kit form. The chassis is supplied already formed and drilled, and the parts may be mounted and wired with little trouble. Ignition suppressors and protective condensers are included.

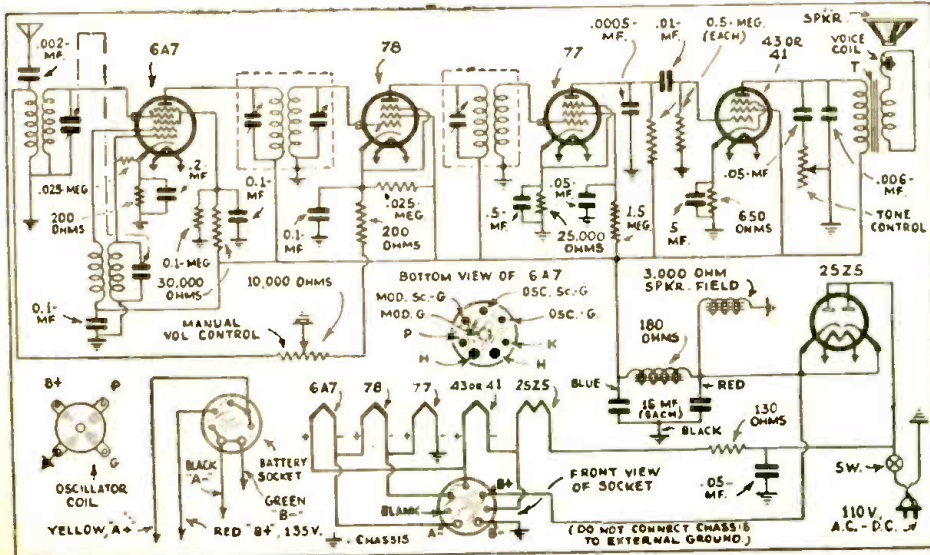

Schematic circuit of the Postal receiver.

FORDSON'S NEW LOW COST SUPER

30 DAY TRIAL

SIX TUBE Goldentone TRADE-MARK Superheterodyne

\$9.95

Six Tube Chassis and Dynamic Speaker

With automatic volume control using the new duplex diode triode type 55 tube and with Class A power pentode using the new seven-prong type 30 Pentode tube. **SEND FOR FREE CIRCULAR**

FORDSON RADIO MFG. CORPORATION
11700 Livernois Avenue, Detroit, Michigan.

Send the FREE circular giving complete details and prices on the GOLDENTONE radio.

Name.....
Address.....
City..... State.....

EASY WAY TO MAKE MONEY IN RADIO

New training method and service equipment offer starts you earning quickly. Covers all the latest developments in radio science, preparing you quickly and thoroughly for good positions or independent business career. Send NOW for all particulars to

Radio Training Association of America
Dept. RCA-7, 4513 Ravenswood Av., Chicago, Ill.

Service Men's Essentials for All Members of the

ORSMA



No. 11—50c each
(Plus 10c for Postage)

RADIO SERVICE SHOP
1117 Park Ave., N.Y.C.
Washington, D.C.
West 17th

Name _____
Address _____
Phone _____
Make _____
Type _____
Installation _____
Tubes _____
Parts _____
Labor _____
Solder _____
Tools _____
Special by _____
Sent by _____

This set-up operates to my entire satisfaction and above charges are O.K.
Signature of customer _____
Add your protection, get the "TOTAL" on above it, has been made for you.

No. 3—60c per pad of 50
\$3.00 per ten pads, each of 50



No. 5—50c each

Mail This Coupon Today!

Application for Membership in ORSMA

Executive Secretary, ORSMA
98 Park Place, New York, N. Y.
Kindly send an application blank for
 Full Membership
 Associate Membership

Name _____
Street or Box _____
City _____ State _____

SERVICE MEN'S ESSENTIALS

THE OFFICIAL RADIO SERVICE MEN'S ASSOCIATION has made arrangements to supply a number of "Service Men's Essentials" for the use of its members and associate members. Only members and associate members can buy these items; they are not sold to others.

These essentials are priced at cost, plus a small additional fee which is the only source of income that the Association has. No one obtains any profit or benefit, except the Association itself. Whatever profit accrues, is reinvested for the furtherance and enlargement of the Association.

By using the letterheads, billheads, etc., you present the business-like appearance to your customers, so essential to successful servicing. In addition, the Association has made arrangements with most of the prominent manufacturers to allow special discounts to members, providing ORSMA letterheads are used when ordering.

No. 1 ORSMA LETTERHEADS

These letterheads, shown on the right, are furnished with your name, address and telephone number, printed on excellent paper. They are sold in lots of 100 or multiples thereof, with a distinct saving for single orders of 1,000 or more. You would have to pay many times more if you ordered small lots from your local printer. Per 100, 90c; per 1000, \$3.00.

No. 2 ORSMA ENVELOPES

These are furnished to match the letterheads, printed with your name and address and seal of the Association. They go hand-in-hand with the letterheads and are usually ordered in the same quantity. Per 100, 60c; per 1000, \$3.00.

No. 3 ORSMA SERVICE RECORD CARDS

They serve a double purpose; whenever you complete a job you fill out the report, bill and hand it to the customer; this is the "loyal moment" to collect. By the use of carbon paper a permanent record is kept which is a valuable asset to your business. They are furnished with your name, address and telephone number. Per pad of 50, 60c; per 10 pads, each of 50, \$3.00.

No. 4 ORSMA INSPECTION LABELS

The label is to be filled in with the proper dates, and pasted inside the set or cabinet where the customer will see it. It is a continuous reminder to him that, when service is needed, he can call you again. This advantage is apparent. Per 100, 50c; per 1000, \$3.00.

No. 5 ORSMA LAPEL BUTTON

At the suggestion of many members a handsome lapel button bearing the name and emblem of the Association has been designed. It signifies to your fellow members that you belong to the same Association;—and in addition it gives your customers a better appreciation of the professional nature of your work. 50c each.

No. 6 ORSMA BUSINESS CARDS

These are furnished on a fine grade of paper in two colors with a blatter back. Thus they present an added incentive to your customers to keep them in a prominent place, where they will do the most good. They are printed with your name, address, and telephone and bear the official seal of the Association. Per 100, 75c; per 1000, \$4.00.

No. 7 ORSMA EMBOSSED STICKERS

Ideal for use in sealing packages, envelopes, etc., or for use on post cards. They give your letters or cards a professional aspect. They are sold in lots of 100 or more. Per 100, 85c; per 1000, \$6.00.

No. 8 ORSMA RUBBER STAMP

A handy addition to any member's equipment. The first line of the stamp bears your name and the second reads — Member, Official Radio Service Men's Ass'n. This stamp has many uses in the everyday life of a Service Man. 40c each.

Nos. 9 & 10 ORSMA EMBLEM CUTS

These cuts for printing, advertising, etc., are furnished in two styles and sizes. They may be used for newspaper or telephone-book advertisements or for printing of any kind. Large size, 1 1/2 x 1 1/4 in., 75c each; small size, 1/2 x 1/4 in., 60c each.

No. 11 ORSMA MEMBERSHIP SIGN

A set of three of these signs, printed on heavy cards, and having holes punched in order to hang in your office or store, and are sold to members and associate members. They are large enough so that they are quite prominent and the two tone effect makes a very attractive appearance. Set of three, 50c.

No. 12 ORSMA ADVERTISING DISPLAY SIGN

A two color sign printed in large letters with your name, address and telephone, with the seal of the Association. This sign is sold in quantities of 25 or more and is ideal for hanging in stores, offices, etc., for advertising purposes. Set of 25 cards, \$3.00.

No. 13 RADIO SERVICE MEN'S ASSORTMENT PACKAGE

This includes one gold filled lapel button, 100 letterheads, 100 envelopes, 50 service record cards, and 100 labels printed with your name and address as described above. The whole assortment costs only—\$1.00—a worth-while saving. Complete, \$3.00.

No. 14 ORSMA MEMBER CERTIFICATE

A handsome diploma-like certificate engraved on stiff vellum-bond. The certificate is personally signed by the President and Executive Secretary and the incorporation stamp of the Association is impressed on a red seal attached to it. Your name, certificate number and date of registration are lettered by hand and the Certificate is mailed in a cardboard tube to insure safe delivery. Each 50c, plus 10c for postage.



No. 1—60c per 100
\$3.00 per 1000

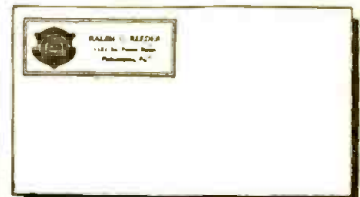

No. 2—60c per 100
\$3.00 per 1000



No. 6—75c per 100
\$4.00 per 1000



No. 4—50c per 100
\$3.00 per 1000

OFFICIAL RADIO SERVICE MEN'S ASSOCIATION

98RC Park Place, New York, N. Y.

Please send me the following RADIO SERVICE MEN'S ESSENTIALS which I have selected from this advertisement. My remittance for \$_____ is enclosed. Send remittance in form of check or money order. Register letter if it contains cash, currency or unused U. S. Postage Stamps.

.....
.....
.....
.....
Name..... ORSMA No.
Address..... City and State.....

Our Readers Say—

"The RADIO-CRAFT INDEX makes it easy to find the exact location of any article or topic which appeared in RADIO-CRAFT. Without any loss of time, you can locate quickly, the article needed. This book is a big help to every radio man."

The RADIO-CRAFT INDEX

It contains a thorough, alphabetical and topical arrangement of EVERY article and subject which has been published in all the issues of RADIO-CRAFT from July, 1929 to June, 1932

Radio Men have conclusively proved to us the need and practicability for a book which has included in it, a comprehensive and complete listing of every article which has thus far been published in RADIO-CRAFT. A book which has each topic so sub-divided and cross-indexed that a mere glance at a subject will give you any number of classifications and uses of it. For example, if you look at tubes, you find under this topic, various sub-titles, general, power, transmitting, photo-cells, testing of tubes, thyratons, etc. Every article or notice in the book has been considered so deeply important that when you refer to a certain classification, listed below the main topic, you will find perhaps a dozen or more articles treating the subject from different angles. The author in each case is given—the exact issue in which the article appeared, and on what page it is to be found. So accurately compiled, by C. W. Palmer, one of radio's foremost writers, that in less than two minutes you can turn to any article—needless to waste through all the issues of RADIO-CRAFT which have been published during the past three years.

The RADIO-CRAFT INDEX is exactly the same size as the monthly magazine—it has 24 pages. It can be conveniently kept on file with the copies of the magazine—ready for quick reference. The index is printed on good paper with self covers.

This book is sold only by the publishers at 25c the copy. Mail coupon below for your copy of the RADIO-CRAFT INDEX.

Briefly outlined below appears only a partial contents of the book

AMPLIFIERS—	PATENTS—
ANTENNA SYSTEMS—	PHONOGRAPH REPRODUCTION AND RECORDING—
CABINETS—	POWER SUPPLY AND BATTERIES—
CIRCUITS—	RECEPTION—
CODE—	REMOTE CONTROL—
COILS AND TUNING—	SELLING AND MONEY MAKING SERVICING—
COMPONENTS—	SET CONSTRUCTION—
COOPERATIVE LABORATORY—	SPEAKERS AND REPRODUCERS—
DETECTORS AND RECTIFIERS—	TELEVISION—
EDUCATION—	TOPE AND VOLUME CONTROL—
INTERFERENCE AND HUM ELIMINATION—	TOOLS—
KINKS—	TRANSFORMERS—
MANUFACTURING—	TRANSMISSION—
METERS AND TESTING EQUIPMENT—	TRANSMITTERS—
MISCELLANEOUS—	TUBES—
MOTION PICTURE RECORDING AND PROJECTION—	LIST OF BROADCAST SHORTWAVE AND TELEVISION STATIONS—
MUSICAL INSTRUMENTS—	
NEUTRALIZING—	
NOVELTIES—	

ABSOLUTELY NOTHING WHICH HAS APPEARED IN RADIO-CRAFT HAS BEEN OMITTED FROM THIS VALUABLE COMPILATION

Clip and Mail Coupon Today!

Publishers of RADIO-CRAFT, RC-733
96-98 Park Place, New York, N. Y.

Enclosed you will find my remittance of 25c (check, stamps or money order accepted) for which you are to send me, postage prepaid, one copy of the RADIO-CRAFT INDEX.

Name _____

Address _____

City _____

State _____

THIS BOOK CANNOT BE BOUGHT ON THE NEWSSTAND—ONLY DIRECT FROM THE PUBLISHERS **25c THE COPY**

BOOK REVIEW

(Continued from page 55)

is given to the rectification of small and large signals; a very complete chapter on regeneration is included; also, a much needed chapter on input and output admittances of vacuum tubes.

Every chapter is clear—as clear as only an instructor can make it. It is mathematical, instructive, and well worth reading.

ELECTRONICS, by R. G. Hudson. Published by John Wiley & Sons, Inc., New York, N. Y. Size 5 3/4 x 8 3/4 ins., 135 pgs., 45 illustrations, cloth. Price, \$2.00.

"It is quite probable that the advancement of science during the next quarter-century will relate more definitely to electronics than to any other subject. Each step in progress may be expected to suggest practical applications of electronic theory which will give man increasing control of the forces of nature.

"This book is written for the reader who may wish to know something about what is going on and who has not heretofore given the matter much attention."

The above quotation is from the author's Preface. "Electronics," a non-mathematical treatise, is invaluable.

MICROPHONES

By E. E. Griffin, Chief Engineer
Universal Microphone Company

One of the irritating topics in sound transmission that frequently bobs up to trouble technical men has been the confusion as to the resistance of microphones and microphone buttons.

Yet the explanations are not complicated.

In some cases the D.C. resistance is practically the same as the A.C. impedance, while in others it is entirely different.

Take the case of a microphone button in series with a 1 1/2 volt dry cell. Considering the D.C. resistance of the microphone as 200 ohms, we will have a current of 7 1/2 milliampères flowing in this circuit.

This value of 200 ohms D.C. resistance is also its approximate A.C. impedance. The alternating current impedance of a carbon microphone is not always its apparent talking resistance, but rather the ratio of the power absorbed by it to the square of the current flowing through it.

The general assumption is that A.C. resistance of a carbon microphone is about 80% of its apparent talking resistance.

In the case of a two button microphone, an entirely different condition takes place. We have one source of current, a single dry cell, and the two buttons of the microphone are in parallel. Thus the microphone presents a parallel circuit, each leg of which being 200 ohms the total overall resistance is 100 ohms, and thus with 1 1/2 volts of battery in the circuit a total current of 15 mils will flow.

Its actual D.C. resistance, as far as battery supply is concerned, will be 100 ohms. Its A.C. impedance, however, as connected to the primary of the microphone transformer is entirely different since the two buttons in relation to the transformer are connected in series, thus presenting some 350 to 400 ohms A.C. impedance.

In regard to the transformer, the microphone is now considered an acoustically driven A.C. generator, with an impedance of approximately 400 ohms, and thus the transformer in order to efficiently match this value must have a primary winding of approximately 400 ohms effective impedance and must be provided with a center tap to take care of the microphone's D.C. exciting current.

This condition is adequately taken care of in the Universal No. 1089, 0089 and 1152 transformers and for the single button microphone a number 0075.

Each of these transformers has an extremely low D. C. resistance, with comparatively high A.C. impedance, which insures flat frequency characteristics from well below 30 cycles to well over 12,000 cycles.

A GIVE AWAY

It has long been said that he who buys in quantity is able to take advantage of the liberal discounts usually given to those fortunate enough to have the cash to buy in quantities.

The Arco Tube Company is giving away a tube tester for every \$50.00 purchase of their tubes. This tube tester was described in the April, 1933, issue of this magazine, and may be referred to for more complete information.

Allied Radio

TODAY - as always - BEST

for SERVICE QUALITY PRICE



WORLD'S FAIR ISSUE

YOU NEED THIS CATALOG
... SEND FOR IT TODAY!

ALLIED RADIO CORP.

833 W. Jackson, Chicago
Please send me FREE the new WORLD'S FAIR Issue of your Dealers' Radio Catalog.

Name.....

Address.....

City..... State.....

Allied Radio

THE NEW SHALLCROSS A.C. UTILITY METER

No. 685



CAPACITY
.0005 Mfd. to 10 Mfd.

INDUCTANCE
.5 Henrys to 10,000 Henrys

RESISTANCE
25 ohms to 5 megohms.
A.C. voltage ranges
0-10-125-500-1000
1000 ohms per volt.

This instrument is very easy to build. The important parts required are a 1-milliamper A.C. (rectifier type) meter and the SHALLCROSS Resistor Kit No. 685 with meter scale.

Send 6c in stamps for Bulletin 685-P describing this useful test instrument.

Shallcross Mfg. Company
ELECTRICAL SPECIALTIES
700 PARKER AVENUE
Collingdale, Pa.

BIG BUYS

- R.C.A. Universal AC-DC receiver complete with 4 tubes.....\$10.95
- R.C.A. Lic., Super-het.. Universal AC-DC receiver with 5 tubes..... 13.95
- Standard Universal AC-DC receiver with 4 tubes..... 9.45

Free Booklet, Short Wave Sets, Kits, etc.

Fanning Radio Labs
377-87th St. Brooklyn, N. Y.

Sensitivity **SHURE** Tone Quality

MICROPHONES

TRADE MARK REGISTERED

SHURE BROTHERS COMPANY

Manufacturers-Engineers
S. N. SHURE, Pres.
337 WEST MADISON ST. CHICAGO, ILLINOIS

READERS' BUREAU

On this page are listed manufacturers' catalogs and booklets, chosen because they are of interest to readers of RADIO-CRAFT. You can obtain copies FREE by using the coupon below.

5. CLAROSTAT CONTROL HANDBOOK. A large 32-page book containing detailed specifications of volume controls, attenuators, constant-impedance controls, phonograph pickup faders, tone controls, line ballasts, rheostats, potentiometers and fixed resistors of various kinds, together with valuable circuit-design data. Contains many diagrams and charts, and a guide of replacement volume and tone controls for many commercial receivers. *Clarostat Manufacturing Company, Inc.*

6. MEASURING RESISTANCE BY THE DEFLECTION METHOD. The conventional method for the measurement of resistance involves the use of the Wheatstone bridge, a costly piece of apparatus. However, there are other methods which provide a fair degree of accuracy, enough for all practical purposes. The least expensive is the deflection method, which makes use of popularly priced milliammeters and fixed resistors. This bulletin describes the method completely, and should be very useful to Service Men and experimenters with limited meter equipment. *Shalleross Manufacturing Company.*

11. SUPREME INSTRUMENTS. Contains lengthy descriptions of the Supreme service instruments, including the AAA1 Diagonometer, which is five instruments in one, the model 90 analyzer, the model 40 tube tester and the models 60 and 70 oscillators. Interesting to the Service Man because it tells how his work is facilitated by ingeniously-designed test equipment that indicates the condition of an entire set in a few minutes. New test apparatus to take care of the new tubes is also described. *Supreme Instrument Corporation.*

19. A BAPTISM OF FIRE. Centralab fixed resistors are made by forcing a carefully calibrated resistance material through a plastic ceramic material, and then baking both under terrific heat. This booklet describes the manufacturing process in detail, and lists the advantages claimed for fixed resistors of this type. It is interestingly written and illustrated, and makes good reading. *Central Radio Laboratories, Inc.*

21. READRITE RADIO INSTRUMENTS. This sixteen-page pamphlet contains some valuable hints on the testing of electrolytic condensers, as well as descriptions of the full line of popular-priced Readrite instruments. Worth having. *Readrite Meter Works.*

76. THE COAST-TO-COAST "BROADCAST." The "Broadcast" is the Spring-Summer 1933 edition of a 100-page mail order catalog that is a veritable encyclopedia. Its listings are very varied, and run from soldering lugs to complete 100-watt public address amplifiers. Every article is well illustrated and described for the benefit of radio dealers and Service Men, for whom the volume is specifically intended. *Coast-to-Coast Radio Corporation.*

81. I. R. C. RESISTOR CATALOG. This sixteen-page catalog describes a very complete line of fixed resistors for radio purposes. It includes full performance characteristics, so that a Service Man or an experimenter with a particular requirement in mind can select exactly the right unit for his purpose. A section in the back contains valuable data on the conversion of milliammeters into ohmmeters and voltmeters, and on the extension of voltmeter and ammeter ranges. This catalog is well worth saving. *International Resistance Company.*

94. ELECTRAD PRODUCTS. The newest and latest catalog of Electrad products contains twelve pages and lists many types of fixed and variable resistors and five different kinds of amplifiers for public address purposes. The popular Truvalt resistors have been improved by the addition of insulating shields and heat radiating covers, and a number of new sizes have been added to the line. The catalog also contains some valuable data on the application of resistors to radio receivers, transmitters, amplifiers and sound systems, and suggestions on how to compute the value of resistors. A handy and useful catalog. *Electrad, Inc.*

96. TONE FILTERIZER AND CONDENSERS. The Tobe Deutschmann company is now catering to the Service Man with an extensive line of filter, by-pass and line condensers and radio noise eliminators. Their latest catalog, describing the complete line, has just come off the press. A full page is given to the new "Filterizer" noise eliminating antenna system, an item of particular interest to Service Men because of the money-making opportunities it offers. *Tobe Deutschmann Corporation.*

97. ARCO TUBE BULLETIN. A descriptive folder giving full technical characteristics on the complete line of Arco radio receiving and transmitting tubes, photo-electric cells, television lamps, hot and cold cathode tubes, cathode ray tubes, rectifiers and charger bulbs. This can be posted for easy reference. *Arco Tube Company.*

98. HOW TO USE NOISE REDUCING ANTENNA SYSTEM ON BROADCAST WAVES AND SHORT WAVES is the title of the latest booklet on this important subject. In addition to covering the theory, the practical application of the various noise-reducing systems available for broadcast and short wave use, is described also. *Lynch Mfg. Co.*

99. AMPERITE CHART. Service Men will find this chart very valuable, as it shows the correct Amperite line voltage regulator to use with any of several hundred different broadcast receivers. An accompanying pamphlet explains how overloaded condensers and resistors may be the cause of crackling noises and poor reception. *Amperite Corporation.*

100. WHOLESALE RADIO SERVICE CATALOG. The new Spring 1933 Wholesale Radio catalog contains 152 pages, and is probably the largest mail order catalog of its kind in print. It is exceptionally complete, and includes everything from soldering lugs to all-wave receivers. It is of value to dealers, Service Men and experimenters for reference and ordering purposes. *Wholesale Radio Service Co. Inc.*

101. WESTERN ELECTRIC TUBES. A want long-felt among amateurs in radio telephony is filled by a catalogue just issued by the Western Electric Company. The catalogue covers types of vacuum tubes produced by this manufacturer for use only by licensed amateurs in radio telephone transmitting equipments. In all, 27 tubes are described, running from the smallest or so-called "peanut" tube to the 276A, which has a maximum plate dissipation of 100 watts. *Western Electric Co.*

102. AMERICA'S OLDEST RADIO SCHOOL. This attractive 16-page catalog describes the various course of instruction available at the RCA Institutes, New York. Training is given in the following subjects: radio broadcasting, radio operating, radio servicing, and sound and public address work. *RCA Institutes, Inc.*

103. MILES PUBLIC ADDRESS SYSTEMS. A concise 8-page catalog listing microphones, loud speakers, power units, amplifiers, transformers and incidental accessories. *Miles Reproducer Co., Inc.*

104. WESTON STANDARDIZED SERVICE UNITS. This folder describes a complete series of standardized service units, consisting of an analyzer, tube checker, oscillator, volt-ohmmeter and capacity meter. The units are of uniform size and may be combined in single cases of various sizes, depending on the requirements of the Service Man. *Weston Electrical Instrument Corp.*

HUM ELIMINATION*

Because of cost requirements, lack of chassis space, and plate supply voltage limitations, the filter system for the power supply in compact transformerless a-c and d-c receivers must be small. As a result, troublesome hum is often encountered in these sets. However, a careful study of the receiver circuit and the arrangement of the chassis components will nearly always reveal a remedy for excessive hum.

Sources of Hum

The principal sources of hum in small receivers are:

1. The power supply system, in general, is the most common source of hum. The necessity of using low-capacity condensers and small filter chokes may result in ripple voltage high enough to cause audible hum.
2. The speaker-field coil is also a common source of hum. Ripple voltages in the speaker-field power supply are induced in the voice coil, causing objectionable hum.
3. The pick-up of stray electro-static or electro-magnetic fields is another source of hum.
4. The rectifier tube is sometimes the source of modulation hum. The signal voltage entering the set over the power line may be modulated with the rectified a-c output from the rectifier, and then re-radiated, causing hum in the set.
5. The filaments or heaters of the tubes may, under certain circuit conditions, occasion a small amount of hum due to the effects of the electro-magnetic fields produced by the a-c filament or heater supply.
6. In heater-cathode types of tubes, leakage between the heater and cathode, due to the high a-c potential difference between them, may sometimes cause hum.

The first two sources of hum mentioned are undoubtedly the most common and the most troublesome. A small amount of hum in small transformerless receivers due to these sources must be tolerated in order to obtain a small size and low-cost receiver.

Location of Hum Sources

The first step in the elimination of hum is naturally the location of its source. By shorting first the input and then the output of each stage successively, hum originating in any one stage can be isolated. If hum persists after the input to the last audio stage has been shorted, the source of trouble probably lies in the power-supply system. To determine if hum is due to ripple voltage in the speaker field, short the output transformer or the speaker voice-coil and note the results. Any hum which continues is due to ripple voltages in the speaker field.

Hum Elimination

HUM DUE TO POWER SUPPLY

There are a number of steps to be tried in the elimination of hum originating in the power-supply system.

1. In many cases, balancing both sides of the line to the chassis through condensers will materially reduce hum. The capacity of these condensers should be about 0.1 uf.
2. The use of each half of the 25Z5 to supply a separate load circuit will usually achieve a reduction in hum. The speaker field can be supplied from one plate and its cathode, and the plate voltage for the tubes can be supplied from the other plate and its cathode. In a few cases it may be found that this arrangement, due to other circuit conditions, causes hum. In such cases, the plates and cathodes of the 25Z5 should be operated in parallel.
3. In circuits which employ separate loads for the two halves of the 25Z5, an increase in the capacity of the condenser by-passing the speaker field may reduce hum. Of course, in sets using both plates and cathodes of the 25Z5 in parallel, the filter condenser and the condenser by-passing the speaker field are the same.
4. Perhaps the most effective, but also the most expensive, method of reducing hum due to the power supply is to increase the capacity of the filter condenser. The maximum permissible size and cost of the condenser must be taken into consideration when this is done. However, increasing the capacity of the filter condenser has the further advantage that an improvement in the regulation of the power supply will result.

*Courtesy, R.C.A.

(Continued on following page)

RADIO-CRAFT 5-104
Readers Bureau
96-98 Park Place, New York, N. Y.

Please send me free of charge the following booklets indicated by numbers in the published list above:

No.

Name

Address

City State

(Please check the following)

I am

(1) Service Man (2) Experimenter

(3) Dealer (4) Jobber

(5) Radio Engineer

(6) Licensed Amateur

(7) Professional or Amateur Set

Builder
This coupon will not be honored unless you check off your classification above.

● Index to Advertisers ●

A	
Aerovox Corporation.....	59
Airex Company.....	48
Alden Mfg. Company.....	50
Allied Radio Corporation.....	67
American Annex Hotels.....	62
Autoerat Radio Company.....	55
B	
Bud Speaker Company.....	55
C	
Central Radio Laboratories.....	47
Clark Instrument Company.....	47
Clarostat Mfg. Company.....	59
Classified Section.....	50
Coast-to-Coast Radio Corp.....	43
Concourse Electric Company.....	46
Connies Inn.....	62
Coyne Electrical School.....	1, 41
D	
Deutschmann Corp., Tobe.....	51
Dumont Electric Company.....	42
E	
Electrad, Inc.....	49
F	
Fanning Radio Labs.....	57
Fordson Radio Mfg. Company.....	55
G	
Grenpark Company.....	63
K	
Klek Sound Equipment.....	49
L	
L & L Electric Company.....	46
Leed's Radio Company.....	Back Cover
Leotone Radio Company.....	49
Lynch Mfg. Company.....	42
M	
M & H Mfg. Company.....	44
Mayflower Hotel.....	62
Miles Reproducer Company.....	44
Monte Carlo Casino.....	62
N	
National Radio Institute.....	4, 5
Newark Electric Company.....	6
O	
Ohio Carbon Company.....	44
P	
Polk & Co., R. L.....	48
Popular Book Corp.....	51, 52
Postal Radio Corp.....	49
R	
Radio City Products Company.....	55
Radio Components Mfg. Company.....	59
Radio Trading Company.....	63
Radio Training Association of America.....	55
Radolek Company.....	53
RCA Institutes, Inc.....	53
Readrite Meter Works.....	45
Royal Radio of New York.....	48
Hotel Royal.....	62
S	
Scott Radio Labs., Inc., E. H.....	3
Service Men's Sales Company.....	Inside front cover
Shalleross Mfg. Company.....	57
Shure Brothers Company.....	57
Smith & Co., Johnson.....	61
Supreme Instrument Corp.....	51
T	
Try-Mo Radio Co., Inc.....	46
U	
Universal Microphone Co.....	53
W	
West Side Y M C A.....	46
Westinghouse Elec. & Mfg. Co.....	43

(While every precaution is taken to insure accuracy, we cannot guarantee against the possibility of an occasional change or omission in the preparation of this index.)

5. It is sometimes possible to eliminate hum by introducing into some circuit an a-c voltage of equal value and opposite phase to the ripple voltage.

HUM DUE TO SPEAKER-FIELD SUPPLY

An adjustment of the hum-reducing coil on the loud speaker will usually result in a reduction of the hum to a satisfactory value. The number of turns on the hum-reducing coil should be approximately one-half the number of turns on the voice coil. The resistance of the hum-reducing coil should be low compared to that of the voice coil.

HUM DUE TO RE-RADIATION FROM RECTIFIER TUBE

Modulation hum in small universal sets frequently is due to the fact that the power lines carry the signal voltage into the rectifier tube. Here the signal voltage is modulated with the rectified a-c hum-voltage, and then, either re-radiated to the antenna, or to other circuits in the receiver.

A 0.05 to 0.25 uf. condenser across the power line will usually remedy this difficulty.

HUM DUE TO STRAY FIELDS

The pick-up by radio-, intermediate-, or audio-frequency circuits of stray electro-magnetic or electro-static fields may cause objectionable hum in the set. There are two steps to be tried in the elimination of this hum.

1. Hum originating in any stage usually can be effectively removed by the use of a filter in the grid, screen, or plate circuit of the stage, or stages, at fault. This filter should consist of a resistance of 10,000 to 250,000 ohms and a condenser of 0.05 to 0.1 uf. Naturally, it will be desirable to use the lowest value of resistance and capacity necessary to accomplish the desired results.

2. A re-arrangement of the chassis parts may sometimes be necessary to eliminate hum caused by stray fields. Parts and circuits carrying a-c voltages should be separated as far as possible from parts and circuits carrying signal voltages. Stray fields from the rectifier tube and filter choke will be picked up by the detector or audio-frequency tubes unless they are properly placed and separated. Any audio-frequency transformers should be kept away from a-c fields.

HUM DUE TO FILAMENTS OR HEATERS

The a-c fields surrounding the filaments or cathodes may sometimes cause hum due to their control effect on plate current. In sets where the heaters or filaments are operated in series, a rearrangement of the heater sequence may reduce hum. The heaters of the more critical tubes should be nearest the side of the line to which the negative plate-supply is connected. Usually the second detector is the most critical, then the mixer (first detector), then the output tube. Their heaters should be arranged in that order with respect to the negative side of the line. The heater of the rectifier should be next to the ballast resistor which is connected to the high side of the line.

In sets employing a voltage-doubler arrangement, the heaters of the most critical tubes should be connected to the side of the line terminating between the condensers of the doubler. Also, if the speaker field is used as a filter choke it should be placed in the negative side at the "B" supply to reduce the potential difference between the cathodes and heaters.

HUM DUE TO HEATER-CATHODE LEAKAGE

The severe conditions imposed upon tubes operated with their heaters in series across the line sometimes causes hum. The relatively high potential applied between the heaters and the cathodes may cause leakage currents of sufficient magnitude to cause trouble. To eliminate hum due to these causes, the following steps should be taken.

1. The heaters of the tubes which are most critical to hum should be placed next to the negative side of the line. Trying various arrangements of the series heater connection will result in a combination having minimum hum.
2. If a rearrangement of the heater series fails to give satisfactory results, it may be necessary to enlarge the by-pass condensers around the self-biasing resistors. Capacities up to 5 uf. are desirable in the detector and last audio stage. Usually, low-cost low-voltage condensers can be used.

In spite of the severe operating conditions imposed upon the tubes, troubles due to heater cathode leakage are being steadily decreased by improvements in the tubes themselves.



AD-A-SWITCH is the Emergency Control!

With a skeleton stock of CLAROSTAT AD-A-SWITCH Controls over 70% of volume control replacements can be handled.

because

- one control can serve either for plain or switch type—
- the shaft is completely insulated from the contact arm—
- the combined length of shaft (with the mounting bushings) is 1 1/4"—sufficient to take care of most requirements—
- Standard Ad-A-Switch Controls are available in all tapers and electrical characteristics.
- AD-A-SWITCH is recognized and adopted as the only emergency Control rendering maximum service with minimum investment.

A helpful VOLUME CONTROL and RESISTOR GUIDE is available upon request. "AD-A-SWITCH" was originated by Clarostat

CLAROSTAT Mfg. Co.
285-287 N. 6TH ST. BKLYN. N.Y.

ELIMINATES STATION NOISES
PURIFIES RECEPTION
SHARPENS TUNING

YOU CAN MAKE BIG MONEY by selling this remarkably efficient

Selectivity Intensifier and Inter-Station Noise Suppressor to every set owner you call on! Our Agents sell as many as 25 weekly. You make a \$1.00 profit on each sale! Installed in a Jiffy—No Wiring Changes necessary. Takes the place of complicated Wave Traps, Band-Pass Filters, Noise Eliminators, etc. Provides "Super-Hot" "DX" Bands and Razor-Edge Selectivity for any receiver. Brings in all distant programs. Acts as an efficient REMOTE VOLUME CONTROL and "SQUELCHER." Eliminates objectionable advertising announcements. Approved by Leading Set Manufacturers. Guaranteed. \$1.00 Complete, Postpaid. Send Cash or Money Order.

AGENTS & SERVICEMEN Make BIG MONEY—Sells on Sight Your Profit ONE DOLLAR per SALE

RADIO COMPONENTS MFG. CO. 63 West 24th St. N.Y.C.

LABORATORY SERVICE

For the Service man, experimenter, set builder, small and large manufacturer of radio and amplifier circuits, electronic musical instruments, and testing equipment. We have winding equipment for all types of coils and condensers. Replacement service a specialty. If you have troubles, tell them to us, we can solve them; see our advertisements in the May and June issues of RADIO-CRAFT. WE INVITE THE CORRESPONDENCE OF FOREIGN MANUFACTURERS. If it is radio or amplifier parts you want, we have them! If it is complete equipment you want, we have it; also, complete parts for super use—any frequency. All our products are absolutely guaranteed to be as represented in every respect.

RADIO RESEARCH LABORATORIES
Manufacturers, Designers, Consulting and Experimental Engineers
2019 California Ave., Ft. Wayne, Ind.
20 years in the electrical and radio field

World-Wide Two Tube Short Wave Receiver

12,500 Mile reception record easily finished. Tune from 15 to 200 Mc. Gets foreign broadcasts, police calls, airplanes, amateurs, etc. DIRECT! Complete KIT (no drilling) with clear instructions to build this remarkable 2 tube receiver. \$4.75 Dry cell or AC model. Send \$1.00. Balance C.O.D. Satisfaction Guaranteed!

\$4.75

Send for FREE Short Wave Catalog
HARRISON RADIO CO. Dept. R-7, 142 Liberty St. New York City

DEALERS & SERVICEMEN
FREE! Your copy of our Latest Bargain Bulletin IS READY.
Now Issued Monthly. Send for it today!
AIREX, 67 Cortlandt St., New York City

The Radio-Craft Library Series covers accurately every branch of Radio—and thoroughly, too

Presented on this page are the new books of the RADIO-CRAFT LIBRARY—the most complete and authentic set of volumes treating individually, important divisions of radio. Each book has been designed to give radio men the opportunity to specialize in one or more of the popular branches of the industry. The material contained

in these books will increase your knowledge; you will find them a real help in your work and they will contribute to your money earning capacity. Read these books during your spare time at home. The authors of these books are well-known to everybody. Each one is an expert radio man; an authority on the subject—each is thoroughly

familiar with the field which he represents. This is perhaps the first real opportunity that you have ever had to build a radio library of books that are authentic, right-up-to-the-minute and written so that they are easily digested and clearly understood. Mail coupon below for your books.

TO THE RIGHT WILL BE FOUND A SHORT RESUME OF EACH BOOK

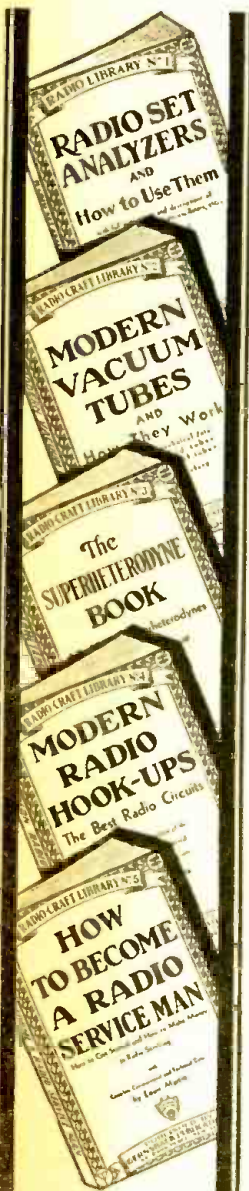

Book No. 1
Radio Set Analyzers

And How To Use Them
With Full Instructions and Descriptions of Set Analyzers, Tube Checkers, Oscillators, Etc.
By L. VAN DER MEL

This book explains thoroughly the operation of set analyzers, tube checkers, oscillators and other testing equipment. For every radio man this book is extremely helpful. It covers every valuable short cut; completely illustrated with photographs and diagrams to facilitate the use of modern testers. Recently reprinted.

Book No. 2
Modern Vacuum Tubes

And How They Work
With complete Technical Data on All Standard and Many Special Tubes
By ROBERT HERTZBERG

MODERN VACUUM TUBES describes the fundamental electron theory which is the basis of all vacuum tube operation, and goes progressively from the simplest two-element tubes right up to the latest pentodes and thyatrons. It is written in clear, simple language and is devoid of the mathematics which is usually so confusing. Valuable reference charts and characteristic curves of standard and special tubes are to be found, also diagrams of sockets and pin connections.

Book No. 3
The Superheterodyne Book

All About Superheterodynes
How They Work, How to Build and How to Service Them
By CLYDE FITCH

There is no more fascinating a subject in the large array of radio circuits than the famous superheterodyne circuit. Whether you are a Service Man or experimenter, first-hand knowledge about the construction of superheterodyne receivers is very important. The book on Superheterodynes gives underlying principles of their construction, right from the very first set made.

Book No. 4
Modern Radio Hook-Ups

The Best Radio Circuits
A Complete Compendium of the Most Important Experimental and Custombuilt Receivers
By R. D. WASHBURNE

It is fascinating to the experimenter, or even to the up-to-date Service Man, to take a commercial set and to change it into one using a famous hookup that is not found in any manufactured set. Many excellent circuits have never been commercialized, but limited only to home set builders. Thousands of these popular circuits have been requested from time to time, and in this book we have included over 150 circuits, which include the famous Peridyne, Cash-Box A.C.-D.C. Set and others.

Book No. 5
How to Become a Radio Service Man

How to Get Started and How to Make Money in Radio Servicing
By LOUIS MARTIN

The ambition of many men in radio today is to become a first-grade Service Man. It is not as difficult as one might believe, but it cannot be done in a few short months. Following very carefully the advice of Mr. Martin, who has dealt with the problems of thousands of Service Men, this book deals very carefully with the essential stages in the preparation for qualifying as a Service Man.

Book No. 6
Bringing Electric Sets Up to Date

With Pentodes, Multi-Mus, Dynamic Speakers—Complete Information How to Modernize A. C., D. C. and Battery Operated Receivers
By CLIFFORD E. DENTON

In this country there are over ten million electrically operated receivers that could be modernized—by placing in them new type tubes, new speaker equipment and other modern improvements. This business of improving old sets can go to the experimenters and Service Men if they will quickly jump into action.

Book No. 7
Radio Kinks and Wrinkles

For Service Men and Experimenters
A Complete Compendium on the Latest Radio Short-Cuts and Money-Savers
By C. W. PALMER

It often becomes necessary for experimenters and Service Men to call upon their memory for some short cut or radio wrinkle that will solve a problem quickly. In business, "short cuts" mean time and money saved, and to the Service Man "time saved" means money earned.

Book No. 8
Radio Questions and Answers

A Selection of the Most Important of 5,000 Questions Submitted by Radio Men During the Course of One Year
By R. D. WASHBURNE

There have been collected a wide variety of questions which have come into our editorial offices during the past two years, and only those whose answers would benefit the majority of men engaged in radio have been incorporated in this amazing question and answer book. A tremendously long list of topics is treated.

Book No. 9
Automobile Radio and Servicing

A Complete Treatise on the Subject Covering All Phases from Installing to Servicing and Maintenance
By LOUIS MARTIN

Automobile radios are up and coming, and someone has to service them properly. It therefore behooves you to read this immensely important new book on the art of Automobile Radio. This book is concise and full of illustrations, photographs, diagrams and hookups.

A few of the really interesting chapters: Introduction; Automobile Radio Installations; Complete Descriptions of Commercial Automobile Receivers; Servicing Automobile Receivers; The Ignition System; General Service Considerations; Effects of Temperature on Power Supply; Conclusion.

Book No. 10
Home Recording and All About It

A Complete Treatise on Instantaneous Recordings, Microphones, Recorders, Amplifiers, Commercial Machines, Servicing, etc.
By GEORGE J. SALIBA

If there is one subject that is fascinating to every radio man, it is that of Home Recording. Of course, this volume is not all on "Home" recording, but the information contained therein is important to commercial radio men, studio operators, engineers and others interested in this phase of radio.

The art of recording and reproducing broadcast selections is becoming more important every day to radio men, experimenters and Service Men. Equipping dance halls, auditoriums, churches, restaurants and homes with public address systems and amplifiers brings many extra dollars and often an excellent income.

Book No. 11
Point-to-Point Resistance Measurements

The Modern Method of Servicing Radio Receivers
By CLIFFORD E. DENTON

Of the difficult problems which Service Men face today when repairing receivers, the greatest is that of replacing proper resistance values in sets. This task becomes even more difficult when the values of resistors are unknown, and manufacturers of many standard sets do not pass this information on to Service Men. In this new book radio men will find the information needed to quickly place a receiver in normal operating condition. This book cuts in half the time usually required to adjust the average set. Sufficient space has been devoted to the elementary problems and the theory of electricity as it is applied to resistance measurements so that the Service Man will have a comprehensive idea as to how to overcome this problem. Below you will find a partial list of the contents which will appear in this new book.

INTRODUCTION. Advantages of Resistance Measurement Method of Servicing for Radio Work; Basic Principles; Methods of Resistance Measurement; Resistors in Radio Receivers and Amplifiers; Point-to-Point Resistance Measurements in Typical Radio Set using Ohmmeter; Resistance Measurements using Modern Tester; Routine Testing where Circuit Diagram is Available and where Resistances are Known; Routine Testing where Circuit Diagram is Not Available and where Resistances are Unknown; the Relation of Voltage Testkit Methods to Resistance Measurement; APPENDIX. Resistance Charts, etc.

ALL BOOKS UNIFORM

The books in the new RADIO-CRAFT LIBRARY are all strictly up-to-date, and written by men who know their subjects. The volumes are all uniform size, 6x9 inches, and contain on an average of 50 to 120 illustrations. Each book is printed on fine book paper and no expense has been spared to make it an outstanding value, for its editorial contents as well as from the mechanical standpoint.

Clip Coupon and Mail Today!

GERNSBACK PUBLICATIONS, INC., 96-98 Park Place, New York, N. Y.

I have circled below the numbers of books in the RADIO-CRAFT LIBRARY, which you are to send me, and have deducted 20% for ordering five (5) books or more. I have included my remittance in full, at the price of 50c each, when less than five books are ordered.

The amount of my remittance is..... (Stamps, checks or money orders accepted.)

Circle numbers wanted: 1 2 3 4 5 6 7 8 9 10 11

Name _____ Address _____

City _____ State _____ RC-7-33

Big Discount to You

In order to make it possible for everyone to buy these books, the fifty (50) cent price has been made uniform for all volumes. You can buy these books separately, but you should take advantage of our special offer:

When Five (5) Books or More Are Ordered

Deduct 20% from Your Remittance

Simply fill in the coupon at left, and mail it to us together with your remittance. Checks, stamps or money orders accepted.

Hotel Directory of the Radio Trade

The Hotels on this page are patronized by the Radio Trade. Make them your headquarters.

The Mayflower PLYMOUTH



On the Ocean at Manomet Point
One of New England's Finest Resort Hotels

Surprisingly Inexpensive

NEW LOW RATES
Smooth Sandy Beach . . . Surf Bathing . . .
Warm Sea Water . . . Swimming Pool . . .
Tennis Courts . . . Golf Course . . . On Hotel Grounds

UNDER SAME MANAGEMENT
MAYFLOWER HOTEL
HYANNIS

CAPE COD'S NEWEST HOTEL
CHARLES A. DOOLEY, MGR.

CAPE COD in MASSACHUSETTS



131st STREET & 7th AVENUE • N.Y.C.
TILLINGHAST 5 6630

ANNOUNCES

A NEW POLICY ALL YOU CAN DRINK

Week days \$2.00 Saturday and Holiday Eves \$3.00

Louis Russel's CONNIE'S INN ORCHESTRA

No
Cover
Charge



Same
High Class
Revue

HARLEM *at its* BEST!

BACK ISSUES of RADIO-CRAFT

which you might need to complete your files, can still be had at the price of 25c per copy. Send us your requirements, together with your remittance in check or money order.

RADIO-CRAFT 98 Park Place New York, N. Y.

In ST. LOUIS



THE
AMERICAN
HOTEL
275 ROOMS
WITH BATH
\$2.00 up

THE
ANNEX
226 ROOMS
WITH BATH
\$1.50 Up

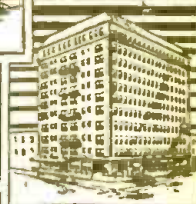

The
AMERICAN HOTEL
MARKET AT SEVENTH

The
AMERICAN ANNEX
MARKET AT SIXTH

Our Food has made
our Reputation
COFFEE SHOP OPEN
UNTIL MIDNIGHT

HELLO AMERICA!! IT'S HERE

New York's Most Sensational

Cabaret Restaurant

FEATURING **BETH CHALLIS**

RADIO (WOR) STAR

VAL VESTOFF
Vanities Dancing Star
ETHEL ALLIS
Danseuse de luxe
VITO & PIRI
European Novelty
MEDISCA & MICHAEL
International dancers

JOE HERBERT, Master of Ceremonies

in
BOBBY SANFORD'S
"WHEEL OF DREAMS"

40 World's most Glorious Girls 40
3 complete shows nightly—7, 12, 2:30 A. M.
SATURDAY MATINEE LUNCHEON
with complete revue 65 cents

Monte Carlo Casino

48th Street West of Broadway
Reservations—Lackawanna 7111
NO COVER CHARGE EVER

The Hotel Royal

The *HOMELIKE* Hotel of Philadelphia
at Broad St. & Girard Ave.
Philadelphia, Pa.

Combines every convenience and home
comfort and—commends itself to peo-
ple of refinement.

WITHIN 5 MINUTES OF CITY HALL

Rates as low as

\$1.50	\$2.00	\$2.50—Single
2.50	3.00	& up—Double

We make it our business to please

Ask for Mr. Smith, Mgr.

Victor 3 Stage High-Gain 7 to 20 Watt Output Victor Class "A" and Class "B" P.A. Amplifiers

Available in a Variety of 1933 Improved Models for Universal Operation from 6, 110, and 220 Volts AC or DC.

Excellent Adapted for Sound Truck Installations, Call Systems, Window Sales Demonstrations, Inter-Office Communication Systems, Lectures, etc.

We have made available this complete and extensive series of amplifiers, incorporating the latest type tubes to cover various modern innumerable amplifier applications.

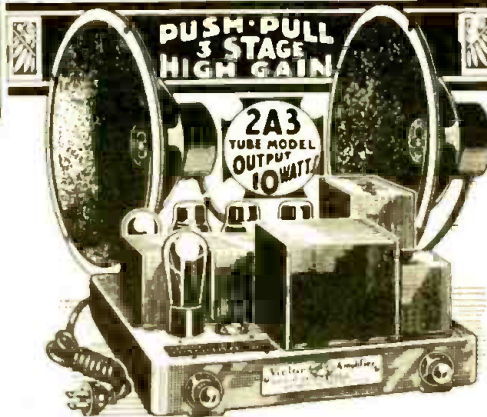

Additional Improvement of 3rd Stage Assures Maximum Amplification, Due to Its Highly Effective Use as a Powerful PRE-AMPLIFIER!

Every component part in these amplifiers was designed to carry a substantial over-load, to avoid break-down. Its generous construction can be gleaned by its dimensions of 13 1/2 in. long, 10 1/4 in. wide, 6 1/4 in. tall. Mounted upon a sturdy chassis, fitted with all conveniences, such as speaker field provision plug, Phono-Input Tap, voice coil outlet plug, tuner voltage outlets, etc., etc. The AC operated amplifiers can furnish DC Field Current to a 2,500 ohm Dynamic Speaker. (If you desire to use any other type speaker, we will include a special 2,500 ohm choke to supplant the speaker field . . . 90c additional.) You will be immensely thrilled by the almost uncanny reproducing qualities of these amazingly powerful amplifiers. We want you to expect the most, for you will not be disappointed!

The huge output obtained from these amplifiers together with their high-gain characteristics make them ideal for microphone, phono, or radio amplification. Specially designed and OVER-SIZED AC POWER TRANSFORMERS and auxiliary components assure life-long operation and trouble-free performance. To fully immortalize these amplifiers, both a TONE CONTROL and VOLUME CONTROL have been included. These remarkable amplifiers are supplied in COMPLETELY FACTORY ASSEMBLED form, and due to the self-explanatory connection diagrams furnished, any novice can quickly complete the very simple connections in order to make either of these amplifiers ready for operation. Highest grade parts make up these very easily assembled kits—most all of the units having been made by such manufacturers as Westinghouse, Victor, General Electric, etc., etc.

There is listed below a choice of UNIVERSAL MODELS for operation from any form of power, such as from 110 Volt AC, 2 VOLT AIR CELL installations, 110 Volt Commercial DC Lines. There is also available a special UNIVERSAL MODEL which may be operated from either 110 Volt AC-DC or from a Six Volt Storage Battery, driven motor generator. This latter model is ideal for use in SOUND TRUCKS, as it permits optional use from all AC-DC commercial lines as well.

CLASS "A" AMPLIFIERS

110 Volt AC 2A3 Models 3 Stage, 10 Watt Push-Pull Amplifier

SPECIFICATIONS: TUBES EMPLOYED: 2-56, 2-2A3, 1-52A; CIRCUIT: The first 56 Tube is resistance coupled into the second 56 Tube, which in turn feeds through a "PUSH-PULL" input transformer into the two 2A3 Output Tubes; GAIN AT 1,000 CYCLES: 84 DB; INPUT: For Phono, Pick-up and Double Button 200 ohm microphone, and Radio Tuner.
Complete Amplifier Less Tubes and Speaker \$13.95
SPECIAL OFFER: Above Amplifier Complete With Set of Genuine Matched Tubes and One 11-in. WRIGHT DE COSTER DYNAMIC SPEAKER. . . **\$23.50**
(Additional Speaker \$7.35)

2 Stage, 10 Watt Push-Pull Amplifier
TUBES REQUIRED 1-57, 2-2A3, 1-52A. **\$9.75**

110 VOLT A.C. CLASS "A" MODEL 3 Stage 7 1/2 Watt Pentode Amplifier

Available with choice of operation with following tubes: 1-56 (or 226, 227) 1st stage, 1-56 (or 226, 227) 2nd stage, 2-59 (or 2-47) 3rd stage. 1-280 or 83 rectifier.
7 1/2 WATT AMPLIFIER Less Tubes \$8.45
SPECIAL OFFER: Above Amplifier, Complete with set of Genuine Matched Tubes (specify type numbers desired) and one WRIGHT DE COSTER DYNAMIC SPEAKER. . . **\$16.45**

110 VOLT D. C. 48 MODEL 3 Stage 5 Watt Push-Pull Amplifier

TUBES REQUIRED: 1-237 (1st stage), 1-237 (2nd stage), 2-48 (3rd stage).
CLASS "A" AMPLIFIER Less Tubes \$9.75

CLASS "B" AMPLIFIERS

110 Volt A. C. 53 Model 3 Stage 10 Watt Push-Push Amplifier

SPECIFICATIONS: TUBES EMPLOYED: 1-57, 1-89, 2-53, 1-83; CIRCUIT: The first 57 is transformer coupled into a high gain 89 Pentode driver tube, which feeds through a special step-down parallel push-push transformer into the two 53 Dual Class "B" output tubes; GAIN AT 1,000 CYCLES: 86 DB; INPUT: For Phono, Pick-up, Double Button Microphone and Radio Tuner.
Complete Amplifier Less Tubes and Speaker \$18.95
SPECIAL OFFER: Above Amplifier Complete With Set of Genuine Matched Tubes and TWO 11 in. WRIGHT DE COSTER DYNAMIC SPEAKERS. . . **\$34.50**

TWO VOLT—49 MODEL 3 Stage 3 1/2 Watt Push-Push Amplifier

Tube Filaments are lit from a choice of Air Cell, 2 Volt Van Storage Battery, or Two Common Dry Cells. These current requirements: 140 volts 20-40 ma.
TUBES REQUIRED: 1-232, 1-231, 2-49. **\$7.25**

UNIVERSAL AC-DC MODEL Two Stage Push-Pull Amplifier

No Power Transformer Is Employed! Uses Two Voltage Doubling 25Z5 Rectifier Tubes on 110 Volts AC. Output on 110 Volts AC 5 WATTS. Output on 110 Volts DC 2 1/2 WATTS.

Tubes Required: 1-237, 2-43, 2-25Z5, **\$11.50**

Universally Operated 6 Volt D. C. and 110 Volt A. C. Amplifier System ACCESSORY POWER SUPPLIES

Designed for optional use with the 12 WATT Output 3 Stage Class "B" PUSH-PULL 79 Amplifier listed to the right.
110 Volt AC Power Pack Permits the complete operation of the 79 Push-Pull Amplifier from 110 volt A.C. Furnishes all necessary Plate and Filament Voltages. **\$18.75**
Storage Battery Operated Motor Generator Permits the complete operation of the 79 Push-Pull Amplifier from a 6 volt storage battery. Furnishes all necessary plate voltages. **\$17.50**

SIX VOLT—79 Push-Push Model

May also be completely operated from 110 volts AC with the special Power Pack illustrated to the left.
3 STAGE 12 WATT AMPLIFIER
TUBES REQUIRED: 1-237, 1-89, 2-79
Tube filaments are lit from a car storage battery or from dry cells. Plate current required: 140 volts at 65 to 115 ma which may be obtained from "B" Batteries or from the special 6 volt operated motor generator illustrated to the left.
AMPLIFIER LESS TUBES \$16.85

Additional Equipment Designed to Match Above Amplifiers

Allen Hough 110 Volt A. C. Phono. Motor

Only 1 1/4 in. thick. Revolves at an exact speed of 78 R.P.M. despite any voltage variations in Power line. 10 inch turntable included.
\$1.65

Nationally Admitted Phono. Pick Up

Extremely sensitive. Equipped with volume control.

EXTRA SPECIAL \$5.95

All-Purpose P. A. Amplifier "Mike-Phono-Radio" Control Unit

Permits any Volume of Microphone Speech to be Super-Imposed over Phono Record, or Radio Reproduction! Controls the Volume of Each One Independently! Ideal for Speeches with Musical Background, furnished by either Phono-Records or Radio Tuner.

A 0-25 milliammeter and rheostat are inserted into each microphone button circuit. Permits perfect current adjustment for each "MIKE". A special phono pick-up matched input transformer is self-contained. Black crystalline finish. 6x5 1/2 in. Only two wires need be connected to any one of the above amplifiers.
Equipped with Input Tone Control. . . **\$16.50**
Equipped with Input Tone Control. . . **\$19.50**
(Specify the impedance of the phono. pick-up and of the microphone to be employed.)

WRIGHT DE COSTER DYNAMIC SPEAKERS

Handles peak loads of up to 13 Watts—ideal for all P. A. Amplifiers. 11 inch Diameter. Withstands terrific volume. 4 1/4 inches deep. A husky size IMPEDANCE MATCHING OUTPUT TRANSFORMER is attached to the metal frame. The periphery of the cone is firmly staked to a flexible ribbed disc, and the voice coil (8 ohms impedance) will never go out of adjustment. Furnished with your choice of a 110 volt or push-pull output transformer. State Power tubes used.
DC Model with choice of 1,000 or 2,500 ohm field
DC Model for 6, 12 or 32 volt operation. **\$7.35**

Combination Model Equipped with TWO FIELDS
for 6 volt operation and choice of an additional 1,000 or 2,500 ohm field. Permits universal operation of amplifier or receiver from 110 volt AC or DC or 6 volt storage battery. **\$12.50**

Nationally Admitted 200 Ohm Double Button Microphone

Remarkably sensitive—covers wide frequency range. Actual worth, \$25.00!

Big Value \$5.25

Universal Combination Phono-Microphone and Radio Tuner

input Matching Transformer
Permits universal input applications from one transformer. Universal Phono-Pick-up. Both 200 and 500 ohms, as well as 3000 ohms and Microphone (Single or Double Button 200 ohm) Transformer. **\$1.95**

Universal Output Transformer 15 Ohm Secondary, Tapped at 8, 4, and 2 Ohms . . . **\$2.75**

All offers are F. O. B. New York, and subject to prior sale. Terms: A deposit of 20% is required with every order. Balance may be paid on delivery. Or, deduct 2% if full amount is sent with order.

GRENPARK CO.,

Dept. RC

**245 GREENWICH STREET,
NEW YORK,
N. Y.**

JULY SPECIALS!! No One Undersells Us!

EVERY month we list on this page certain STAR * items, which are NOT LISTED IN OUR CATALOG. These are all specials of which the quantities on hand are not sufficient to catalog them. Once sold out, no more can be had. First come, first served. ORDER NOW, TODAY.

STOP SHOPPING. The lowest prices are right on this page. No one undersells us. We meet any price on ANY NEW Merchandise. Order direct from this page and save money. 100% satisfaction on every transaction. Take advantage of these special offers. ORDER NOW, TODAY.

Only \$10.85

Greatest Buy In America!

Only \$10.85

★ "PEERLESS" 7-TUBE SCREEN-GRID T.R.F. RADIO RECEIVER

Complete with Full Dynamic Speaker

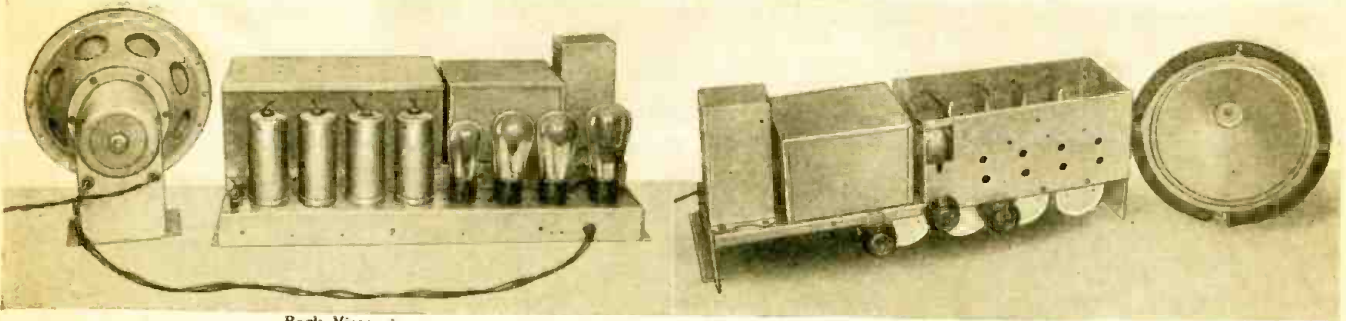

Back View

Front View

Limited Supply—Only as Long as They Last—Order Today

IF EVER there were a greater value than this offered before, we have yet to see it. The selectivity and sensitivity of this 7-tube receiver due to its three tuned stages are just as sharp as those of an expensive 11-tube Superheterodyne receiver. The construction of this receiver is best described as "standard." Its circuit is none other than the "good old standby" TRF type which is the most reliable and the most foolproof ever designed. It incorporated two stages of tuned R.F. amplification using type 24 Screen-grid tubes; the power detector is a 24; a single stage of AF voltage amplification utilizing the type 27 tube, feeds a 247 super-power pentode, the full wave rectifier is an '80. All provisions are made for supplying field power for the 9 inch genuine Magnarox, fully shielded full dynamic speaker. Both cone and spider of this excellent reproducer are made of Burtex to improve the high note response (brilliance) without impairing the low note production.

Tuning is extremely simple, the tuned circuits being controlled by a single central knob; a vernier drum-type illuminated tuning dial is employed. The second knob controls the on-off switch and the third, the one on the right, volume control. Coils, tuning-condenser-gang, filter condenser bank, output choke and by-pass condenser bank are all individually shielded. The chassis itself is made of non-magnetic aluminum.

The use of three tuned circuits, employing screen-grid tubes and high gain R.F. transformers, together with careful wiring, and by-passing, result in high sen-

sitivity. Many of our satisfied customers inform us that a good variety of distant stations come in like locals. Tone quality, too, is extraordinarily fine. Despite the maze of new tubes recently thrown upon the market, it is generally conceded that for average home use a single 247 pentode supplies adequate power with the least distortion.

Why build a set when a complete receiver, wired and ready to use, and complete with speaker, can be bought at this phenomenally low price? Here is an excellent opportunity for wide-awake service men to "clean up." There are little more than 100 of these receivers left and at this low price, they are bound to give out in very short order. Experimenters will find in this chassis the laboratory "monitor" they have been waiting to buy "when things got cheaper." Remember that the supply is limited. Hence, "first come, first served." The moral is don't delay, order today. Overall size 21" x 8" x 8 1/2" (set only). Ship. wt. 45 lbs.

List Price \$75.00

NO. SP-2000 Peerless 7-Tube TRF Receiver
YOUR PRICE with speaker but less tubes..

\$10.85

LIMITED SUPPLY—ORDER TODAY—TOMORROW MAY BE TOO LATE

★ A TREMENDOUS BUY!

U. S. Navy Airplane-Type Transmitter and Receiver

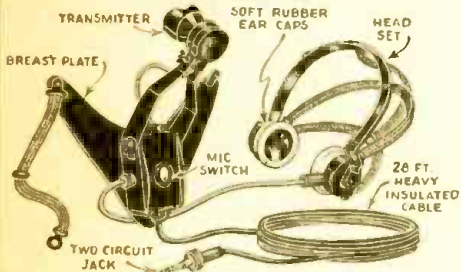

Only 300 at this Unheard-of Price

This microphone and headset outfit was built especially for the U. S. Navy Aviation Corps for plane-to-plane and plane-to-ground communication. Constructed under rigid governmental supervision.

The outfit consists of a low-impedance carbon transmitter securely fastened to a metal breastplate and a set of heavy-duty, low-impedance earphones provided with soft rubber cushions. A specially constructed switch on the back of the breastplate, controls the microphone circuit. Twenty-eight feet of heavy conductor cable, terminating in a special brass plug, is furnished complete with this outfit.

The U. S. Government probably paid more than \$30.00 for each of these outfits. Yet, a fortunate purchase permits us to sell them to you at \$1.95, COMPLETE, as shown in the illustration above. There is no question but what considerable use can be found for these delicate, yet sturdily constructed instruments. Ship. wt. of entire outfit, 7 lbs. List Price \$40.00.

No. B7216 U. S. Navy Airplane-Type Transmitter and Receiver. **\$1.95**

Doerle 12,500 Mile Short-Wave Set

Although the Doerle is a low-priced receiver, yet it pulls in short-wave stations from all over the world. REGULARLY, in practically any location, not only in this country, but *anywhere*. Thousands of experimenters have built their own, and have obtained miraculous results. All the usual "bugs" have been ironed out by us in such a way that you may order every receiver with full confidence, that "it will do its stuff" anywhere. It is possible for us to sell cheaper parts for the complete receiver at a lower price. But then we could not guarantee its performance. Therefore only First Class Material Is Used.

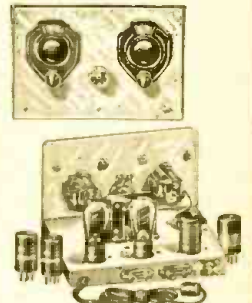

This receiver is exactly as illustrated. Size of aluminum panel is 9 x 6 1/2 inches; base 9 x 6 1/4 inches. List of material used: 2 Hammarlund .00014 Condensers; 1 Carter 20 ohm Rheostat and Switch; 1 standard Audio Transformer; 2 Kurtz-Kaseh Vernier Dials; 3 Bakelite Low Loss Sockets; 1 Micamold Equalizer; Antenna Condenser; 1-.0001 mica Fixed Condenser; 1-5 mekohn Carborundum Grid Leak; 2 Telephone Pin Jacks; 1 Aluminum Panel; 1 Vener Baseboard; 1 Bakelite Rheostat Knob; 2 double binding posts; 1 set of 4 Low Loss Short Wave Plug-in Coils; 4-page instruction pamphlet and blue prints; 1 Set of Hardware, Wire, etc. Complete shipping weight 5 lbs. No. 2141, TWO TUBE 12,500 MILE DOERLE SHORT-WAVE RECEIVER, completely wired and tested as per above specifications.

YOUR PRICE **\$8.90**

No. 2141, TWO TUBE 12,500 MILE DOERLE SHORT WAVE RECEIVER KIT, with all parts as specified above, but not wired, with blueprint connections and instructions for operation. Complete shipping weight 5 lbs.

YOUR PRICE **\$7.70**

No. 2142, COMPLETE ACCESSORIES including the following: 2 six months guaranteed Neontron type No. 230 tubes; one set of No. 1678 Brandes Matched Healphones; 2 No. 6 standard dry cells; 2 standard 45-volt "B" batteries. Complete shipping weight 22 lbs.

YOUR PRICE **\$5.40**

FREE RADIO AND SHORT WAVE TREATISE



Avail yourself now of the opportunity to receive the FREE 1933 Edition of our Radio and Short Wave Treatise—104 solid pages of useful information, radio items, diagrams and illustrations. Positively the greatest book in print—NOT JUST ANOTHER CATALOG. Contains a large editorial section with valuable information not found anywhere else. Special consideration has been given to the radio beginner in this issue. Among the new technical information listed are the following:

HERE IS A PARTIAL LIST OF CONTENTS

Fundamental Principles of Radio—Ohm's Law—Discussion of New Tubes—Constructing a "Triple-Twin" Amplifier—All about Superheterodynes—Eliminating Man-Made Static—Constructing a Two-Tube Short-Wave "Globe-Trotter" Receiver—\$3.00 Prize Suggestions—Radio Knobs, etc., etc.

WRITE TODAY. Enclose 4 cents for postage. Treatise sent by return mail.

Over 100 New Hook-Ups, Etc. 1000 Illustrations.

WE ARE A WHOLESALE HOUSE AND CANNOT ACCEPT ORDERS FOR LESS THAN \$3.00. If C.O.D. shipment is desired, please remit 20% remittance, which must accompany all orders. If full cash accompanies order, deduct 2% discount. Send money order—certified check—U. S. stamps.

Radio Trading Co.
102 Park Place
New York, N. Y.

ORDER FROM THIS PAGE. You will find special prices from time to time in this magazine. Get our big FREE catalog for the greatest Radio Bargains.

Should you wish goods shipped by parcel post, be sure to include sufficient extra remittance for same. Any excess will be refunded.

ANNOUNCING THE 1934 OFFICIAL RADIO SERVICE MANUAL

This new manual has been in actual preparation for several months. The vast amount of important data, which we have received from manufacturers who are assisting us in the compilation of the book, leads us to believe that the 1934 Manual will be more valuable than any previous editions.

THE necessity of GERNSBACK Manuals in the radio field has been shown by the fact that the total sales of the first three OFFICIAL RADIO SERVICE MANUALS, including the new CONSOLIDATED EDITION, now exceed 80,000 copies. Radio Service Men and others engaged in various branches of radio know the importance of such books, and how they must depend upon them for reliable information. Whether for public-address work, tube information or a circuit diagram, the material needed is certain to be found in one of the OFFICIAL RADIO SERVICE MANUALS. The GERNSBACK Manuals have been constantly used in reference work by leading radio set manufacturers, mail-order houses, jobbers, dealers and, most extensively, by Service Men, for whom these books are invaluable.

In the planning of the 1934 OFFICIAL RADIO SERVICE MANUAL many things have been taken into consideration. First, how we could reduce our own costs, and in turn pass these savings on to our readers. Second, what information not contained in previous editions of the Manuals must be incorporated in the 1934 edition and would be of utmost importance to its users. Third, what advance information we could print that would be useful in the future.

After careful analysis we found that the total cost of producing the 1934 Manual would be considerably less than in former years, and that at this time we could reduce the price of the book to our readers. The Fourth Edition of the OFFICIAL RADIO SERVICE MANUAL will sell this year for \$3.50. The book will be published like the 1933 Manual—the volume will be sent to you complete. BUT, AS USUAL, WE HAVE A PRE-PUBLICATION OFFER WHICH ENABLES YOU TO BUY THIS BOOK NOW, AT A CONSIDERABLE SAVING. The special price at which you can buy this volume is \$2.50. THIS IS A REDUCTION OF 50%, IN COMPARISON WITH THE PRICE OF LAST YEAR'S MANUAL. It pays to order your copies now!

Anticipating such information as may serve future radio needs, we are holding

many pages of the Manual open until the very last minute. Any timely "dope" which we then receive will be included before going to press.

In preparing this new edition many of the outstanding problems of the Service Men have been considered—methods of servicing, the new equipment constantly

As in previous years, the 1934 Manual will also include a FREE QUESTION AND ANSWER SERVICE. In each book will be found 25 coupons, which entitle you to free consultation on any radio service topics. These coupons give you a complete mail service—questions on servicing and operating on any set or circuit are answered promptly and accurately by the editors. Remember that, at the regular rate of 25c per question which is usually charged by radio magazines, this service alone is worth \$6.00. And for the Manual, we charge only \$2.50 at the pre-publication price.

It is quite evident that the 1934 Edition of the OFFICIAL RADIO SERVICE MANUAL will be a decided improvement over previous volumes, and will even surpass the high standard of the former Manuals.

SPECIAL OFFER FOR LIMITED TIME ONLY

In extending this privilege to our readers so that they may save by taking advantage of the low price of \$2.50 which is the pre-publication offer, we have decided that the opportunity should be open only until the 15th of July, 1933. YOU SAVE A FULL DOLLAR BY SENDING YOUR ORDER TODAY. The book, as usual, comes to you post-paid and free of all additional charges.

No need to delay sending us your order—the 1934 MANUAL, like its predecessors, is a necessity in your business. We strongly advise you to order your copy today, and then you will be certain to get one from the first printing of the book. The 1934 Manual will be ready in about eight weeks. Mail the coupon today.

Contents of the 1934 Manual in Brief

- Diagrams and service notes, more complete than ever before in any MANUAL. Not merely the schematic hook-ups will be found, but also chassis drawings showing parts layouts, positions of trimmers, neutralizers, etc.
- Voltage readings for practically all sets, as an aid in checking tubes and wiring.
- All values of intermediate-frequency transformers used in super-heterodynes, with the manufacturers' own suggestions as to correct balancing.
- Detailed trouble-shooting suggestions and procedure as outlined by the manufacturers' own engineers—in other words, authentic "dope" right from headquarters.
- Values of all parts indicated directly on all diagrams. WE WILL POSITIVELY NOT INCLUDE DIAGRAMS FOR WHICH PARTS VALUES CANNOT BE OBTAINED.
- A special section for reference to A.C.-D.C. cigarbox midgets.
- A special section for reference to automobile radio.
- A special section for reference to public-address amplifiers.
- A special section for reference to short-wave receivers.
- A special section for reference to remote-control systems.
- A complete compilation of radio tube data, covering both the old and the many new types.
- A special section devoted to test equipment, analyzers, etc., with full diagrams and other valuable information.
- A complete list of American broadcast stations with their frequencies in kilocycles; extremely useful in calibrating and checking test oscillators and in calibrating receivers.
- Free Question and Answer Service, the same as in our last two Manuals.
- No theory; only service information in quickly accessible form.
- Absolutely no duplication of any diagrams; nothing that appeared in any of the previous Manuals will appear in the 1934 MANUAL. This we unconditionally guarantee.
- A handy, easily-consulted master Index making it easy for you to find almost anything pertaining to your service problem instantly. This index will include all the diagrams published in all the previous GERNSBACK Manuals, as well as the 1934 diagrams. A big convenience and time saver!

needed to cope with new tubes and sets, and the other fields of radio, such as public-address systems, short waves, auto radio and others.

The illustrations in the 1934 Manual will be more explicit than before; inasmuch as the diagrams will not be limited to the schematic circuit, but other illustrations will show the parts layout, positions of trimmers, neutralizers, etc. There will be hundreds of new circuits included, and not one from any previous edition of the manuals will be repeated. *This we unconditionally guarantee.*

The number of pages in the new Manual will exceed 400, with hundreds of illustrations, including diagrams, charts, photos, picture layouts, etc. The size of the Manual will be the same as that of the former volumes—9x12 inches, with a flexible, loose-leaf binder.

RC-733

GERNSBACK PUBLICATIONS, Inc.
96-98 Park Place, New York, N. Y.

Gentlemen: Enclosed you will find my remittance of \$2.50, for which you are to send me One Copy of the 1934 OFFICIAL RADIO SERVICE MANUAL as soon as it comes off the press. I understand that \$3.50 will be the price of the Manual after it is printed and the pre-publication price of \$2.50 will then be withdrawn. [Send remittance by check or money order; or register letter if it contains cash, currency or unused U. S. postage stamps.]

Name.....

Address.....

City..... State.....

This Offering on Jewell-Weston & National Products Is No Ordinary Event Such Bargains Come Only ONCE in a Lifetime

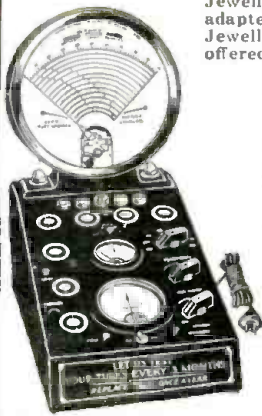

Jewell & Weston Instruments in a Final BIG Close out. Each set furnished with Na-Ald X Y L single adapter. A chart giving full detailed information goes with each checker. Also guarantee card from Jewell Elec. Instrument Co. List price \$125. Lowest price these were ever sold was \$94. Until we offered them for \$39.50 and sold several hundred. The balance are slashed to

\$29.75

Jewell 214 Tube seller—finished in cast aluminum; 9" three color dial meter; a dandy unit. Only 42 left. Special

\$29.75

Jewell 536—In general appearance same as the 538—tests the same tubes as the 538—only 15 left at

\$29.75



Jewell 538 tube seller. This is the one that every dealer wants. Now you can afford two or more at this special price. Only 65 left. Our price only

\$29.75

The 214—536—538 will test the following tubes

2A3	112A	33	42	57	81
2A5	120	34	44	58	82
5Z3	22	35	45	59	83
15	24A	36	46	71A	84
19	26	37	47	75	85
01A	27	38	49	77	89
1	30	39	50	78	UX199
10	31	40	55	80	
WD12	32	41	56		



NAVY TYPE TELEGRAPH KEY

List \$3.60. Navy knob—1/8" Tungsten contacts.

While they last. **\$1.25**

Without navy knob\$1.10

Jewell 534 Panel type tube seller; 36 sockets; List \$164. Only 5 left..... **\$55**

Jewell & Weston Meters
We have a complete stock of panel type instruments at regular wholesale prices. Write for Bulletin of the particular one you are interested in.

Weston 666 Set Analyzer Complete with 6 and 7 prong adapters. List \$115. Only 10 left. Our Special Price

\$55.95

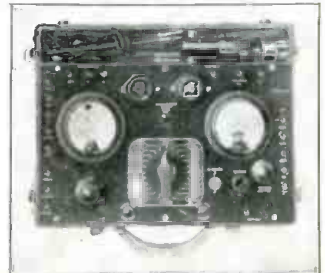

Weston 663 Volt Ohm-meter \$60 list Special **\$44.10**

JEWELL METERS 700 of them, packed and shipped for export. The order was cancelled when the meters were on the pier. We bought them from the exporter. Look over this list for values—all new, factory guaranteed, metal cased instruments.



2" flush mt. List \$7.

No. 135
0-5 v. D.C. }
0-8 " } **\$1.95**
0 10 " }
0-100 " }
0-7 1/2-150 " }

Lowest price ever sold \$4.46

2" flush mt. List \$7.50

No. 190
A.C.-0-1 1/2 v. }
0-3 " } **\$2.95**
0-5 " }
0-8 " }
0-15 " }
0-20 " }
0-150 " }

Lowest price ever sold \$5.63

2" flush mt. List \$7.50 **Lowest price ever sold \$4.46**

No. 135 0-5 M.A. } **\$2.95** } 0-80 M.A.
0-10 M.A. } } 0-100 M.A.
0-15 M.A. } } 0-200 M.A.
0-25 M.A. } } 0-300 M.A.
0-50 M.A. } } 0-500 M.A.
No. 135 0-3 v. 10,000 ohms } **\$2.95 Special**
No. 135 0-4 1/2 v. 15,000 ohms } **\$2.95 Special**
LOWEST PRICE EVER SOLD \$5.88
No. 165 Thermo Couple R. F. Ammeter, \$4.95. List \$12.35; lowest sold \$9.12; 0-1 amp.—0-2 amp.

Standard H. F. National Midget Condenser—

180 Isolantite insulation	
S. T. 50 50 mmf.....	\$1.06
75 75 mmf.....	1.17
100 100 mmf.....	1.33
150 150 mmf.....	1.47

NATIONAL PRODUCTS

We have a complete line in stock—parts, sets for receiving and transmitting. Get our lowest wholesale prices.

National FB 7 Superheterodyne



The Sensational FB 7 Superheterodyne at lowest wholesale prices.
FB 7 Receiver, stripped. **\$26.46**
FBX Crystal filter model. **\$38.22**
With air tuned I. F. **\$42.92**
All coil ranges, each. **\$5.88**
5887 AB Power supply. **\$14.42**
5897 AB Power supply. **\$20.29**



NATIONAL SW
The Popular SW 3 receivers now **3** available in three models—for 2 volt D.C. tubes, 2 1/2 volt A.C. tubes or 6 volt A.C.-D.C. operation. **\$14.42**

Prices reduced to.....
Coils—12 sets ranging from 9 to 2000 meters at 40% and 2% off list price.

National SRR 5 meter. 3 tube set—using a 36 screen grid rec. detector, 37 interruption frequency oscillator and an 89 pentode audio amplifier tube. The receiver requires 6 volts. A supply and a 135 volt B supply—either B batteries or A.C. operated power pack suitable. The National 5886 A.B. power pack will supply both A and B voltages. Set complete less tubes. **\$14.70**
List \$25. Special.....
10-20-40 meter coils, each **\$0.44**
80-100 meter coils, each **1.03**

KENYON Remember there are Kenyon transformers and chokes to fill every amateur and broadcast requirement. We carry a complete line of this equipment and will be glad to furnish bulletins and our lowest wholesale prices on request.

KENYON REPLACEMENT POWER TRANSFORMERS

Provided with universal mounting brackets and convenient soldering lugs. Properly identified.

TYPE KR-1. High voltage, 700 volts C.T., 125 MA; 5 volts, 2 amp.; 2 1/2 volts C.T., 3 amp.; 2 1/2 volts C.T., 10 1/2 amp.	\$2.25
TYPE KR-2. High voltage, 580 volts C.T., 85 MA; 5 volts, 2 amp.; 1 1/2 volts 4.2 amp.; 2.5 C.T., 1.75 amp.; 5 volts C.T., 1.5 amp.	\$1.75
TYPE KR-3. High voltage, 650 volts C.T., 60 MA; 5 volts 2 amp.; 2 1/2 volts C.T., 1.5 amp.; 2 1/2 volts C.T., 8.5 amp.	\$1.75
KR-4. High voltage, 580 volts C.T., 85 MA; 5 volts, 2 amp.; 2 1/2 volts C.T., 1 1/2 amp.; 2 1/2 volts C.T., 7 amp.	\$1.75
KR-5. High voltage, 1100 volts C.T., 150 MA; 7 1/2 volts 2 1/2 amp.; 7 1/2 volts C.T., 2 1/2 amp.; 2 1/2 volts C.T., 10 amp.; 1 1/2 volts, 6.3 amp.	\$3.75
KTT. Fil. trans for tube checkers; voltages available: 1.1-1.5-2.2-3.3-5.0-3.7-5-15-25-30	\$1.75
Plate and Fil. transformer—flush type models	
K-40. For 4 tube midgets; prim. 115 volts, sec. 650 volts, at 40 MA; 5 volts, 2 amp.; 2 1/2 volts C.T., 5 1/2 amp.; electrostatic shield and 2 1/2 volts C.T., grounded.	\$0.95
K-67. For 6 and 7 tube rec. prim., 115 volts, sec. 700 volts, at 40 MA; 5 volts, 2 amp.; 2 1/2 volts C.T., 9 amp.	\$1.75
K-90. For 9 and 10 tube rec. and power amp., prim. 115 volts, sec. 750 volts C.T., 100 MA; 5 volts, 2 amp.; 2 1/2 volts C.T., 4 amp.; 2 1/2 volts C.T., 12 amp.	\$2.00

We do not publish a catalog. Lowest current prices, quoted by return mail on all short wave apparatus. Hundreds of other items at Big Special Prices.

WESTERN ELECTRIC

Signal Corps Type P-11 head phones; never sold below \$7.00 a pair. Now at a typical LEEDS bargain price, per pair, of only **\$3.95**

Genuine Type C Baldwin Phones

\$12.00 List—Mica diaphragm. Limited quantity—only 2 pair to a customer. Special **\$3.75**
Imported 4000 ohm featherweight phones. Special **\$1.35**
Acme 2000 ohm featherweight phones..... **\$1.15**
Acme 4000 ohm featherweight phones..... **1.45**
Kelllogg and Amblion Single-Button Microphones. Ideal for portable transmitter. Extra Special **\$1.75**

General Radio Products

We Carry a Complete Line of Parts in Stock.



45D Vesey Street, New York City
New York Headquarters for Transmitting Apparatus

No More Out-of-Date Equipment with the SIMPLICITY ANALYZER UNIT

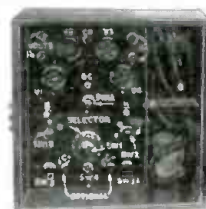

Used with any general purpose meter.
Makes a basically permanent and simple analyzer.

Will test ALL the new tube circuits—like the 6A7 and the 99 XYZ 9 (if and when it comes out).

Complete kit of **\$13.25** Including 3 adapters as shown in analyzer plug adapters and chart article

ACCESSORIES

4 1/2 v. small C battery.....	\$0.31
Tri-Leeds quick-change test leads.....	0.35
Leatherette Portable Case and cover..	2.50
Complete drilled panel available.	

MAIL ORDERS FILLED SAME DAY

C. O. D. Orders Must Be Accompanied by 10% Deposit, Include Postage